

## Contents

### Otology

|   |       |
|---|-------|
| Micro Ear Forceps                           | 22-2  |
| Micro Ear Scissors                          | 22-5  |
| Wire Closure Forceps                        | 22-6  |
| Crura and Malleus Nippers                   | 22-7  |
| Knives                                      | 22-9  |
| Needles, Picks, Hooks                       | 22-10 |
| Dissectors, Elevators, Curettes, Mobilizers | 22-12 |
| Foot Plate Hand Instruments                 | 22-13 |
| Needles, Hooklets                           | 22-14 |
| Suction Tubes                               | 22-17 |
| Ear Specula                                 | 22-18 |
| Tuning Forks                                | 22-21 |
| Eustachian Catheters, Snares                | 22-27 |
| Dressing Forceps                            | 22-28 |
| Polypus Forceps, Foreign Body Forceps       | 22-29 |
| Punches                                     | 22-31 |
| Curettes and Spoons                         | 22-32 |
| Loops, Hooks                                | 22-34 |
| Paracentesis Needles                        | 22-36 |
| Elevators, Raspatories, Curettes            | 22-38 |
| Syringes                                    | 22-40 |

### Rhinology

|  |       |
|--|-------|
| Specula                                | 23-2  |
| Snares                                 | 23-7  |
| Dressing Forceps, Polypus Forceps      | 23-8  |
| Septum Forceps                         | 23-9  |
| Cutting Forceps                        | 23-11 |
| Septum Scissors                        | 23-15 |
| Sphenoid Punches, Antrum Punch Forceps | 23-17 |
| Knives                                 | 23-20 |
| Elevators                              | 23-23 |
| Chisels, Gouges, Osteotomes            | 23-26 |
| Rhinoplastic Instruments               | 23-32 |
| Files and Rasps                        | 23-33 |
| Hooks and Retractors                   | 23-40 |
| Curettes                               | 23-45 |
| Adenoid Curettes                       | 23-46 |
| Wash Cannulas, Wash Catheters, Probes  | 23-49 |
| Sinuscopy Forceps                      | 23-50 |

### Oral, Maxillo-Facial Surgery

|                        |       |
|------------------------|-------|
| Mouth Gags             | 24-2  |
| Cheek Lip Retractors   | 24-7  |
| Tongue Depressors      | 24-8  |
| Tongue Holding Forceps | 24-13 |

|   |       |
|---|-------|
|   | 24-14 |
|   | 24-17 |
| Osteotomes                                  | 24-18 |
| Awls  | 24-18 |
| Disimpaction Forceps                        | 24-20 |
| <br>  |       |
| <b><u>Throat Surgery</u></b>                |       |
| Needles                                     | 25-2  |
| Knives, Ligature Carriers                   | 25-3  |
| Retractors, Enucleators, Dissectors         | 25-4  |
| Tonsil Seizing Forceps                      | 25-7  |
| Tonsil Snares                               | 25-8  |
| Tonsillectomes                              | 25-9  |
| Tonsil Punch Forceps, Tonsil Hemostats      | 25-10 |
| Broncho-Esophagoscopy Forceps               | 25-11 |
| Universal Handles and Interchangeable Tubes | 25-12 |
| Cutting and Grasping Tips                   | 25-13 |
| Endolaryngeal Micro-Surgery Instruments     | 25-14 |
| Forceps for Laryngo-Bronchoscopy            | 25-15 |
| Laryngeal Mirrors                           | 25-16 |
| Laryngeal Polypus Forceps                   | 25-18 |

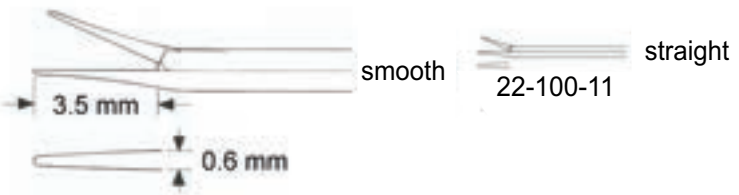
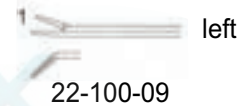
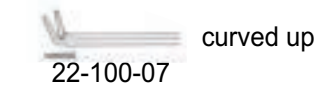
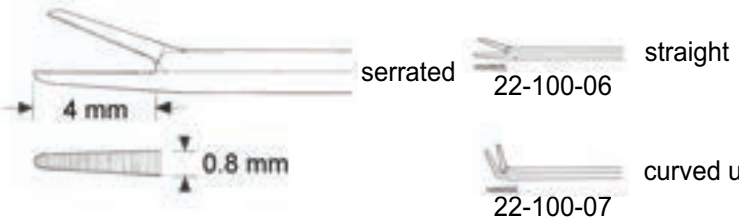
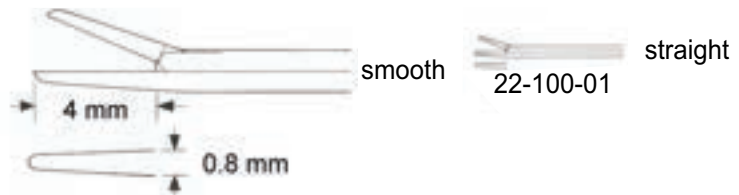




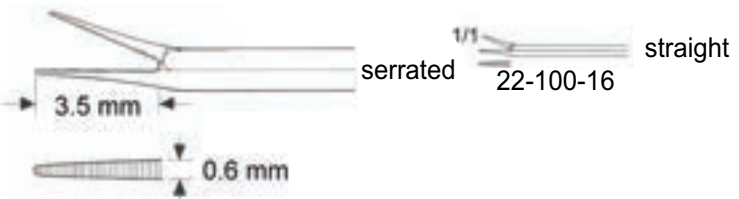
22

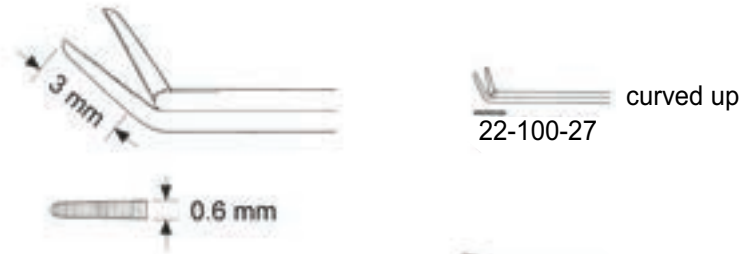
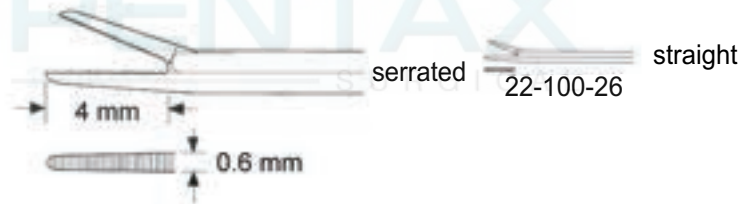
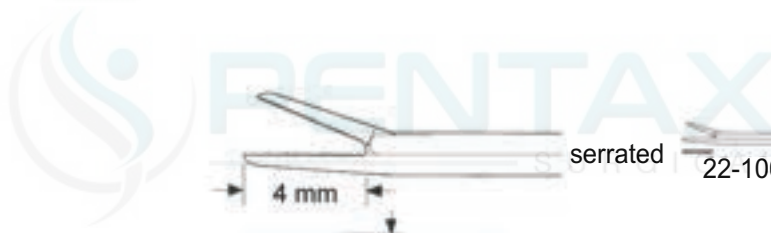
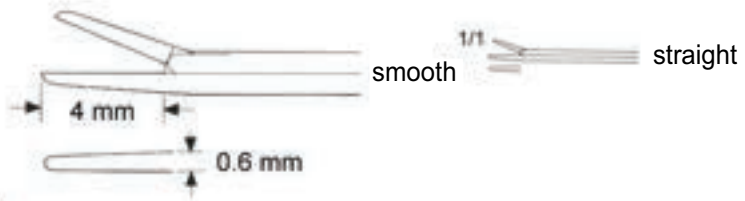
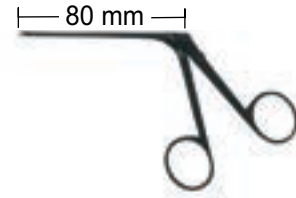


22-100-01 - 22-100-09



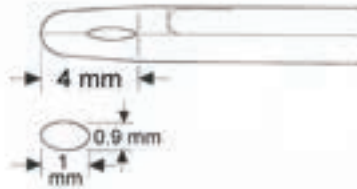
Mini McGee Alligator  
 22-100-11 - 22-100-16







22-102-01 - 22-102-04

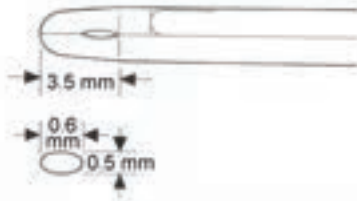


straight  
22-102-01

curved up  
22-102-02

right  
22-102-03

left  
22-102-04



straight  
22-102-11

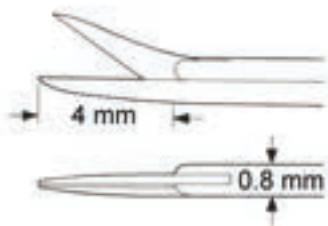
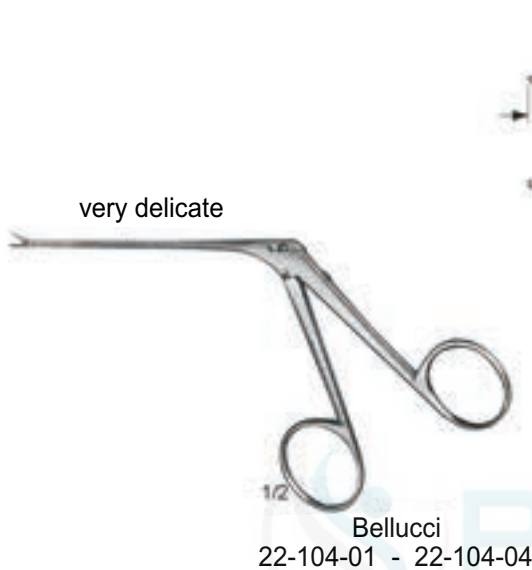
curved up  
22-102-12

right  
22-102-13

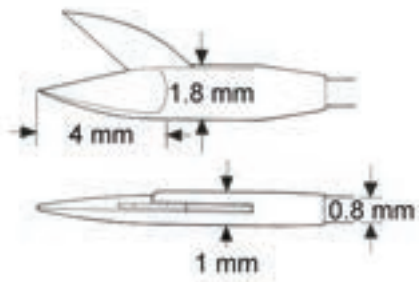
left  
22-102-14



22-102-11 - 22-102-14



- straight  
22-104-01
- curved up  
22-104-02
- right  
22-104-03
- left  
22-104-04



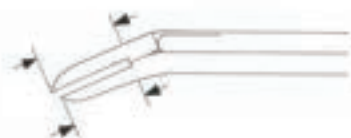
- straight  
22-104-31
- curved up  
22-104-32
- right  
22-104-33
- left  
22-104-34



1/2  
 Greven  
 22-110-01



1/2  
 Schuknecht  
 22-110-06



22-110-11 0.8 x 3.5 mm



22-110-12 0.8 x 6.0 mm



1/2  
 McGee  
 22-110-11 - 22-110-12

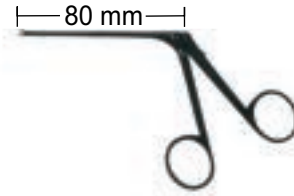


22-110-16  
 left

22-110-17  
 right



1/2  
 Juers  
 22-110-16 - 22-110-17

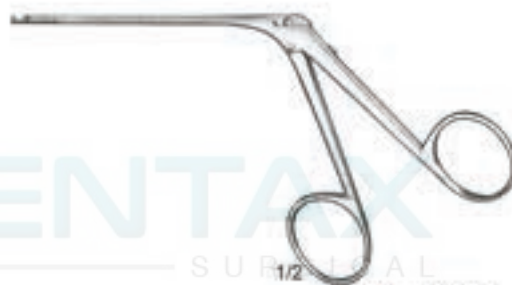


22-112-01 up

22-112-06 right

22-112-02 down

22-112-07 left

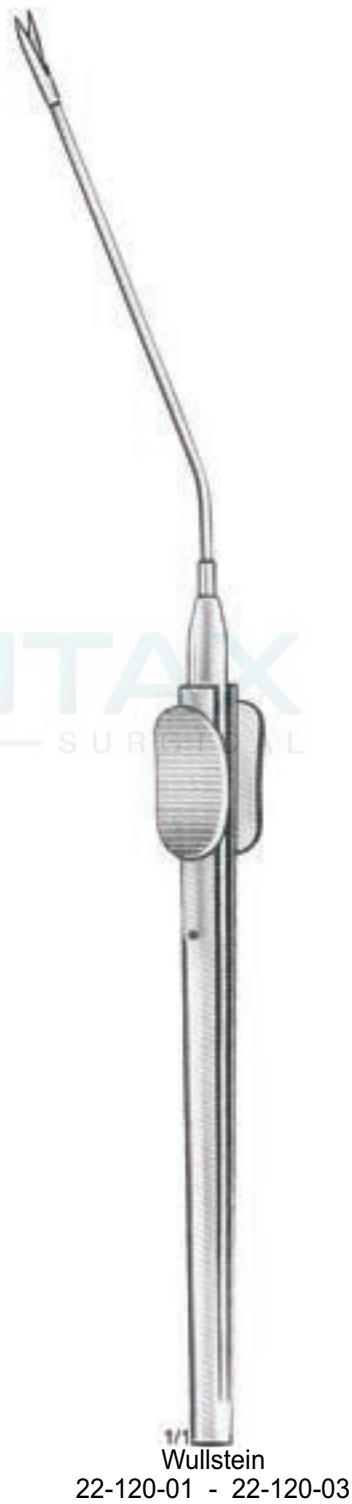
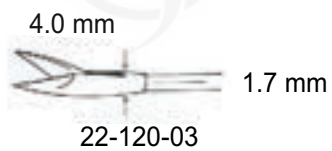
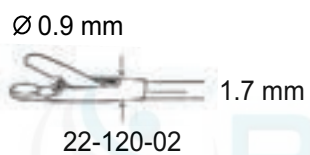
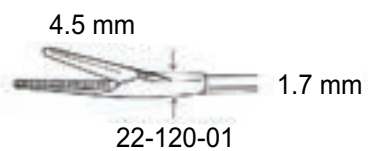


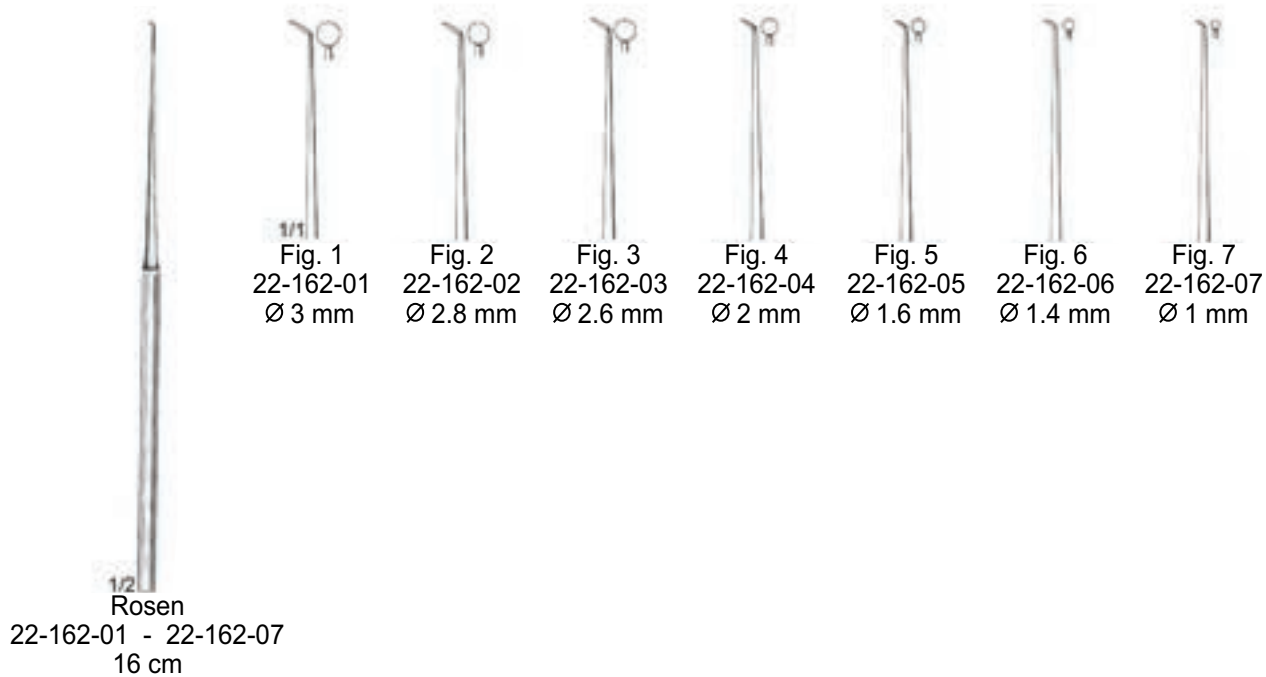
House - Dieter  
 22-112-01 - 22-112-02

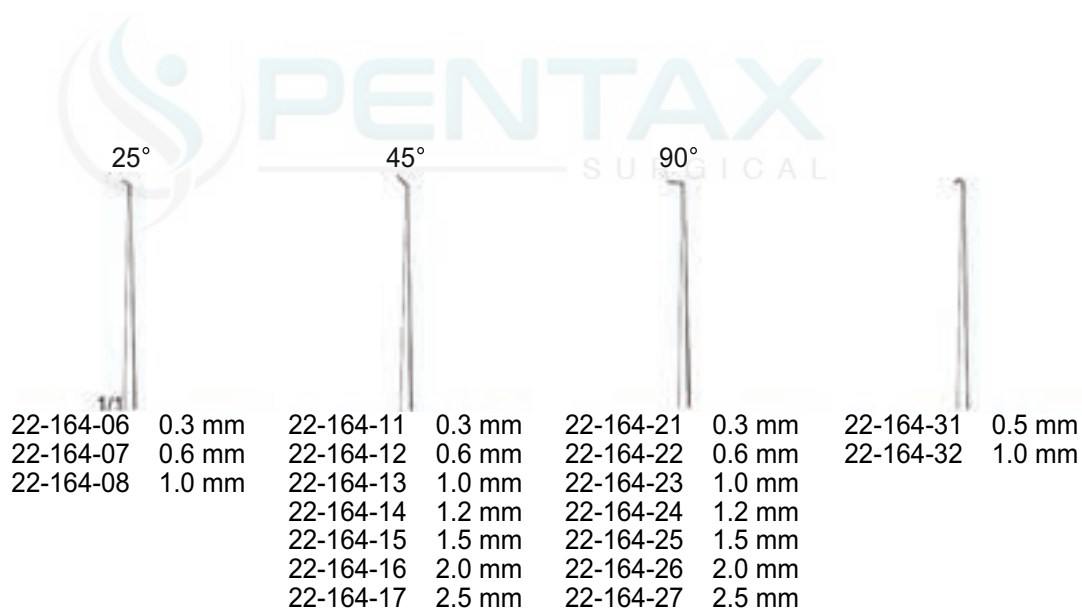
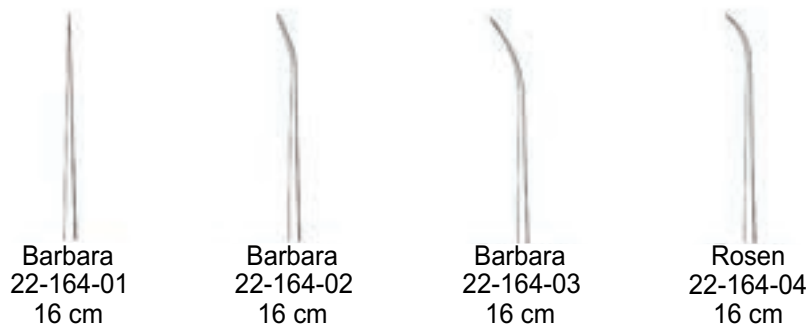
House - Dieter  
 22-112-06 - 22-112-07



Fuller  
 22-114-01









22-164-01 - 22-164-32  
16 cm

25°




|           |        |
|-----------|--------|
| 22-170-03 | 0.3 mm |
| 22-170-06 | 0.6 mm |
| 22-170-10 | 1.0 mm |

45°




|           |        |
|-----------|--------|
| 22-172-03 | 0.3 mm |
| 22-172-06 | 0.6 mm |
| 22-172-10 | 1.0 mm |


90°




|           |        |
|-----------|--------|
| 22-174-03 | 0.3 mm |
| 22-174-06 | 0.6 mm |
| 22-174-10 | 1.0 mm |



|           |        |
|-----------|--------|
| 22-171-03 | 0.3 mm |
| 22-171-06 | 0.6 mm |
| 22-171-10 | 1.0 mm |




|           |        |
|-----------|--------|
| 22-173-03 | 0.3 mm |
| 22-173-06 | 0.6 mm |
| 22-173-10 | 1.0 mm |




|           |        |
|-----------|--------|
| 22-175-03 | 0.3 mm |
| 22-175-06 | 0.6 mm |
| 22-175-10 | 1.0 mm |



22-170-03 - 22-178-01

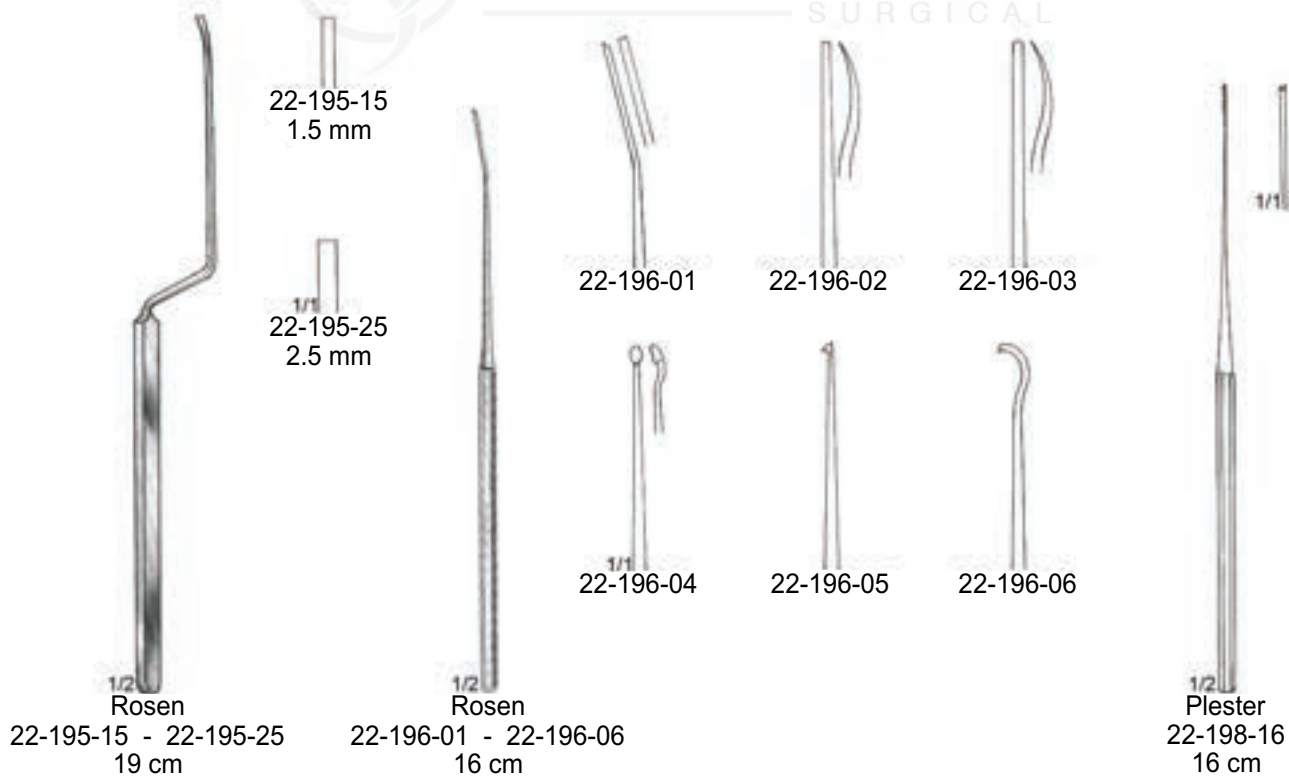
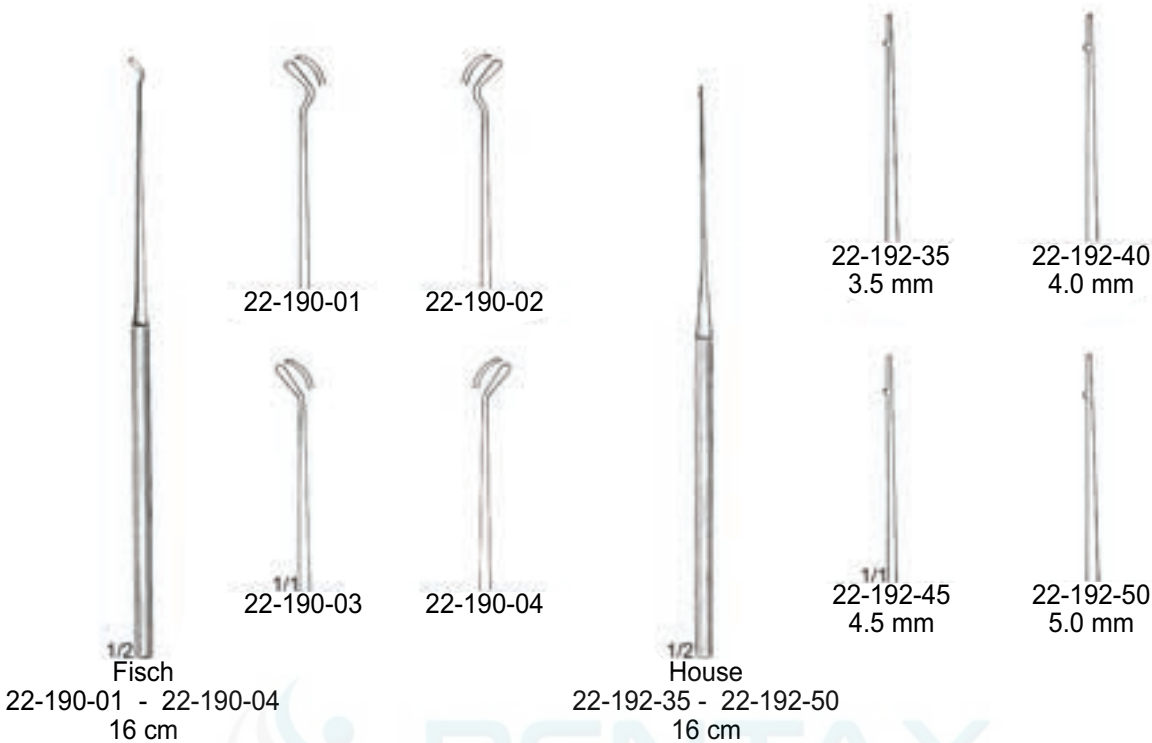


|           |        |
|-----------|--------|
| McGee     |        |
| 22-176-05 | 0.5 mm |
| 22-176-10 | 1.0 mm |



|           |        |
|-----------|--------|
| McGee     |        |
| 22-177-05 | 0.5 mm |
| 22-177-10 | 1.0 mm |







House  
 22-221-01 1.0 + 1.2 mm  
 22-221-02 1.5 + 1.8 mm  
 15 cm



House  
 22-223-01 1.0 + 1.2 mm  
 22-223-02 1.5 + 1.8 mm  
 15 cm



Shea  
 22-226-16  
 16 cm



Shea  
 22-227-16  
 16 cm



22-230-03 - 22-232-03  
 16 cm



Buckingham  
 22-230-01  
 0.5 mm



Buckingham  
 22-230-02  
 1.0 mm



Buckingham  
 22-230-03  
 1.5 mm



Larkin  
 22-232-01  
 Ø 0.8 mm



Larkin  
 22-232-02  
 Ø 0.8 mm



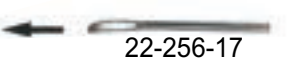
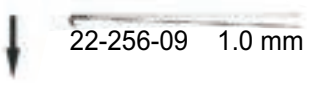
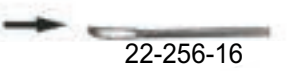
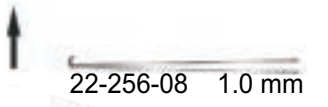
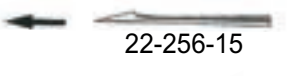
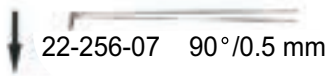
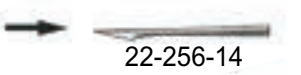
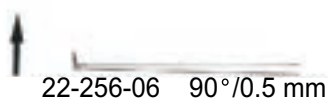
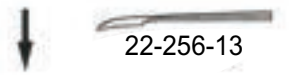
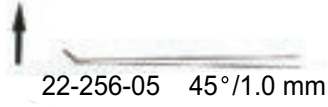
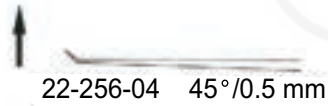
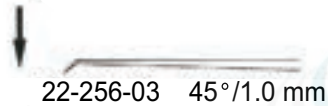
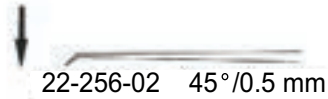
Larkin  
 22-232-03  
 Ø 0.8 mm

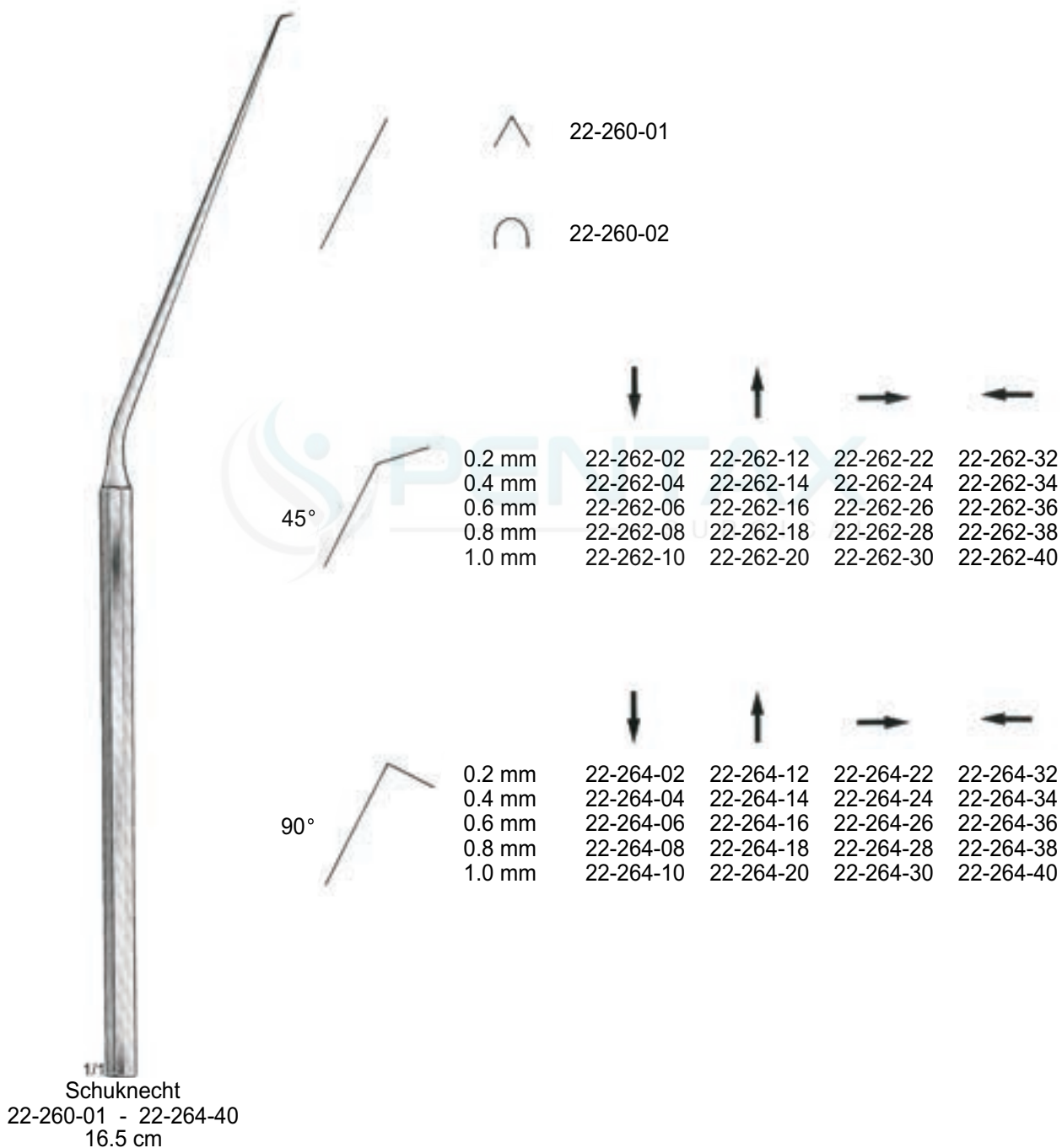




22-256-01

1/1  
 Zollner  
 22-256-01 - 22-256-17  
 13.5 cm





22-260-01

22-260-02

45°

|        |           |           |           |           |
|--------|-----------|-----------|-----------|-----------|
| 0.2 mm | 22-262-02 | 22-262-12 | 22-262-22 | 22-262-32 |
| 0.4 mm | 22-262-04 | 22-262-14 | 22-262-24 | 22-262-34 |
| 0.6 mm | 22-262-06 | 22-262-16 | 22-262-26 | 22-262-36 |
| 0.8 mm | 22-262-08 | 22-262-18 | 22-262-28 | 22-262-38 |
| 1.0 mm | 22-262-10 | 22-262-20 | 22-262-30 | 22-262-40 |

90°

|        |           |           |           |           |
|--------|-----------|-----------|-----------|-----------|
| 0.2 mm | 22-264-02 | 22-264-12 | 22-264-22 | 22-264-32 |
| 0.4 mm | 22-264-04 | 22-264-14 | 22-264-24 | 22-264-34 |
| 0.6 mm | 22-264-06 | 22-264-16 | 22-264-26 | 22-264-36 |
| 0.8 mm | 22-264-08 | 22-264-18 | 22-264-28 | 22-264-38 |
| 1.0 mm | 22-264-10 | 22-264-20 | 22-264-30 | 22-264-40 |

Schuknecht  
 22-260-01 - 22-264-40  
 16.5 cm



| House     |              |
|-----------|--------------|
| 22-300-09 | 0.9 + 0.7 mm |
| 22-300-12 | 1.2 + 0.9 mm |
| 22-300-15 | 1.5 + 1.2 mm |
| 22-300-18 | 1.8 + 1.8 mm |
| 22-300-25 | 2.5 + 2.0 mm |
| 22-300-30 | 3.0 + 2.0 mm |
| 22-300-45 | 4.5 + 2.0 mm |



| Baron (Schuknecht) |             |
|--------------------|-------------|
| 22-302-10          | 1.0 x 75 mm |
| 22-302-15          | 1.5 x 75 mm |
| 22-302-20          | 2.0 x 75 mm |



Zollner  
22-305-00



22-305-05 Ø 0.5 mm  
 22-305-07 Ø 0.7 mm



Wullstein  
22-306-00



Wullstein  
22-307-00



| House     |        |
|-----------|--------|
| 22-308-06 | 0.6 mm |
| 22-308-08 | 0.8 mm |
| 22-308-10 | 1.0 mm |
| 22-308-12 | 1.2 mm |
| 22-308-15 | 1.5 mm |
| 22-308-18 | 1.8 mm |
| 22-308-20 | 2.0 mm |
| 22-308-22 | 2.2 mm |
| 22-308-25 | 2.5 mm |
| 22-308-30 | 3.0 mm |

Ø = inside diameter



mm  
2.0  
3.0  
3.5  
4.0  
5.0  
6.5  
7.5

Politzer  
22-401-01  
22-401-02  
22-401-03  
22-401-04

Hartmann  
22-405-00  
22-405-01  
22-405-02

Hartmann  
22-409-01  
22-409-02  
22-409-03  
22-409-04

Set 1 - 3  
22-400-03

for children  
Set 0 - 2  
22-404-03

for adults  
Set 2 - 4  
22-408-03  
Set 1 - 4  
22-408-04



mm  
3.0  
4.0  
4.5  
5.0  
5.5  
6.5  
7.0

Hartmann  
22-411-00  
22-411-01  
22-411-02  
22-411-03

Toynee  
22-415-01  
22-415-02  
22-415-03  
22-415-04

Gruber  
22-419-01  
22-419-02  
22-419-03  
22-419-04

black  
Set 0 - 3  
22-410-03

Set 2 - 4  
22-414-03  
Set 1 - 4  
22-414-04

Set 1 - 4  
22-418-04

Aluminium black



Zollner  
22-420-00

Set 1 - 6



22-421-01  
5.5 x 6.5 mm



22-421-02  
6.5 x 7.5 mm



22-421-03  
7.5 x 8.5 mm



22-421-04  
8.5 x 9.5 mm



22-421-05  
9.5 x 10.5 mm



22-421-06  
10.5 x 11.5 mm



Boucheron  
22-424-00

Set 1 - 4



22-425-01  
3.5 mm



22-425-02  
4.5 mm



22-425-03  
5.5 mm



22-425-04  
6.5 mm



Farrior  
22-430-33 - 22-435-75



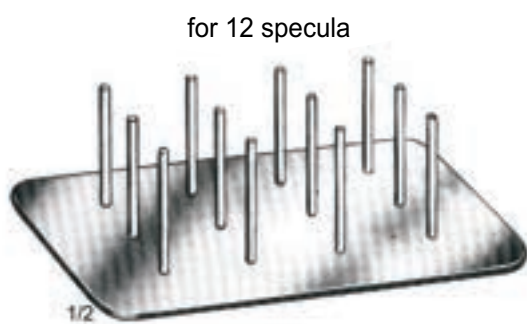
20°



35°



|          |           |                |           |           |           |
|----------|-----------|----------------|-----------|-----------|-----------|
| ○ 3.3 mm | 22-430-33 | ○ 3.0 x 4.0 mm | 22-432-30 | 22-433-30 | 22-435-30 |
| ○ 4.3 mm | 22-430-43 | ○ 4.0 x 5.0 mm | 22-432-40 | 22-433-40 | 22-435-40 |
| ○ 4.8 mm | 22-430-48 | ○ 4.5 x 5.5 mm | 22-432-45 | 22-433-45 | 22-435-45 |
| ○ 5.3 mm | 22-430-53 | ○ 5.0 x 6.0 mm | 22-432-50 | 22-433-50 | 22-435-50 |
| ○ 5.8 mm | 22-430-58 | ○ 5.5 x 6.5 mm | 22-432-55 | 22-433-55 | 22-435-55 |
| ○ 6.3 mm | 22-430-63 | ○ 6.0 x 7.0 mm | 22-432-60 | 22-433-60 | 22-435-60 |
| ○ 6.7 mm | 22-430-67 | ○ 6.5 x 7.5 mm | 22-432-65 | 22-433-65 | 22-435-65 |
| ○ 7.2 mm | 22-430-72 | ○ 7.0 x 8.0 mm | 22-432-70 | 22-433-70 | 22-435-70 |
| ○ 7.7 mm | 22-430-77 | ○ 7.5 x 8.5 mm | 22-432-75 | 22-433-75 | 22-435-75 |



22-450-12



Richnau Holmgren  
22-456-02 Ø 2 mm  
22-456-04 Ø 4 mm  
22-456-06 Ø 6 mm





C 128



Hartmann  
22-492-01

C<sup>1</sup>256



Hartmann  
22-492-02

C<sup>2</sup>512



Hartmann  
22-492-03

C<sup>3</sup>1024



Hartmann  
22-492-04

C<sup>4</sup>2048



Hartmann  
22-492-05

C<sup>5</sup>4096



Hartmann  
22-492-06

C 128



1/2  
Lucae  
22-496-01

C'256



1/2  
Lucae  
22-496-02

C<sup>2</sup>512



1/2  
Lucae  
22-496-03

C<sup>3</sup>1024



1/2  
Lucae  
22-496-04

C<sup>4</sup>2048



1/2  
Lucae  
22-496-05

C<sup>5</sup>4096



1/2  
Lucae  
22-496-06



with clamps C 64  
 without clamps C 128



1/2  
 Rydel - Seiffer  
 22-530-00



1/2  
 22-534-00

A 109





1/2  
 Koenig  
 22-538-00

A'440



1/2  
 22-542-00



-  Fig. 1 22-550-01
-  Fig. 2 22-550-02
-  Fig. 3 22-550-03

Hartmann  
 22-550-01 - 22-550-03  
 15 cm

open tip



Krause  
 22-571-16  
 18.5 cm

close tip



Krause - Voss  
 22-573-16  
 18.5 cm



10 m / 33 ft.

22-578-30  
 Ø 0.3 mm

22-578-40  
 Ø 0.4 mm

bundle of 1 dozen each



22-579-20  
 Ø 0.2 mm



Troeltsch ( Wilde )  
22-601-11  
11 cm



Troeltsch ( Wilde )  
22-603-12  
12 cm



Troeltsch ( Wilde )  
22-605-13  
13 cm



Lucae  
22-607-14  
14 cm



Jansen  
22-609-16 16 cm  
22-609-20 20 cm



Littauer  
 22-621-12  
 12 cm



Hartmann  
 22-625-12  
 12 cm

fine pattern



Hartmann  
 22-627-14  
 14 cm

standard pattern



Buck  
 22-632-11  
 11.5 cm



Quire  
 22-636-10  
 10.5 cm



Hartmann - Wullstein  
22-650-08  
8.5 cm



o 1 mm  
Hartmann - Wullstein  
22-652-08  
8.5 cm



Hartmann  
22-654-08 8.5 cm  
22-654-14 14.0 cm  
22-654-16 16.5 cm



Hartmann  
22-656-08 8.5 cm  
22-656-14 14.0 cm  
22-656-16 16.5 cm



Hartmann - Noyes  
22-658-09  
9 cm



Hartmann - Noyes  
22-660-09  
9 cm



Hartmann - Weingartner  
22-662-08  
8.5 cm



Hartmann  
22-664-08  
8.5 cm

- 2.0 mm
- 2.5 mm
- 3.0 mm



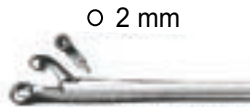
Hartmann  
22-666-20 Ø 2.0 mm  
22-666-25 Ø 2.5 mm  
22-666-30 Ø 3.0 mm  
8.5 cm



Hartmann  
22-668-20 Ø 2.0 mm  
22-668-25 Ø 2.5 mm  
22-668-30 Ø 3.0 mm  
8.5 cm






Struempel  
22-670-08  
8.5 cm




○ 2 mm  
Hartmann - Hoffmann  
22-672-08  
8.5 cm



22-650-08 - 22-672-08

 22-690-17 1 mm  
 22-692-17 2 mm  
 22-694-17 3 mm

 2 mm

 1 mm



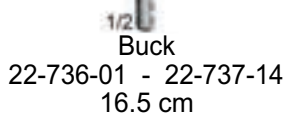
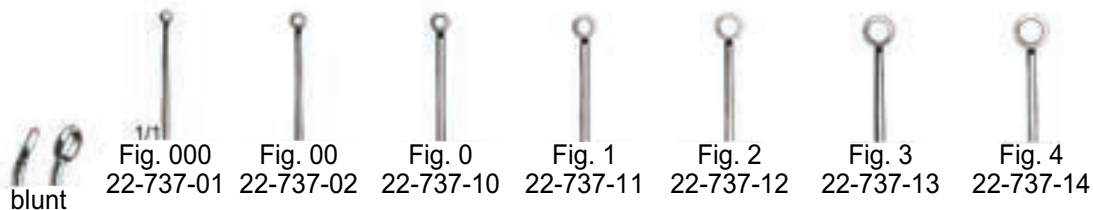
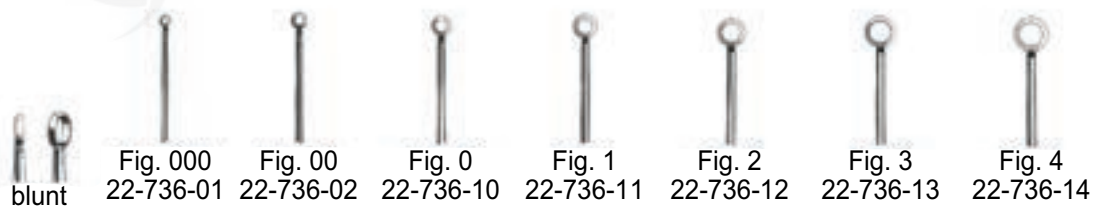
Citelli  
22-690-17 - 22-694-17

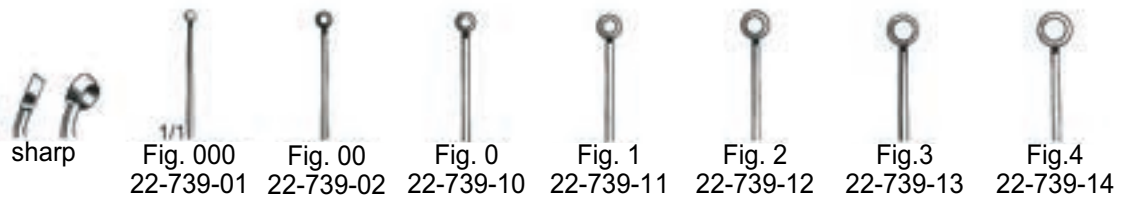
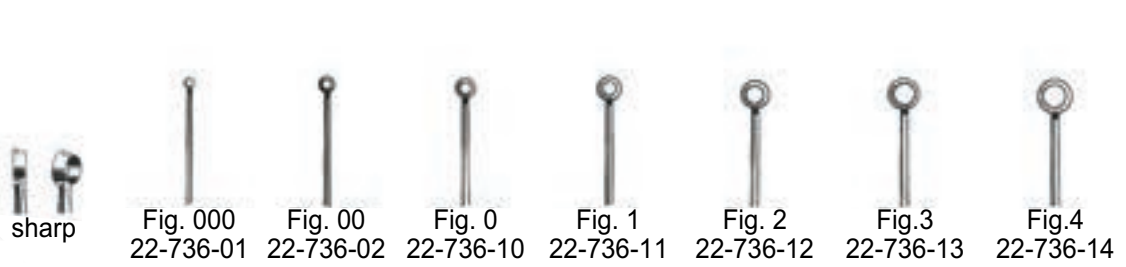


Beyer  
22-698-19



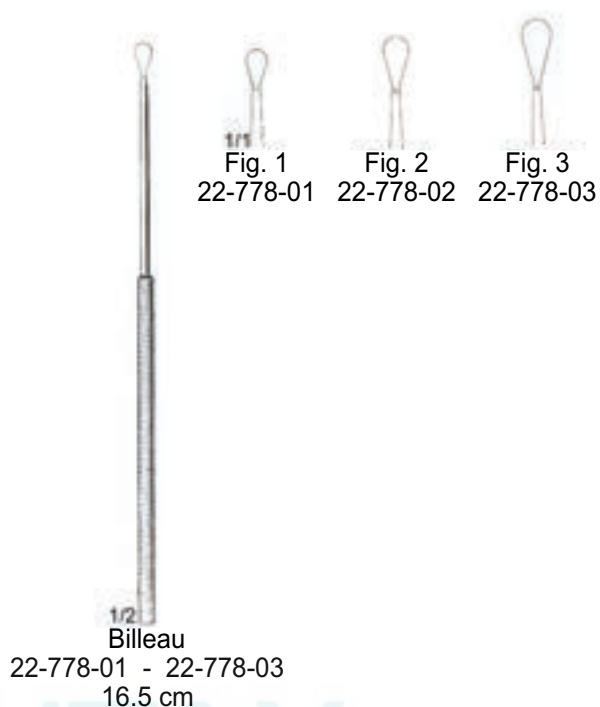
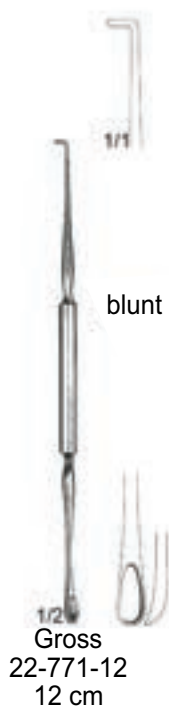
Beyer  
22-702-14





1/2  
 Buck  
 22-738-00 - 22-739-14  
 16.5 cm







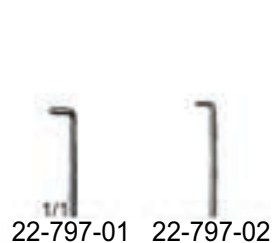
22-790-01



22-790-02



22-793-01 22-793-02 22-793-03

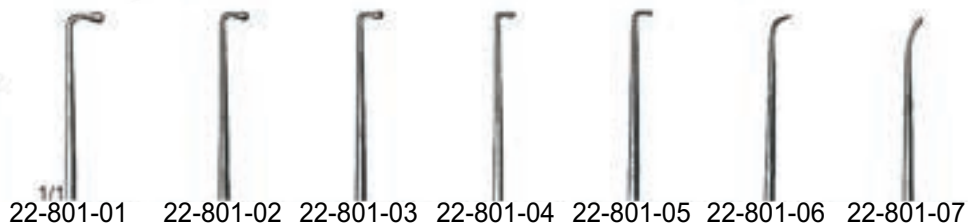


22-797-01 22-797-02

1/2  
 Snellen  
 22-790-01 - 22-790-02  
 16.5 cm

1/2  
 Lucae  
 22-793-01 - 22-793-03  
 14 cm

1/2  
 Day  
 22-797-01 - 22-797-02  
 16 cm



1/2  
 Wagener  
 22-801-01 - 22-801-07  
 14 cm





Politzer  
 22-811-16  
 16 cm



Buck  
 22-813-15  
 15 cm



Sexton  
 22-816-18  
 18 cm



Sexton  
 22-817-17  
 17 cm



Gerzog - Sexton  
 22-821-17  
 17 cm



Politzer  
 22-824-16  
 16 cm



Politzer  
 22-827-16  
 16.5 cm



Politzer  
 22-829-16  
 16.5 cm



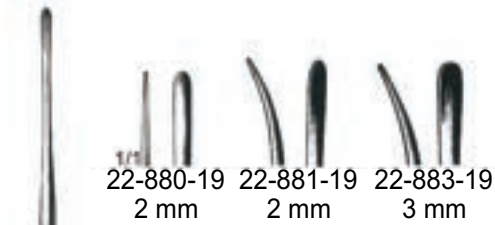
Lucae  
 22-833-18  
 18 cm



Lucae  
 22-835-18  
 18 cm

Ear Operating Set





22-880-19 2 mm    22-881-19 2 mm    22-883-19 3 mm



1/2  
 Lempert  
 22-887-20  
 20.5 cm

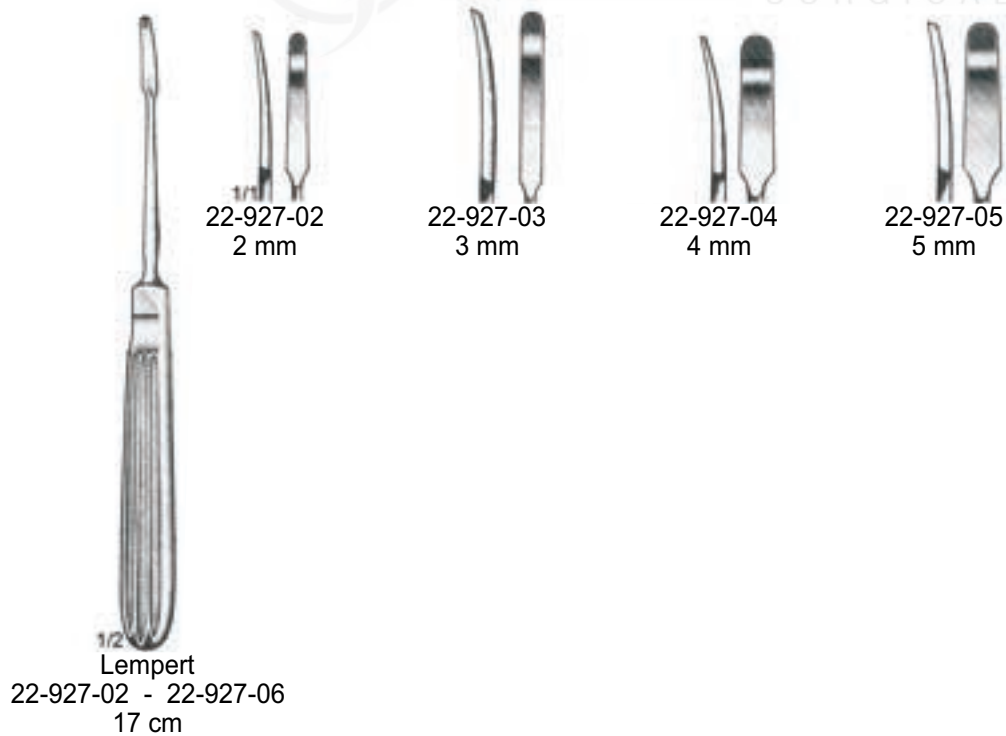


1/2  
 Lempert  
 22-889-18  
 18 cm

1/2  
 Lempert  
 22-880-19 - 22-883-19  
 19 cm



1/2  
 Lempert  
 22-893-10 - 22-893-50  
 17.5 cm



Valve connection    Suction nozzle    Protecting disk



22-944-02



22-944-03



22-944-04

Metal olive    Conical tip    Button ended tip    Threaded tip



22-944-06



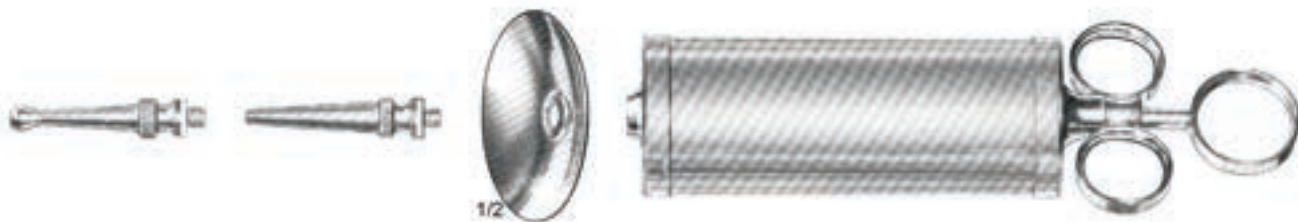
22-944-07



22-944-08



22-944-09



22-945-00    50 ml  
 22-945-04    100 ml

Ear Syringe, complete



23



Fig. 1  
 23-101-01  
 21 x 9.5 mm



Fig. 2  
 23-101-02  
 21 x 10.5 mm



Fig. 3  
 23-101-03  
 21 x 11.5 mm



Fig. 1  
 23-105-01



Fig. 2  
 23-105-02



Fig. 3  
 23-105-03



Thudicum (Goldsmith)  
 23-101-01 - 23-101-03  
 6.5 cm



Voltolini (Duplay)  
 23-105-01 - 23-105-03



Hartmann - Halle  
 23-109-01 - 23-109-03  
 15 cm



Fig. 1  
 23-109-01  
 27 mm



Fig. 2  
 23-109-02  
 31 mm



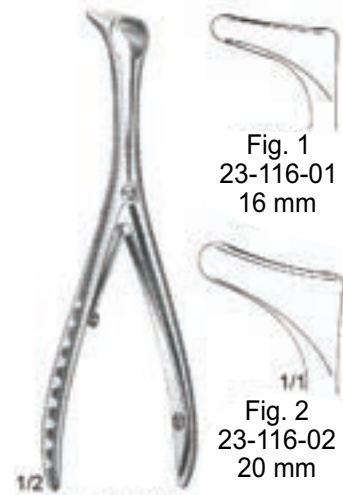
Fig. 3  
 23-109-03  
 35 mm



Beckmann  
 23-112-13  
 13 cm



Beckmann  
 23-113-13  
 13 cm



Tieck - Halle  
 23-116-01 - 23-116-02  
 13.5 cm

Fig. 1  
 23-116-01  
 16 mm

Fig. 2  
 23-116-02  
 20 mm



Killian  
 23-120-01 - 23-120-04  
 13 cm

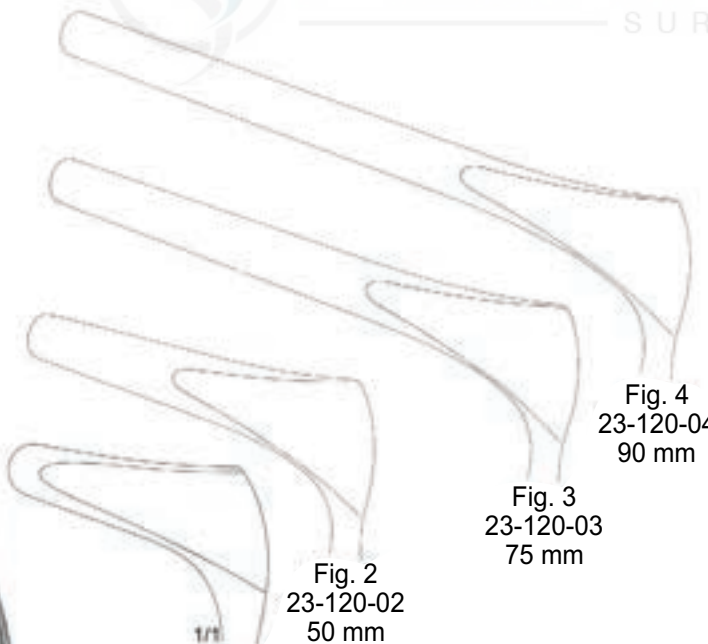
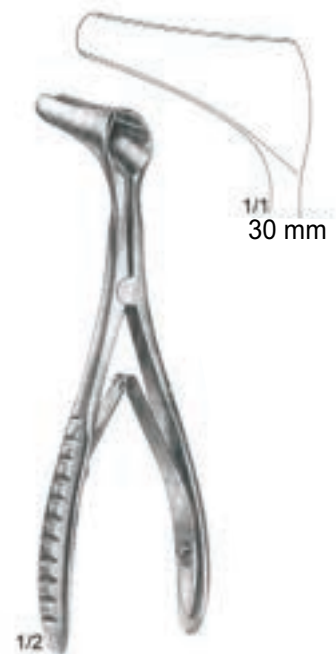


Fig. 1  
 23-120-01  
 35 mm

Fig. 2  
 23-120-02  
 50 mm

Fig. 3  
 23-120-03  
 75 mm

Fig. 4  
 23-120-04  
 90 mm



Mod. Wien  
 23-122-14  
 14.5 cm

1/1  
 30 mm

Dull black chromium plated



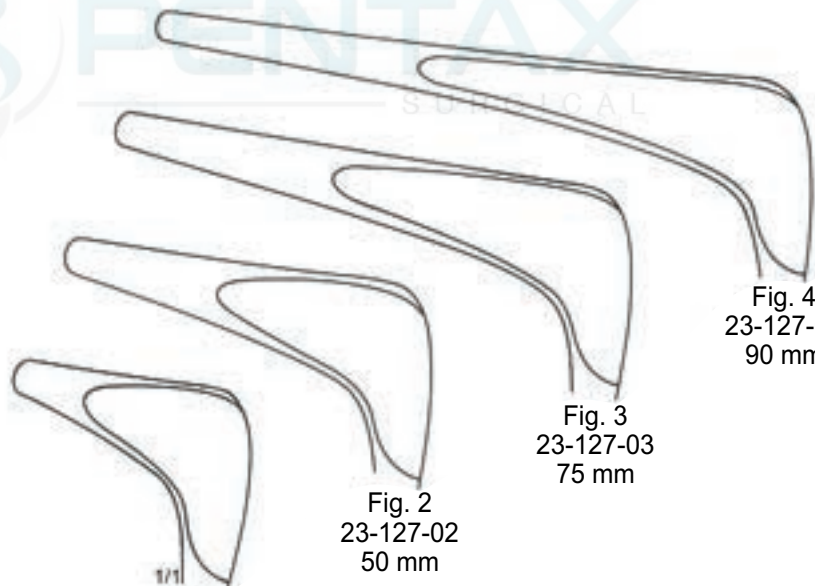
1/2  
 Cottle  
 23-125-01 - 23-125-02  
 14 cm



Fig. 2  
 23-125-02  
 75 mm  
 1/1  
 Fig. 1  
 23-125-01  
 45 mm



1/2  
 Cottle  
 23-127-01 - 23-127-04  
 15 cm



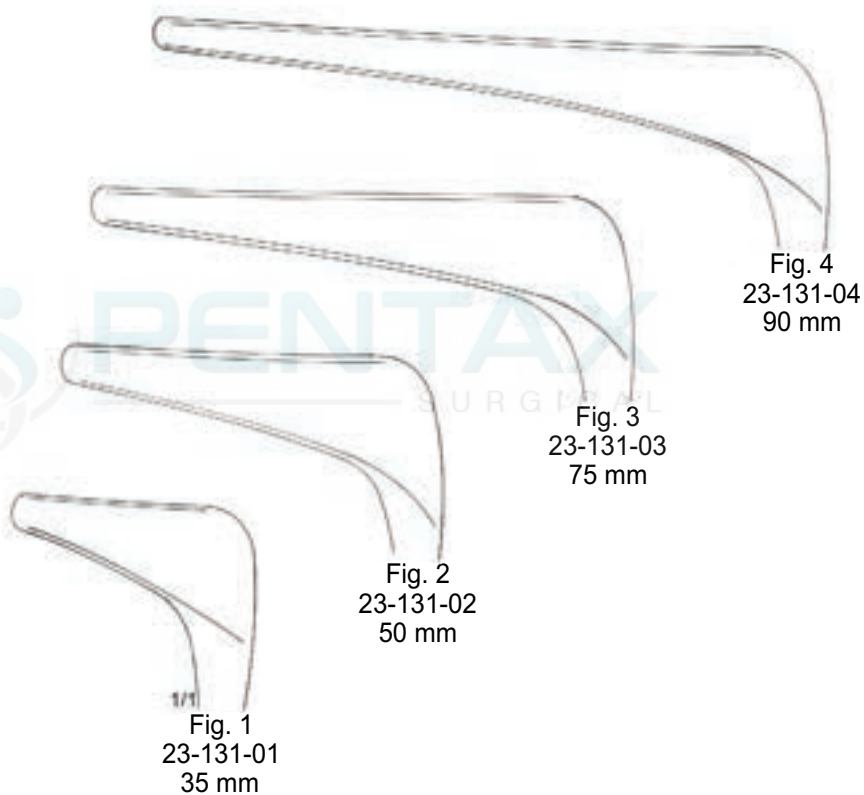
1/1  
 Fig. 1  
 23-127-01  
 35 mm

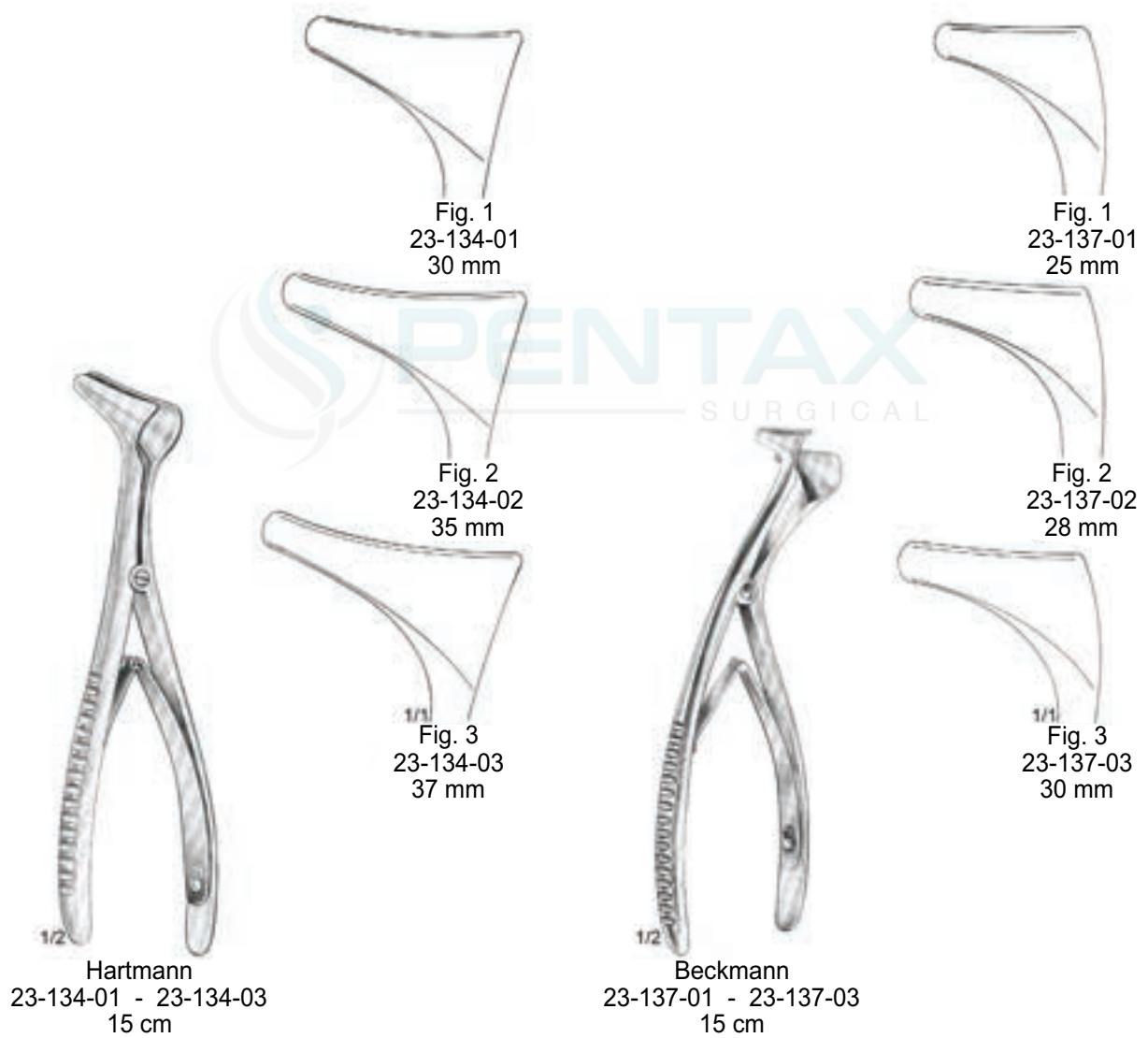
Fig. 2  
 23-127-02  
 50 mm

Fig. 3  
 23-127-03  
 75 mm

Fig. 4  
 23-127-04  
 90 mm

with fixing screw







1/2  
 Krause  
 23-161-26  
 26 cm



1/2  
 Krause - Voss  
 23-165-26  
 26 cm

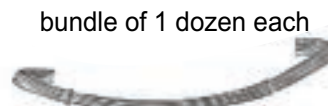


1/2  
 Lange - Wilde  
 23-169-24  
 24 cm



1/3  
 23-176-30 Ø 0.3 mm  
 23-176-40 Ø 0.4 mm

10 m / 33 ft



bundle of 1 dozen each

23-177-12  
 Ø 0.3 mm



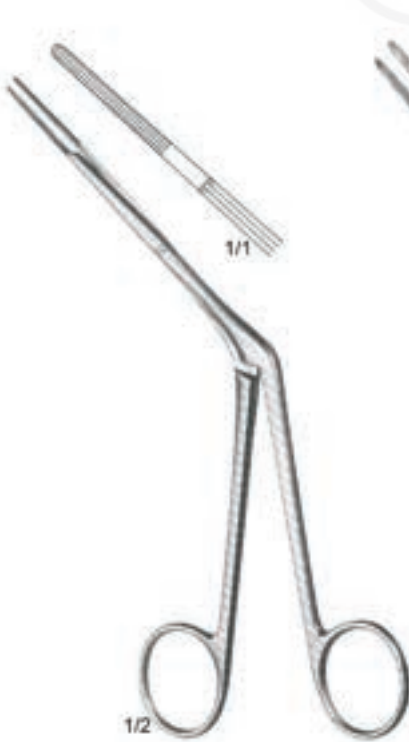
1/2  
Troeltsch  
23-191-15  
15 cm



1/2  
Troeltsch  
23-195-18  
18 cm



1/2  
Gruenwald (Jansen)  
23-199-20  
20 cm



1/2  
Westmacott  
23-211-20  
20 cm



1/2  
Lubet - Barbon  
23-213-20  
20 cm



1/2  
Hartmann  
23-215-16  
16 cm



1/2  
Heymann - Knight  
23-217-18  
18 cm



Hartmann  
 23-221-20  
 20 cm



Littauer  
 23-225-18  
 18 cm



Killian  
 23-229-17  
 17 cm



23-235-01

23-235-02

23-235-03



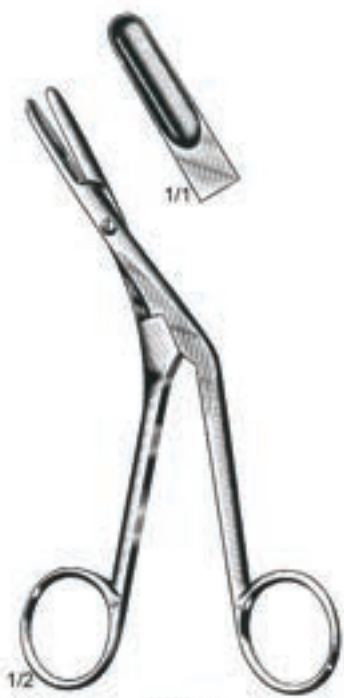
Quire  
 23-231-12  
 12 cm



Heymann  
 23-235-01 - 23-235-03  
 18 cm



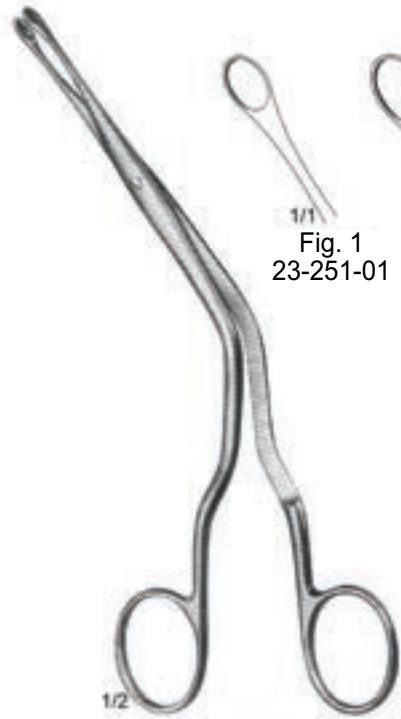
Knight  
 23-239-18  
 18 cm



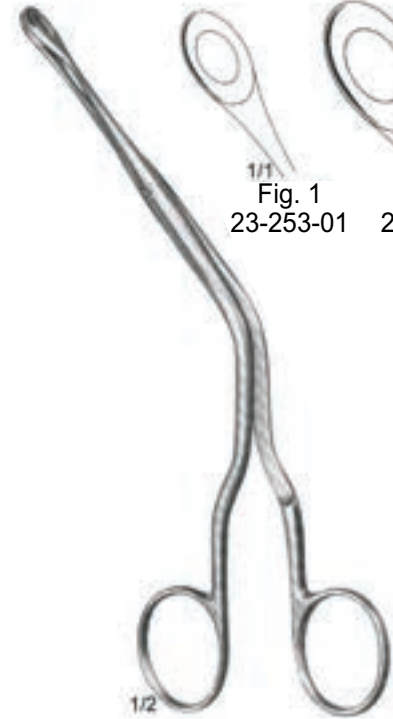
Graig  
 23-243-18  
 18 cm



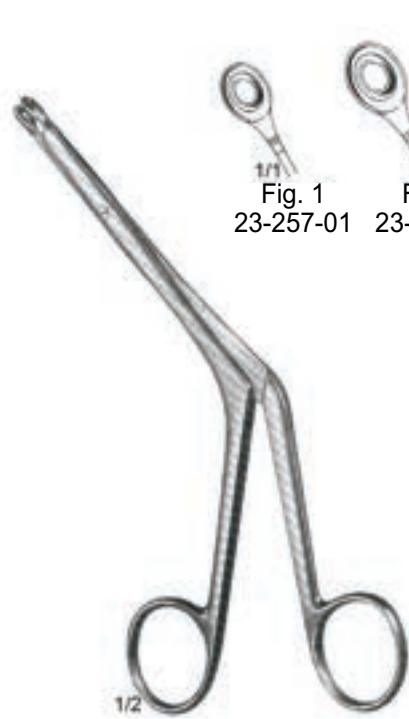
Graig - Domnick  
 23-247-01 - 23-247-02  
 18 cm



Luc  
 23-251-01 - 23-251-02  
 20 cm



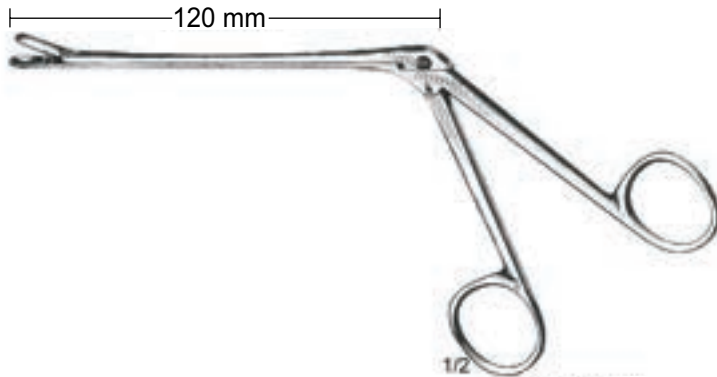
Luc  
 23-253-01 - 23-253-02  
 20 cm



Bruenings  
 23-257-01 - 23-257-04  
 19 cm

Fig. 1 23-253-01 Fig. 2 23-253-02

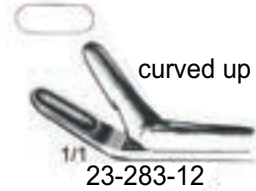
Fig. 1 23-257-01 Fig. 2 23-257-02 Fig. 3 23-257-03 Fig. 4 23-257-04



Takahashi  
23-281-12 - 23-283-12  
19 cm



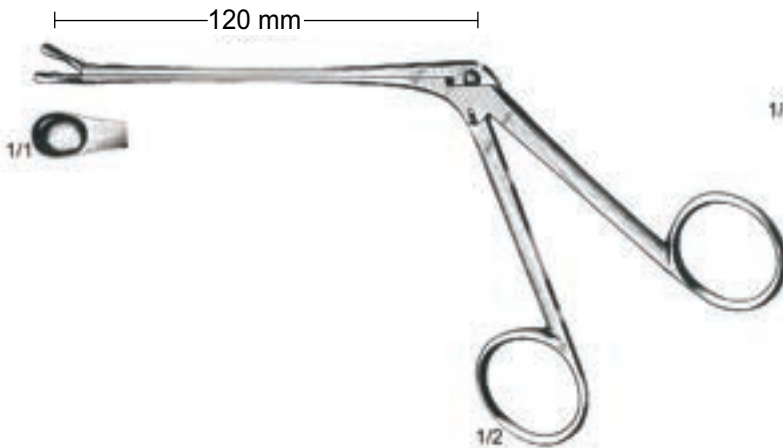
straight  
23-281-12



curved up  
23-283-12








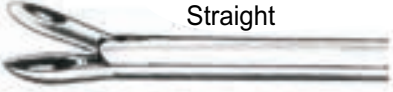

Weil  
23-289-12

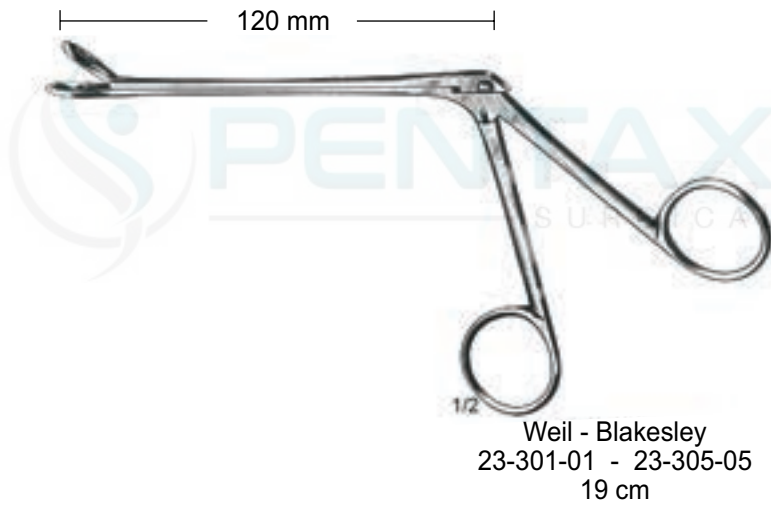


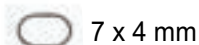
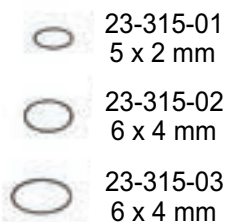
23-287-12  
19 cm



Watson - Williams  
23-293-12

|  |  Fig. 1<br>3.0 mm |  Fig. 2<br>3.5 mm |  Fig. 3<br>4.5 mm |  Fig. 4<br>5.0 mm |  Fig. 5<br>5.5 mm |
|--|--|--|--|--|--|
| <b>Straight</b><br> | 23-301-01  | 23-301-02  | 23-301-03  | 23-301-04  | 23-301-05  |
| <b>45°</b><br>      | 23-303-01  | 23-303-02  | 23-303-03  | 23-303-04  | 23-303-05  |
| <b>90°</b>   | 23-305-01  | 23-305-02  | 23-305-03  | 23-305-04  | 23-305-05  |





**Hartmann**  
 23-311-05 - 23-311-11  
 19 cm



**Gruenwald**  
 23-315-01 - 23-315-03  
 19 cm



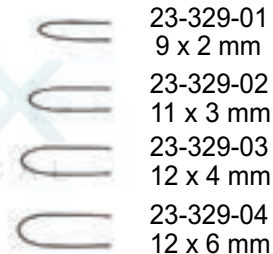
**Gruenwald**  
 23-317-01  
 19 cm



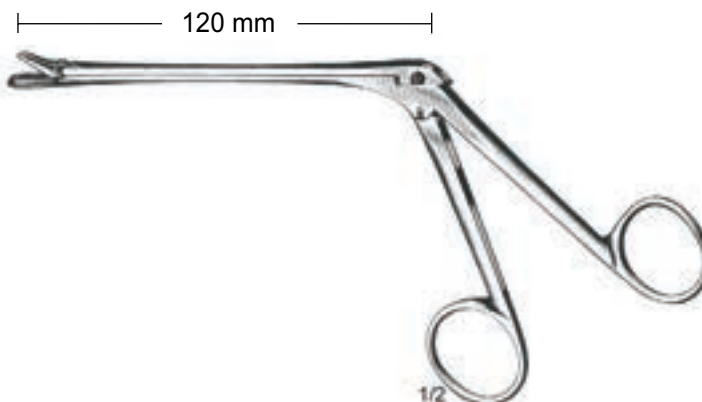
**Schmeden**  
 23-321-01 - 23-321-03  
 19 cm

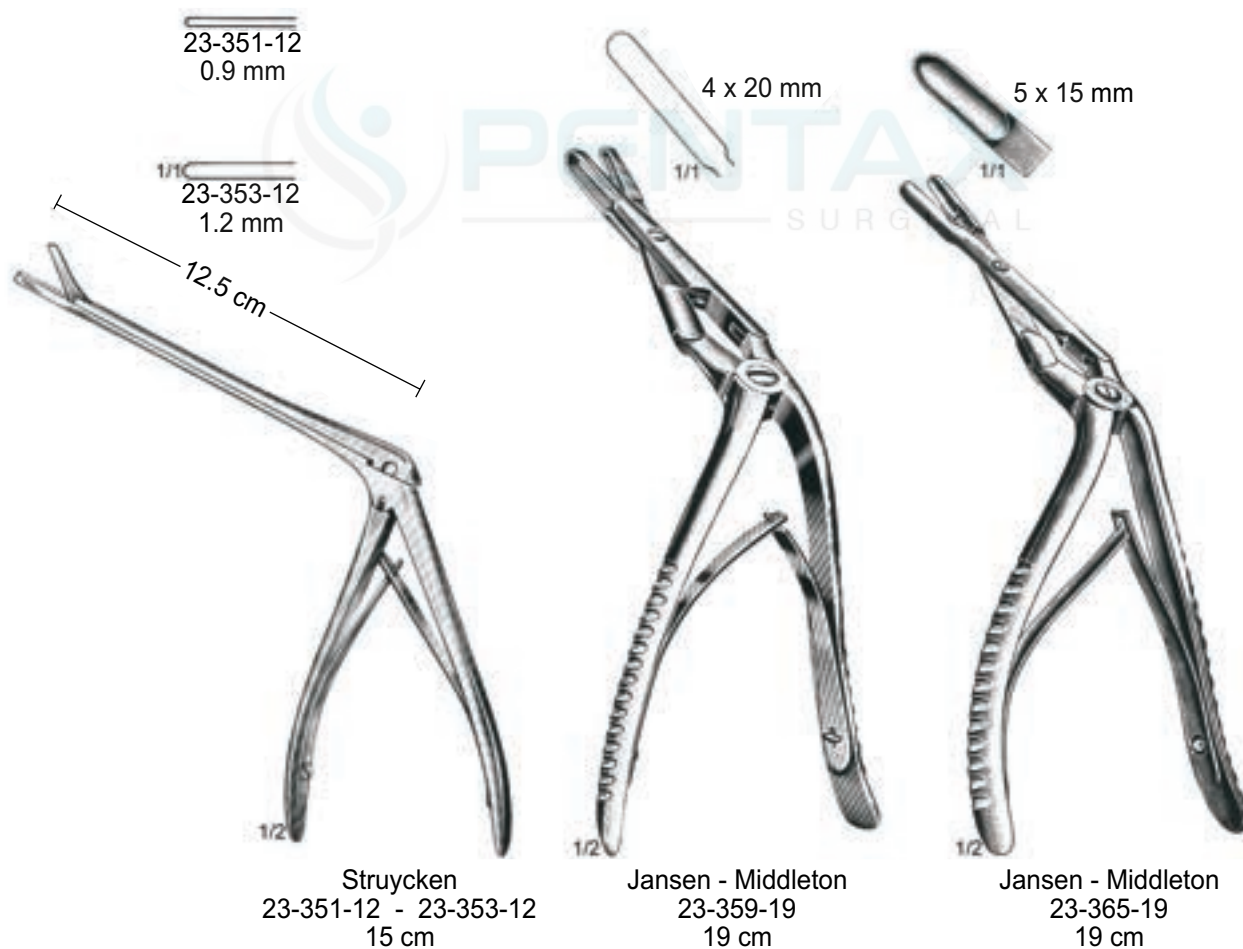


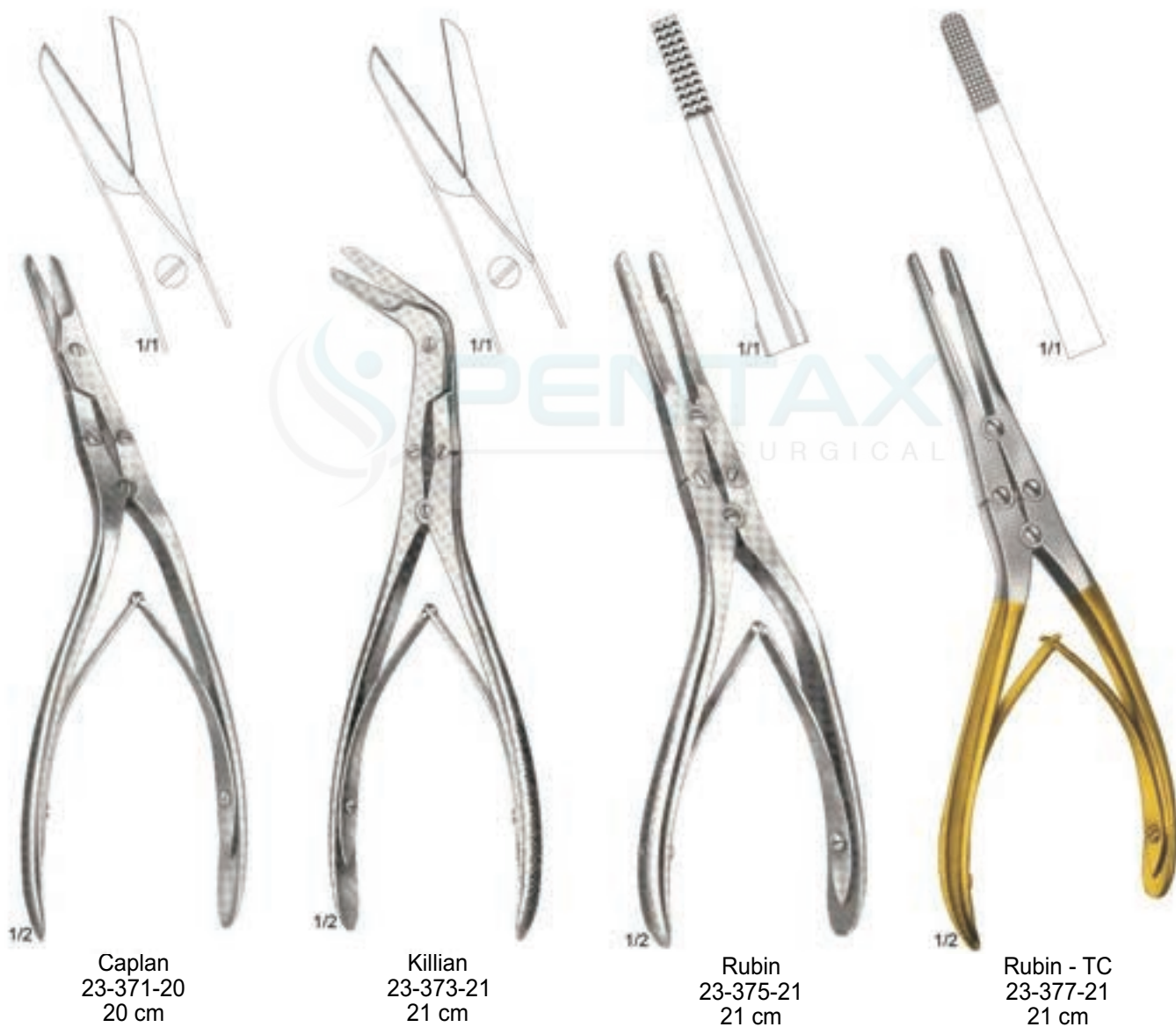
**Hajek**  
 23-325-12  
 19 cm



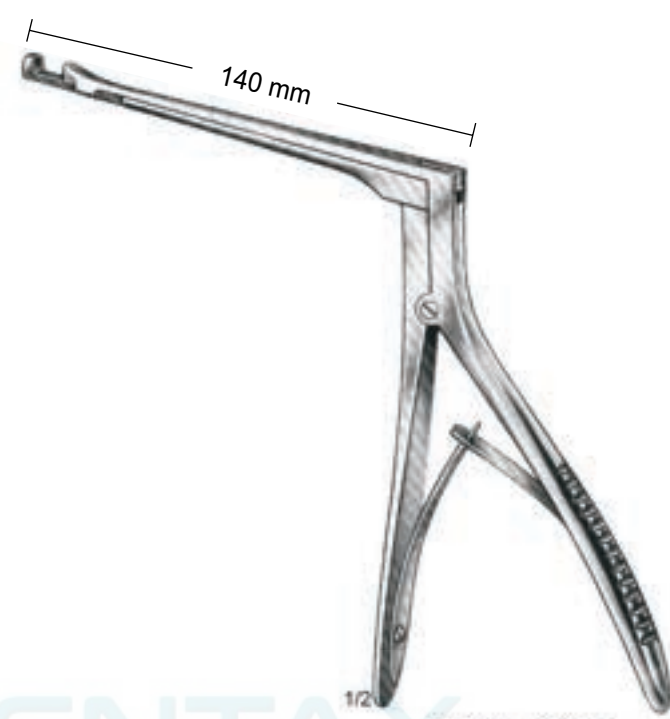
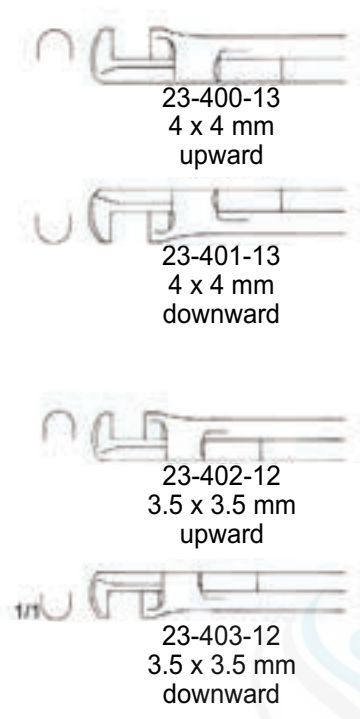
**Myles**  
 23-329-01 - 23-329-04  
 19 cm



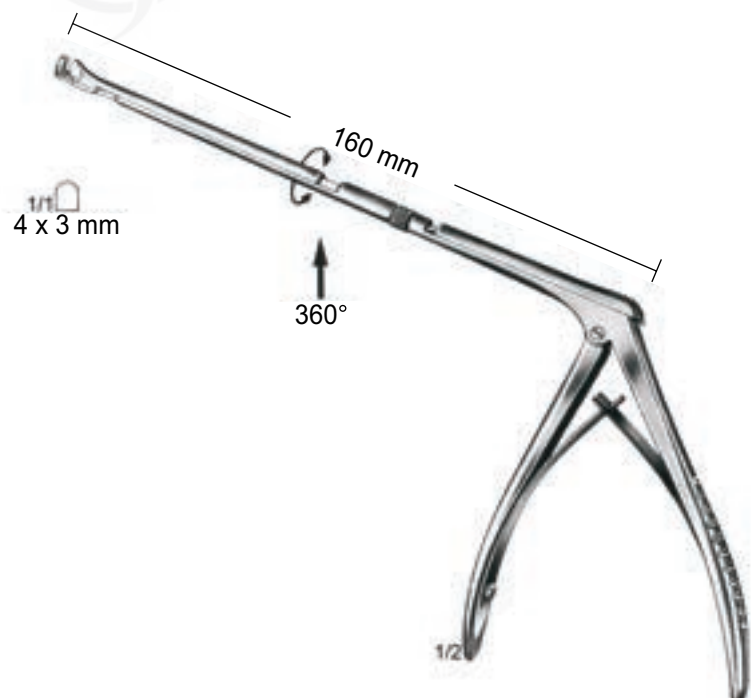








Hajek - Koffler  
 23-400-13 - 23-403-12



Hajek - Koffler  
 23-406-16

180 mm



23-420-03  
 3 mm  
 upward



23-420-05  
 5 mm  
 upward

Ferris - Smith - Kerrison (Cloward Harper)  
 23-420-03 - 23-420-05



23-426-17  
 3 x 3 mm  
 upward



23-427-17  
 3 x 3 mm  
 downward



23-430-17  
 5 x 5 mm  
 upward




23-431-17  
 5 x 5 mm  
 downward


180 mm




Ferris - Smith - Kerrison  
 23-426-17 - 23-431-17




23-441-03  
 3 x 3 mm



23-441-04  
 4 x 4 mm



23-441-05  
 5 x 5 mm



1/1  
 23-441-06  
 6 x 6 mm

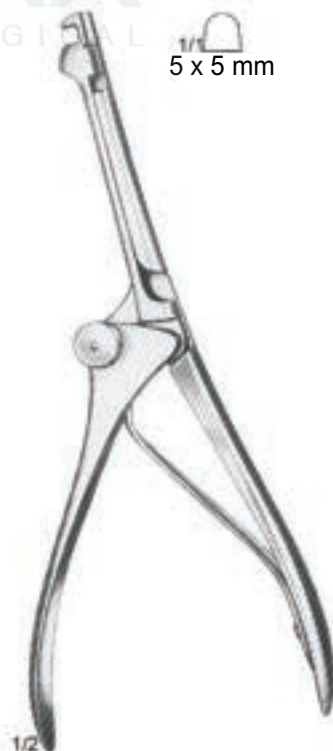
upward



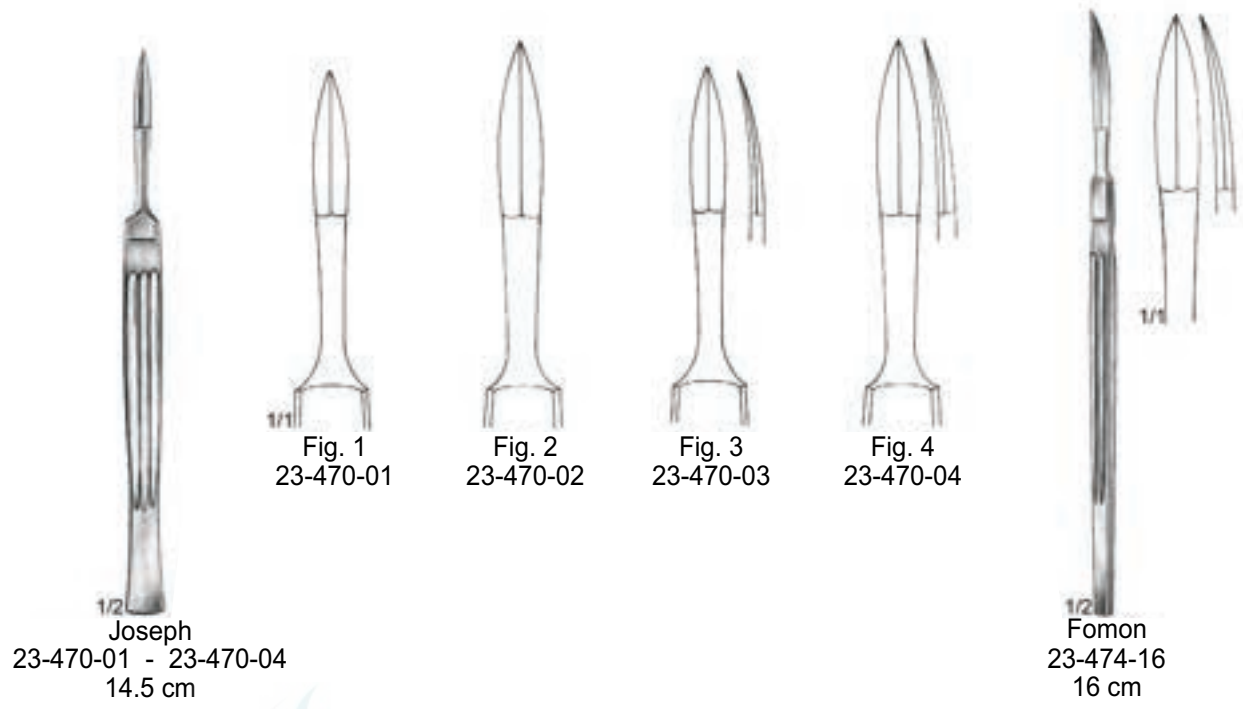
1/1  
 5 x 5 mm



Kerrison  
 23-441-03 - 23-441-06  
 20 cm



Hajek - Claus  
 23-447-20  
 20 cm





Ballenger  
23-514-03 - 23-514-05  
20 cm



Ballenger  
23-515-03 - 23-515-05  
20 cm



Bruenings  
23-518-16  
16.5 cm



1/2  
Freer  
23-520-15  
15 cm



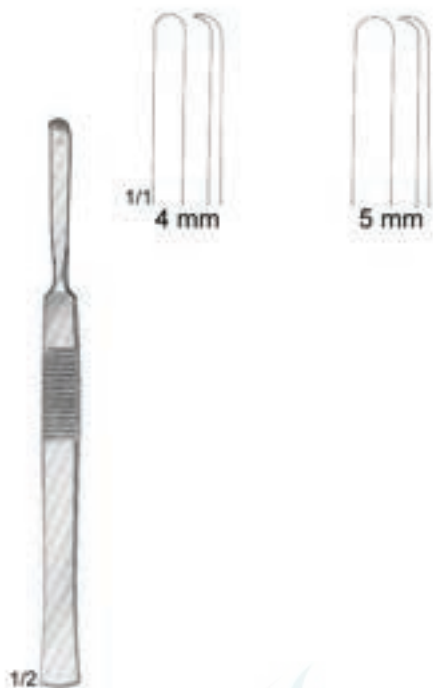
1/2  
Freer  
23-522-15  
15 cm



1/2  
Joseph  
23-526-16  
16.5 cm



1/2  
Maltz  
23-527-16  
16.5 cm



1/2  
 McKenty  
 23-541-04 - 23-541-05



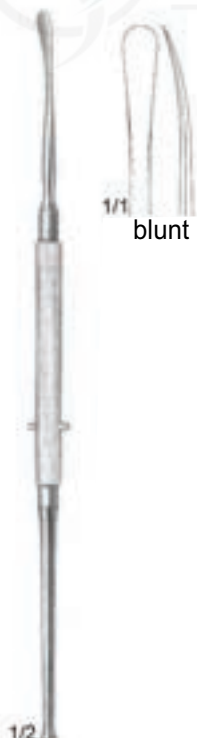
1/2  
 Halle  
 23-543-16  
 16.5 cm



1/2  
 Joseph  
 23-545-16  
 16 cm



1/2  
 Freer  
 23-551-19  
 19 cm



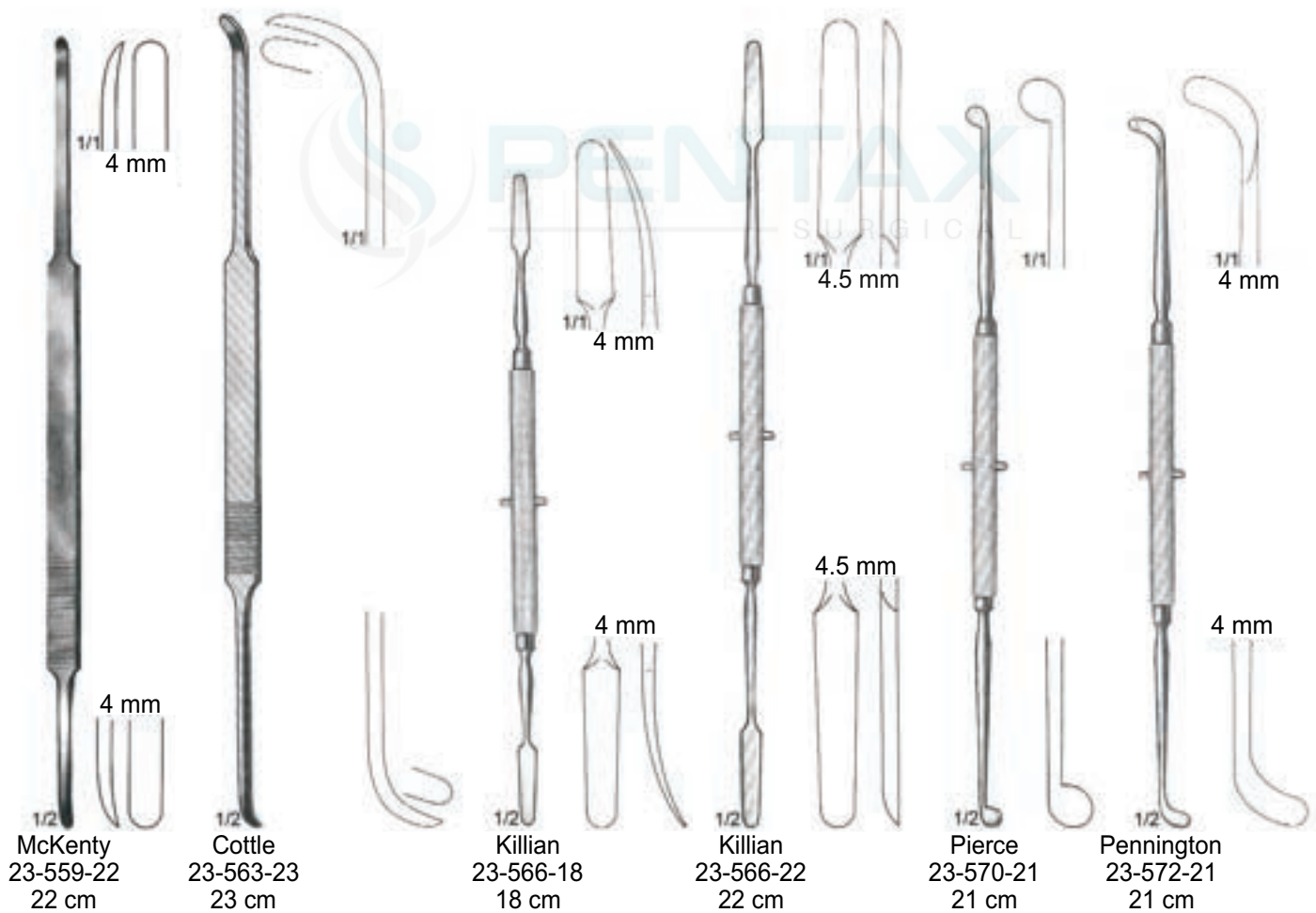
1/2  
 Freer  
 23-553-19  
 19 cm

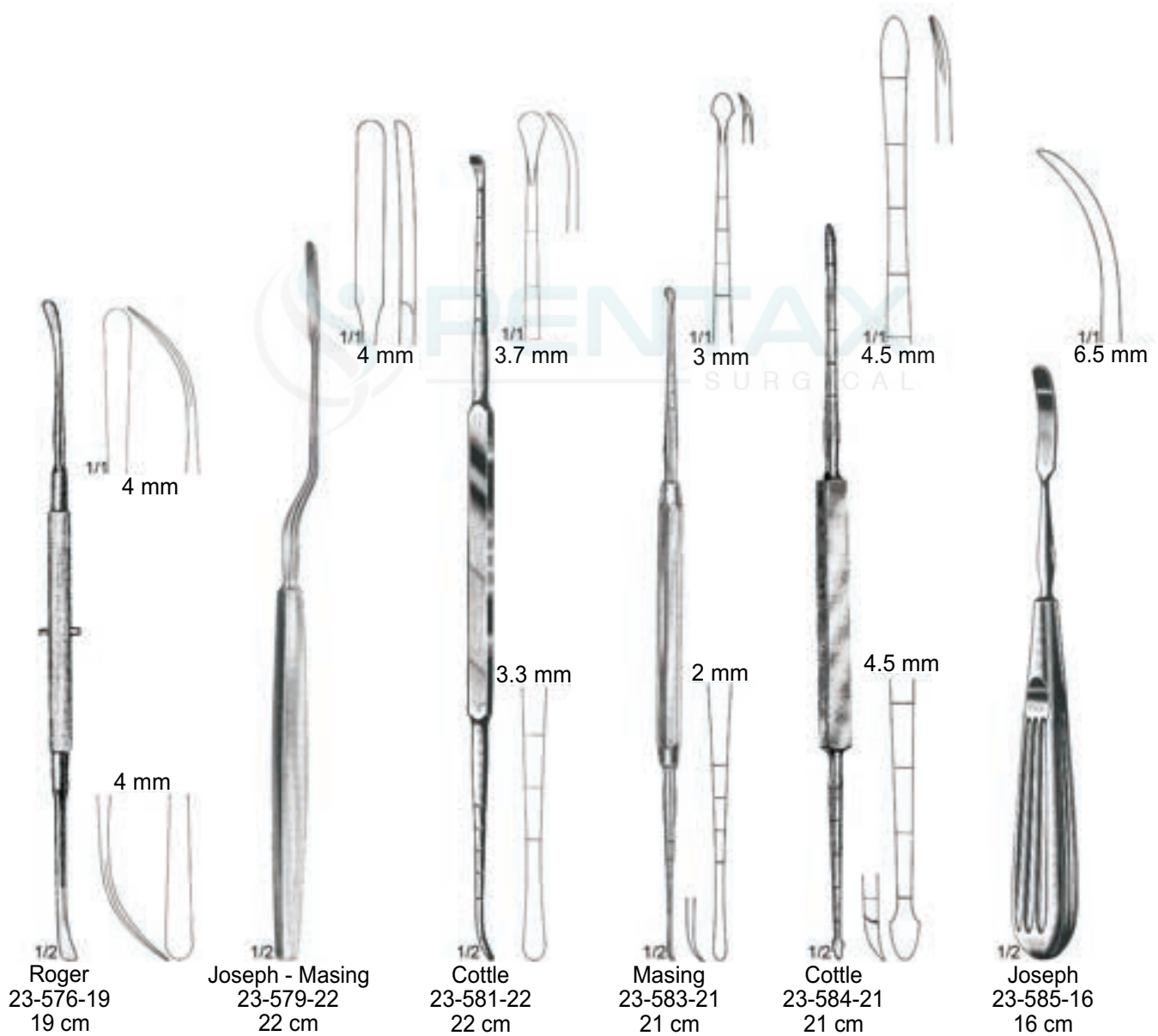


1/2  
 Freer  
 23-556-18  
 18 cm



1/2  
 Freer  
 23-557-20  
 20.5 cm







23-600-04 4 mm  
23-600-06 6 mm  
23-600-08 8 mm



1/2  
Ballenger  
23-600-04 - 23-600-08  
16 cm

4 mm

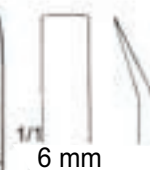
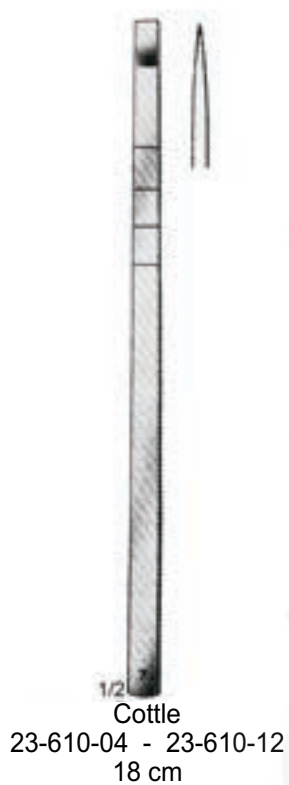


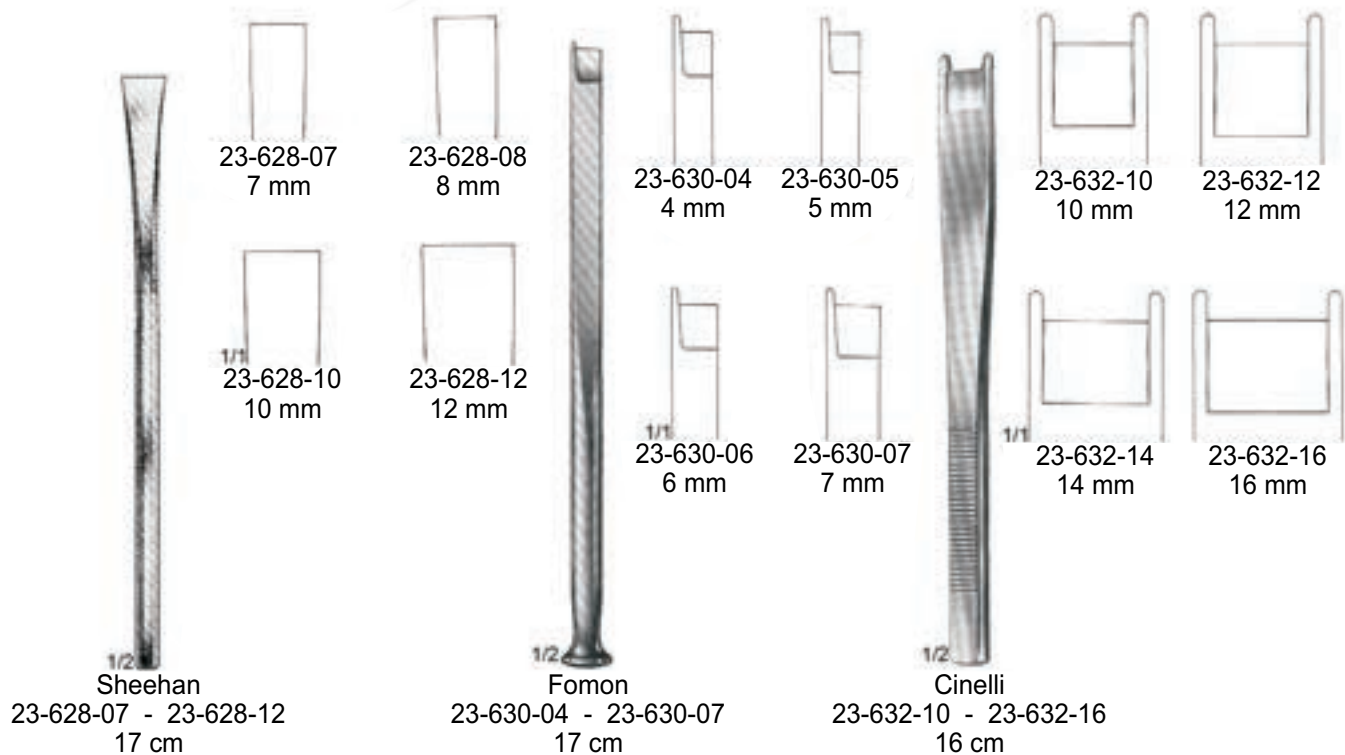
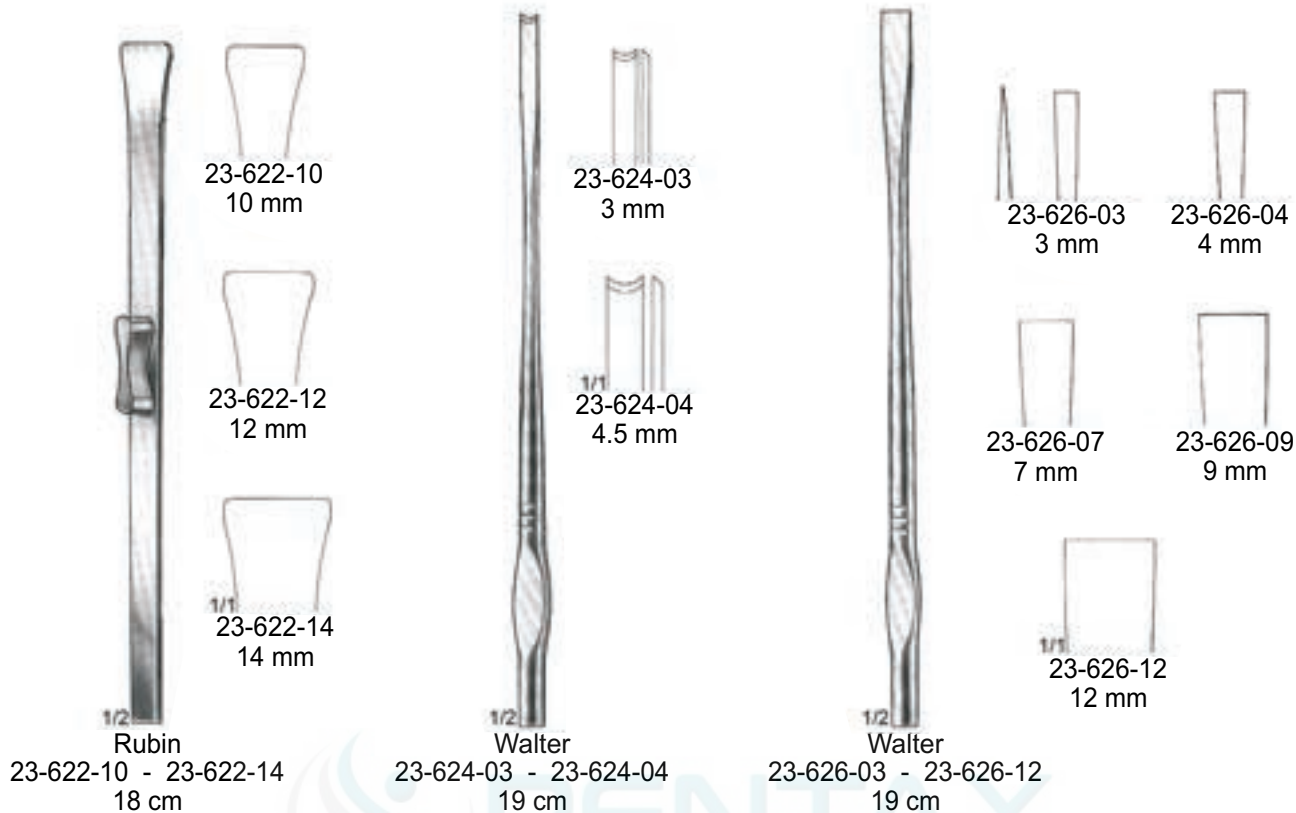
1/2  
West  
23-604-16  
16 cm

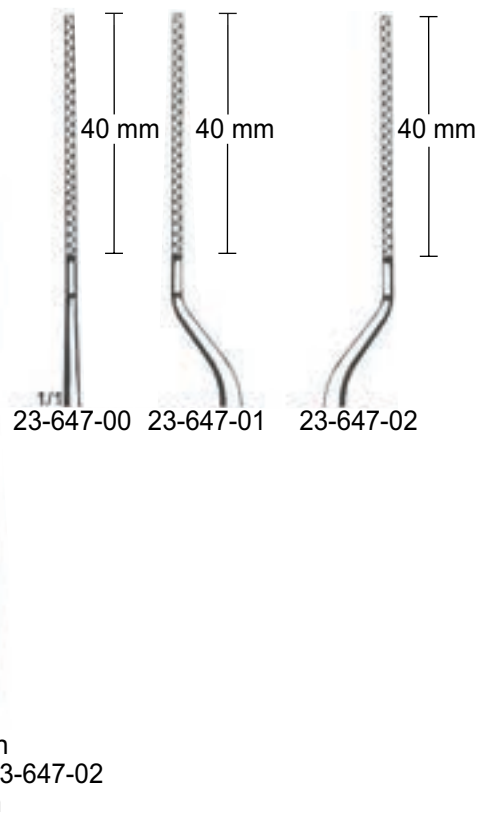
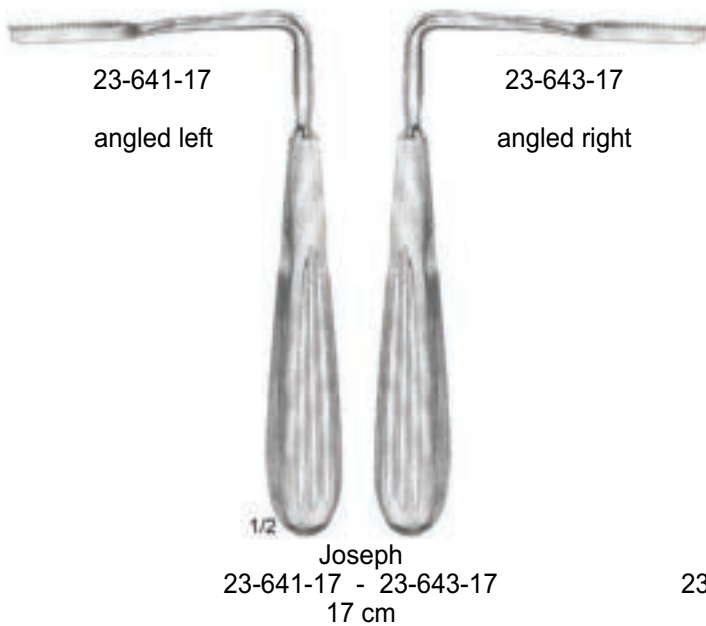
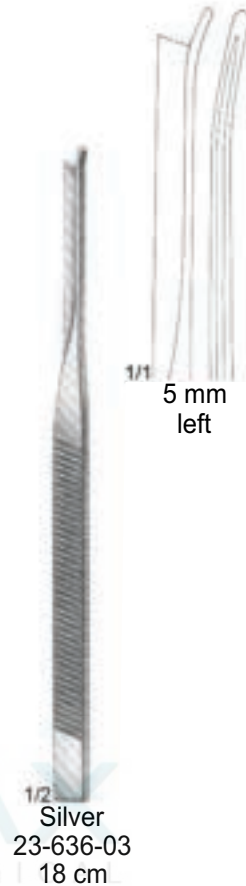
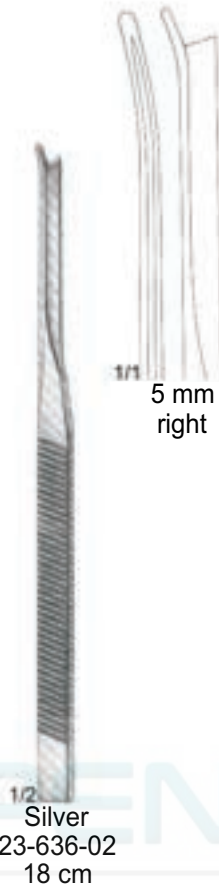
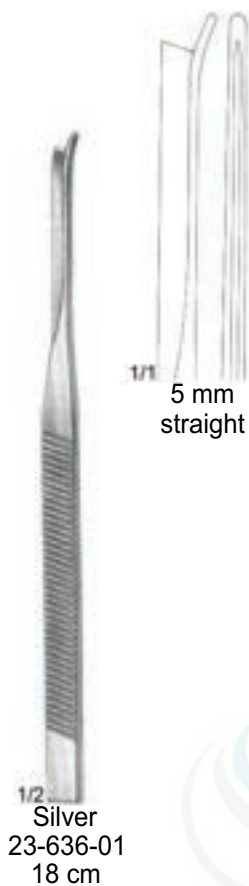
4 mm



1/2  
West  
23-608-16  
16 cm







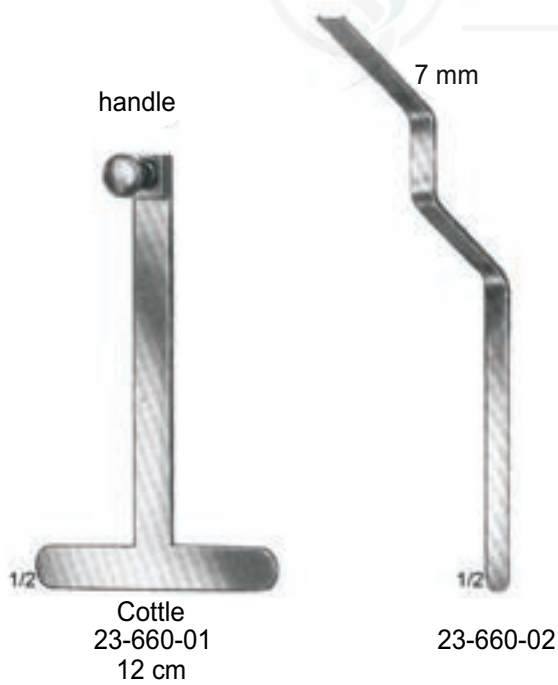
straight

right

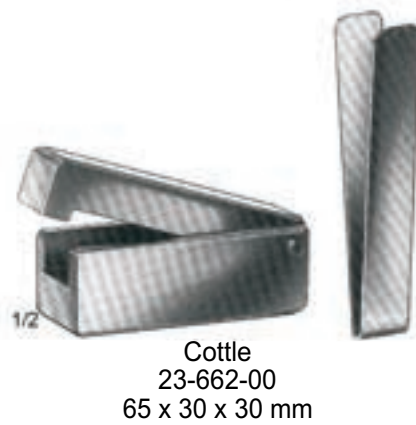
left

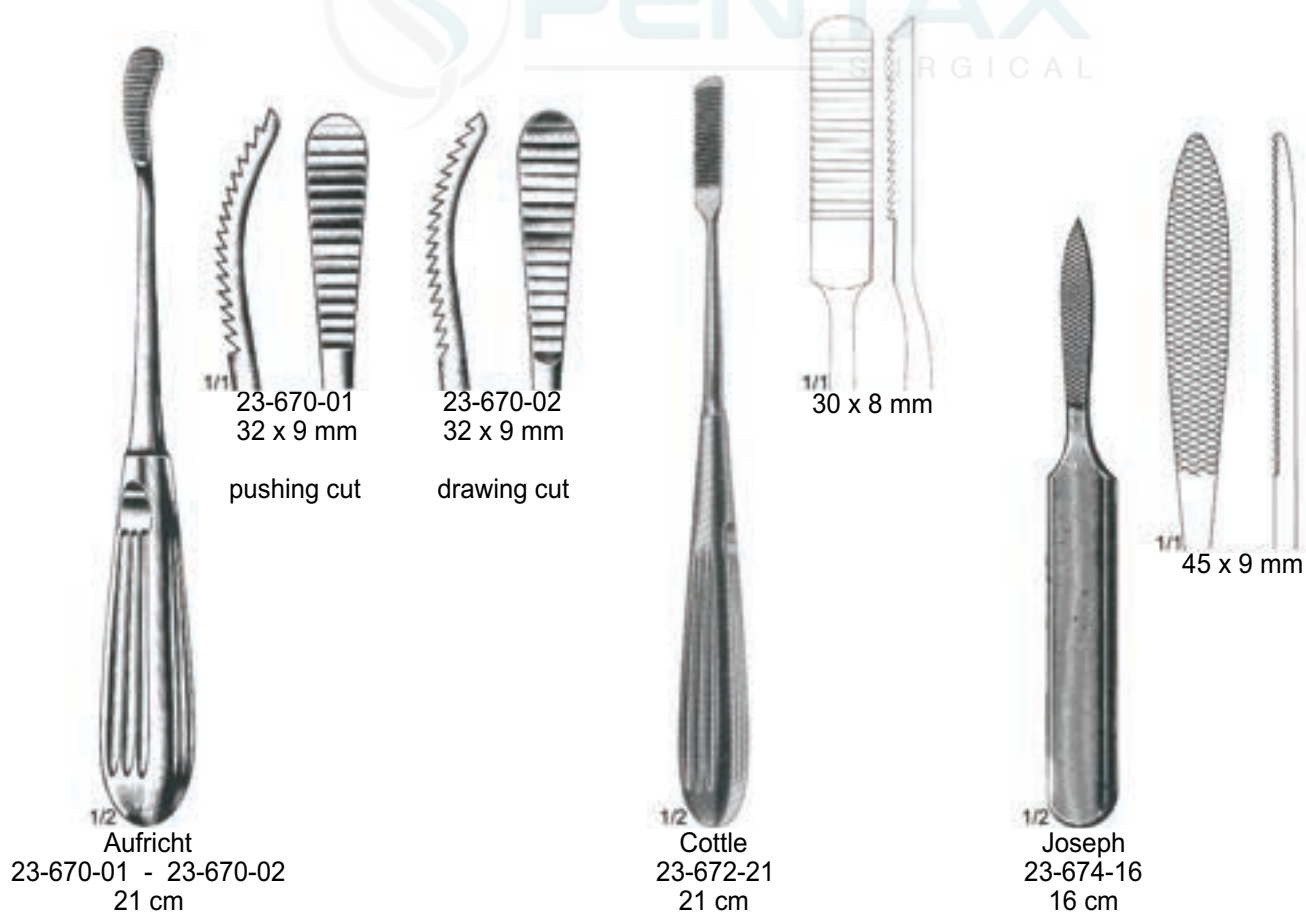
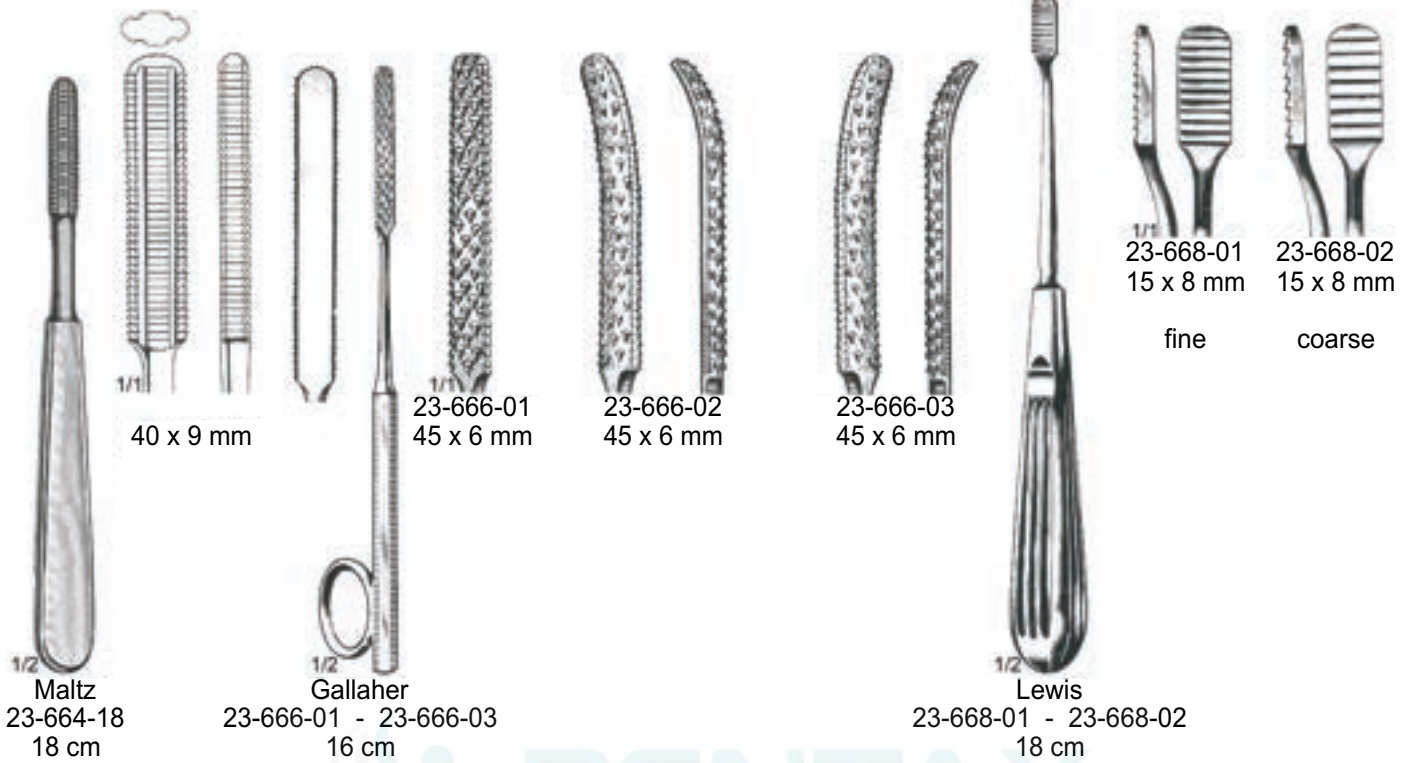


guide support for osteotomes



cartilage crusher







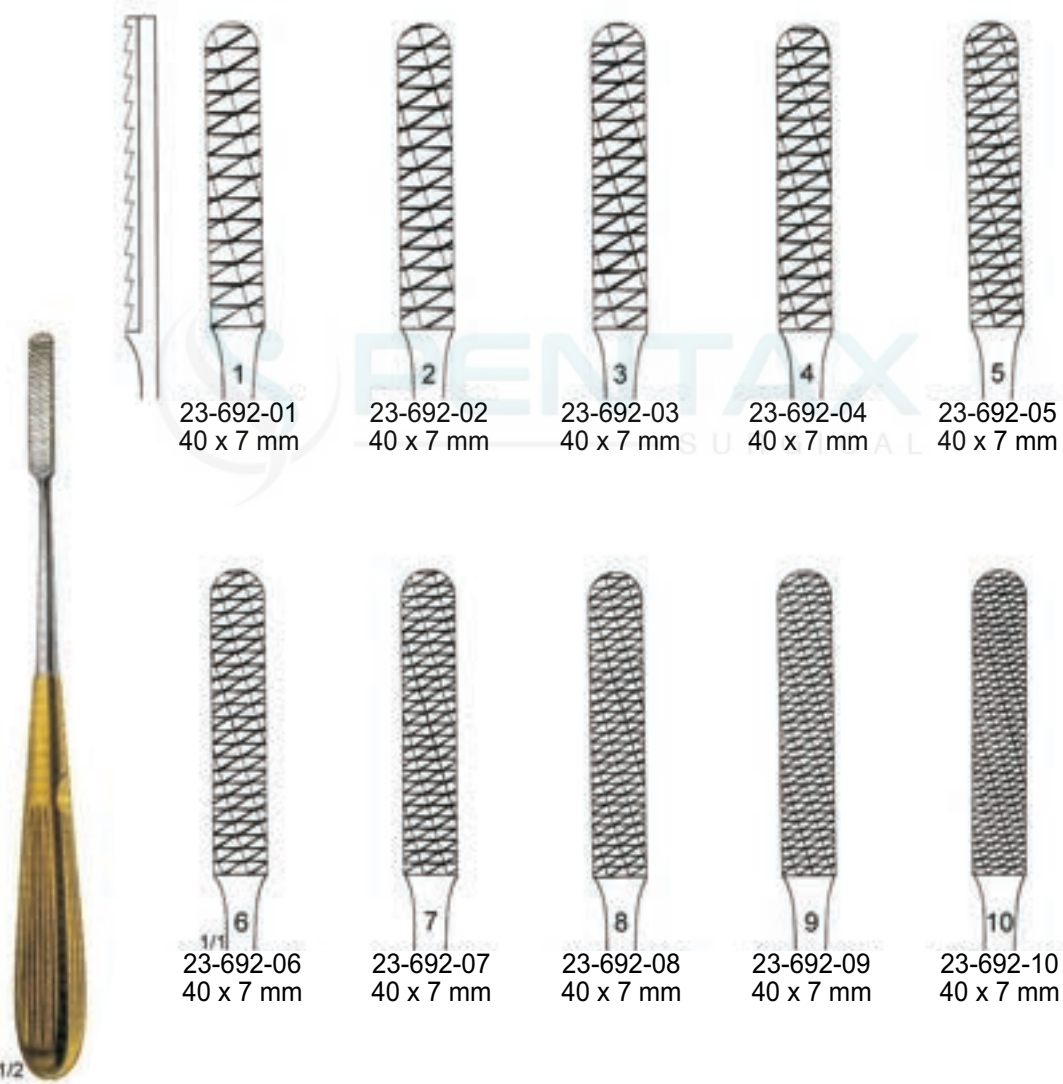




Miller - Colburn  
 23-688-01 - 23-688-05  
 19 cm



Miller - Colburn  
 23-690-01 - 23-690-05  
 19 cm



23-692-01  
40 x 7 mm

23-692-02  
40 x 7 mm

23-692-03  
40 x 7 mm

23-692-04  
40 x 7 mm

23-692-05  
40 x 7 mm

23-692-06  
40 x 7 mm

23-692-07  
40 x 7 mm

23-692-08  
40 x 7 mm

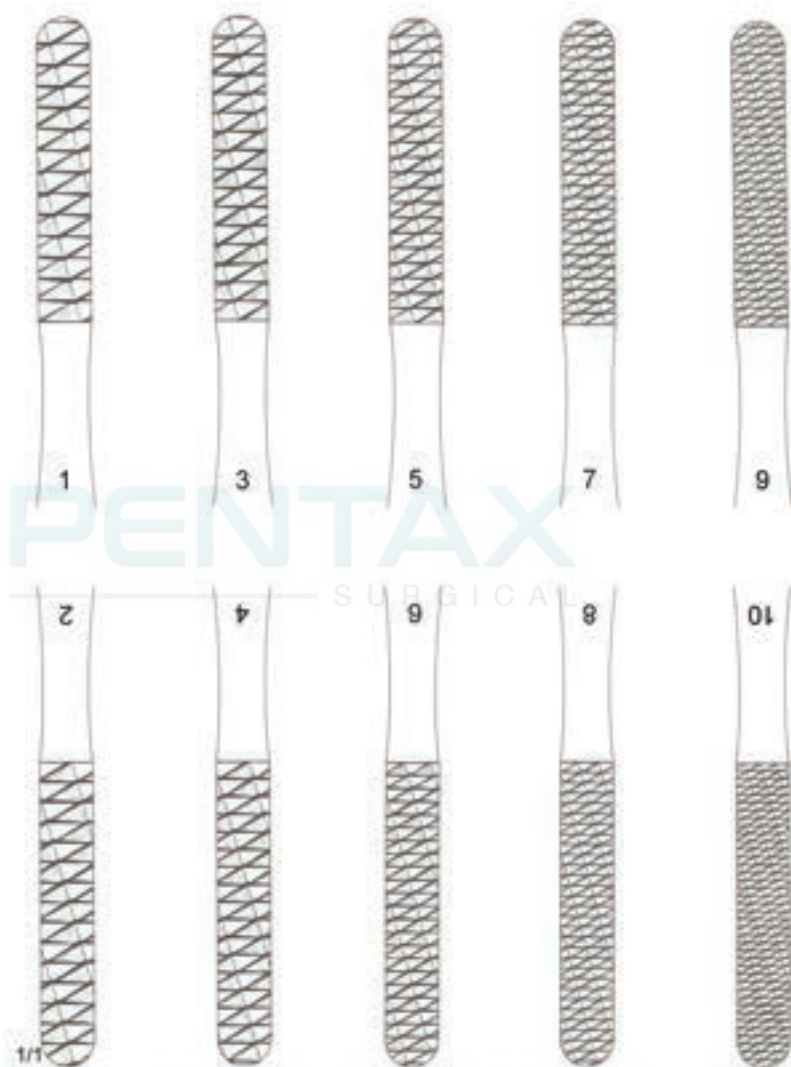
23-692-09  
40 x 7 mm

23-692-10  
40 x 7 mm

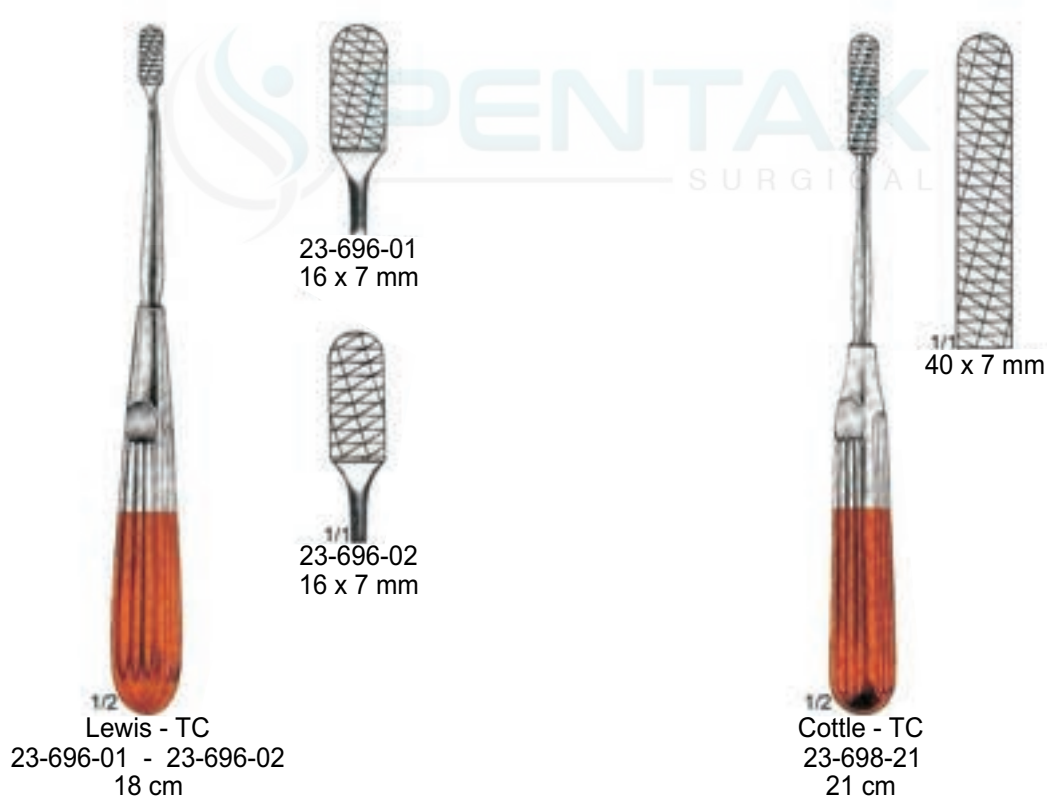
1/2  
Maltz - TC  
23-692-01 - 23-692-10  
19.5 cm

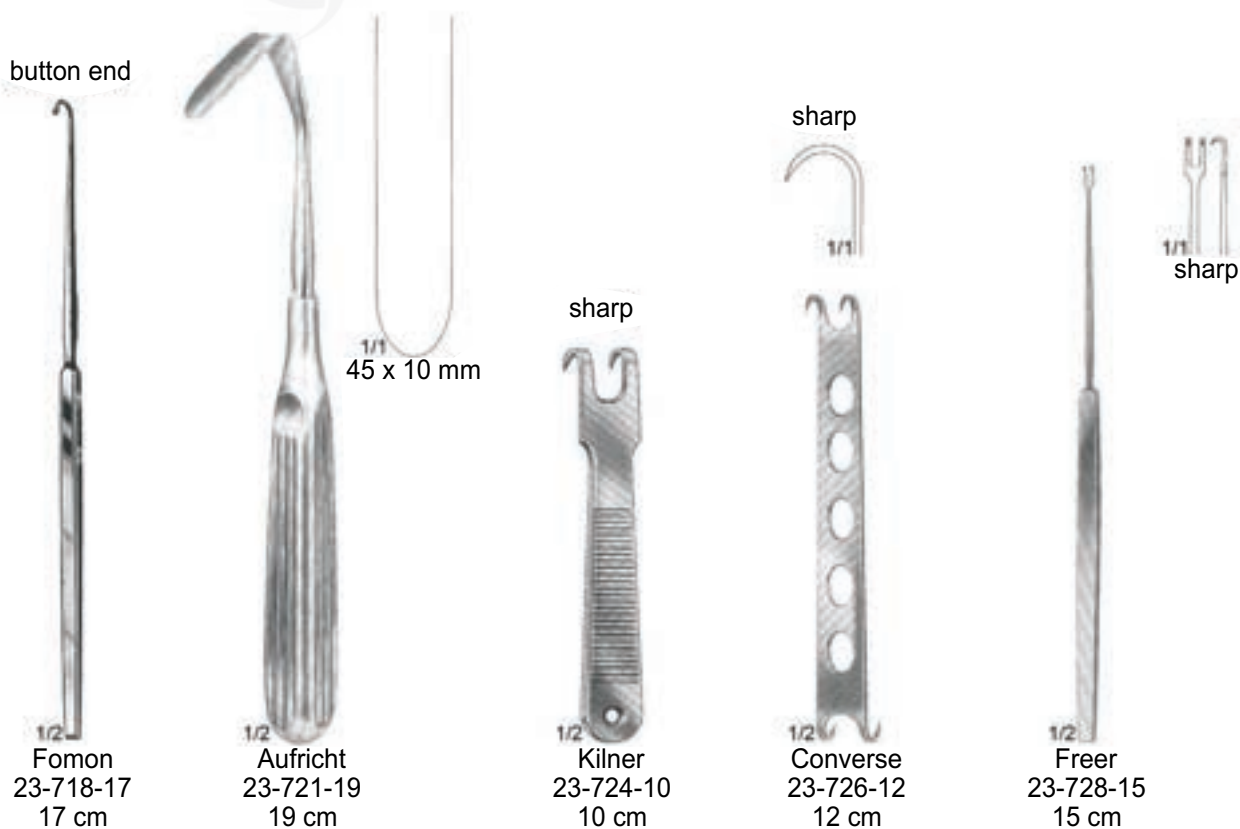
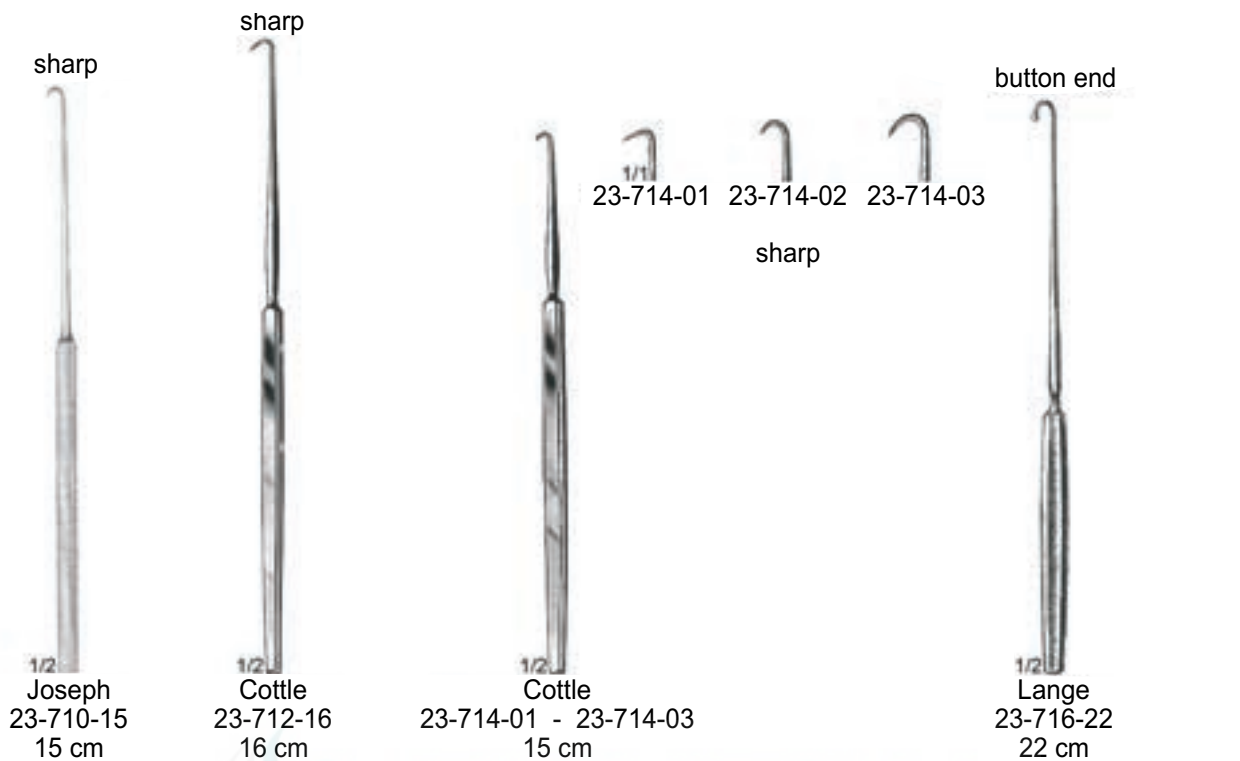


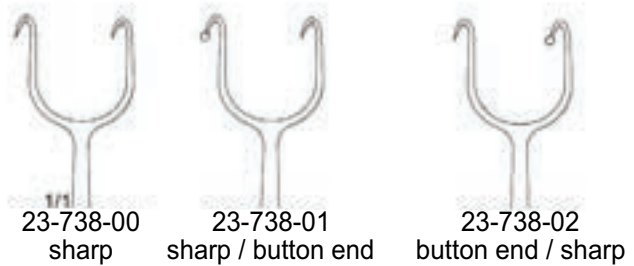
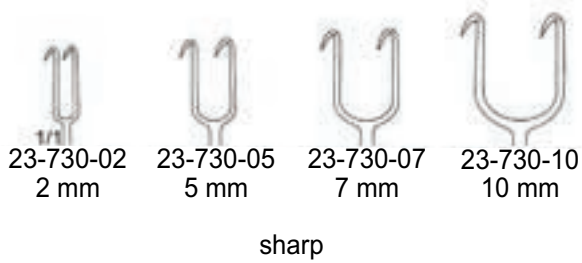
Fomon - TC  
 23-694-01 - 23-694-05  
 20 cm



|                        |                        |                        |                        |                        |
|------------------------|------------------------|------------------------|------------------------|------------------------|
| 23-694-01<br>40 x 7 mm | 23-694-02<br>40 x 7 mm | 23-694-03<br>40 x 7 mm | 23-694-04<br>40 x 7 mm | 23-694-05<br>40 x 7 mm |
|------------------------|------------------------|------------------------|------------------------|------------------------|









1/2  
 Cottle  
 23-740-14  
 14 cm



1/2  
 Neivert  
 23-742-16  
 16 cm



1/2  
 Cottle  
 23-744-15  
 15 cm



1/2  
 Cottle  
 23-746-15  
 15 cm

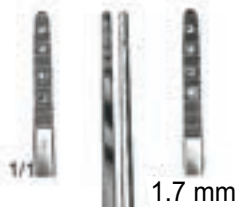
60 x 6.5 mm



blunt  
 1/2  
 Aufricht  
 23-749-13  
 13.5 cm



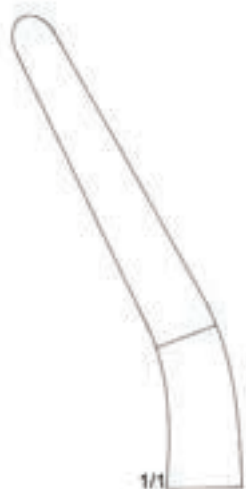
1/2  
Ogura  
23-770-11



1/2  
Cottle  
23-775-14



1/2  
Cottle (Columella)  
23-778-10



1/1



23-806-01  
straight



23-806-02  
left



23-806-03  
right



1/2

Asch  
23-801-23  
23 cm



1/2

Walsham  
23-806-01 - 23-806-03  
23 cm



1/2

Cottle - Walsham  
23-810-22  
22 cm



Faulkner  
 23-830-21  
 21 cm



Coakley  
 23-841-01 - 23-841-06  
 17 cm

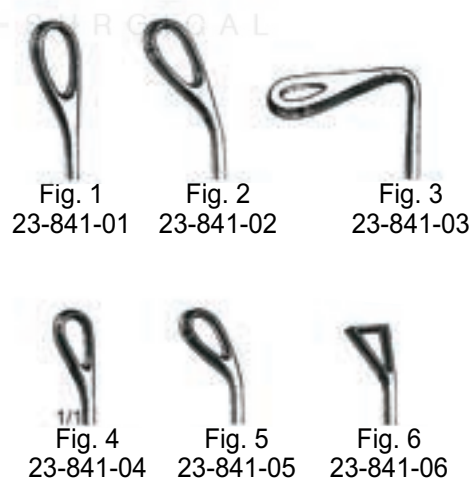


Fig. 1 23-841-01  
 Fig. 2 23-841-02  
 Fig. 3 23-841-03  
 Fig. 4 23-841-04  
 Fig. 5 23-841-05  
 Fig. 6 23-841-06



Fig. 1  
 23-860-01  
 23-861-01  
 13 mm



Fig. 2  
 23-860-02  
 23-861-02  
 15 mm



Fig. 3  
 23-860-03  
 23-861-03  
 17 mm



Fig. 4  
 23-860-04  
 23-861-04  
 21 mm



Fig. 5  
 23-860-05  
 23-861-05  
 23 mm



Fig. 6  
 23-860-06  
 23-861-06  
 23 mm



Beckmann  
 23-860-01 - 23-860-06  
 22 cm



Beckmann  
 23-861-01 - 23-861-06  
 22 cm



23-866-01  
13 mm



23-866-02  
15 mm



23-866-03  
17 mm



23-866-04  
19 mm



Barnhill  
23-866-01 - 23-866-04  
22 cm



23-870-01  
17 mm



23-870-02  
19 mm



23-870-03  
21 mm



23-870-04  
22 mm



St. Clair - Thompson  
23-870-01 - 23-870-04  
21 cm

with unperforated blade



Fig. 1  
23-880-01



Fig. 2  
23-880-02



Fig. 3  
23-880-03

with perforated blade



Fig. 1  
23-882-01



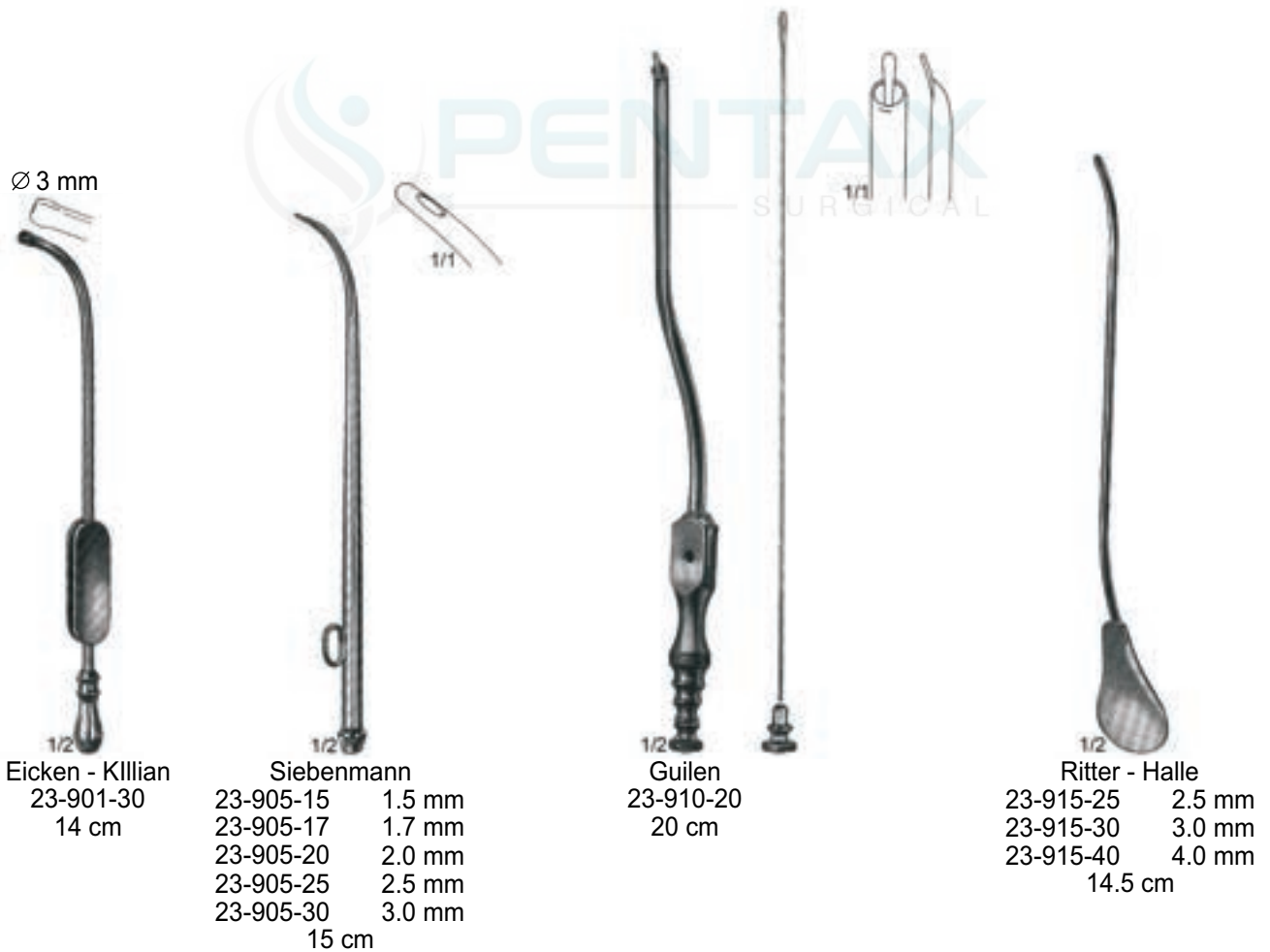
Fig. 2  
23-882-02

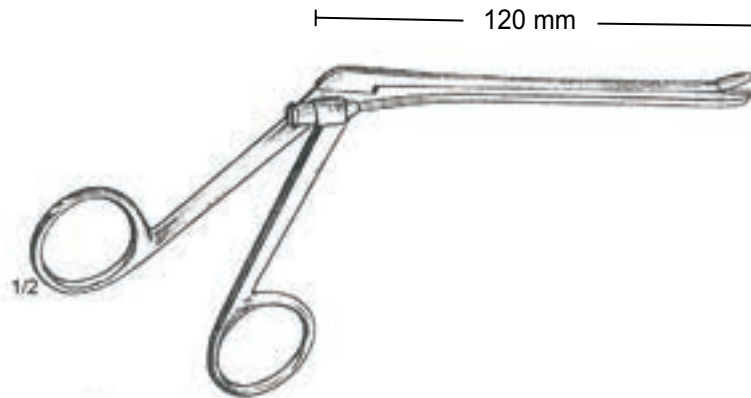


Fig. 3  
23-882-03






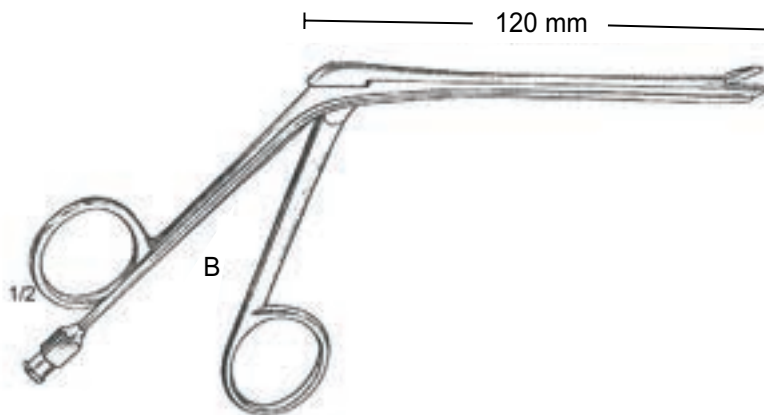
1/2  
La Force  
23-880-01 - 23-882-03  
25 cm



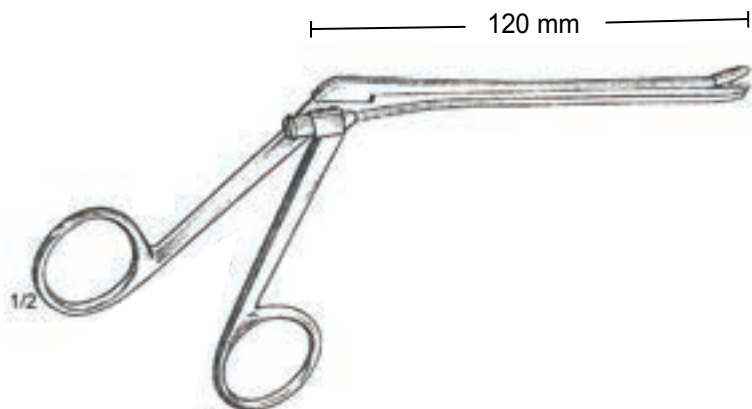


Weil - Blakesley  
23-930-01 - 23-930-23




|     |   |  |  |  |
|-----|---|---|---|---|
| 0°  | A | 23-930-01   | 23-930-02   | 23-930-03   |
|     | B | 23-930-11   | 23-930-12   | 23-930-13   |
| 45° | A | 23-930-06   | 23-930-07   | 23-930-08   |
|     | B | 23-930-16   | 23-930-17   | 23-930-18   |
| 90° | A | 23-930-21   | 23-930-22   | 23-930-23   |
|     | B | 23-930-31   | 23-930-32   | 23-930-33   |
|     |   | 2.5 mm  | 3.0 mm  | 3.5 mm  |

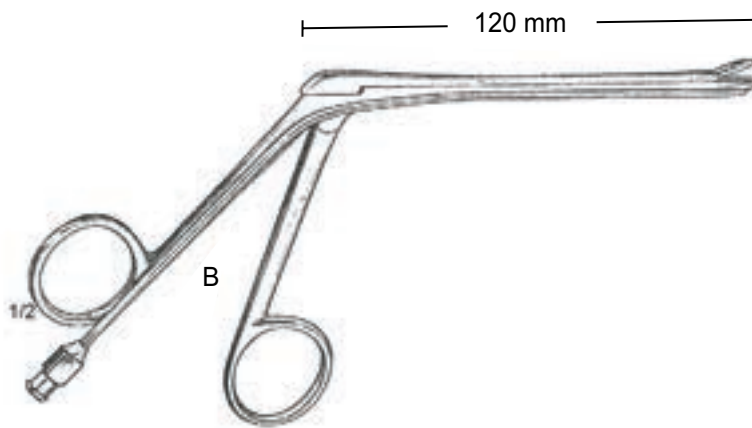


Weil - Blakesley  
23-930-11 - 23-930-33



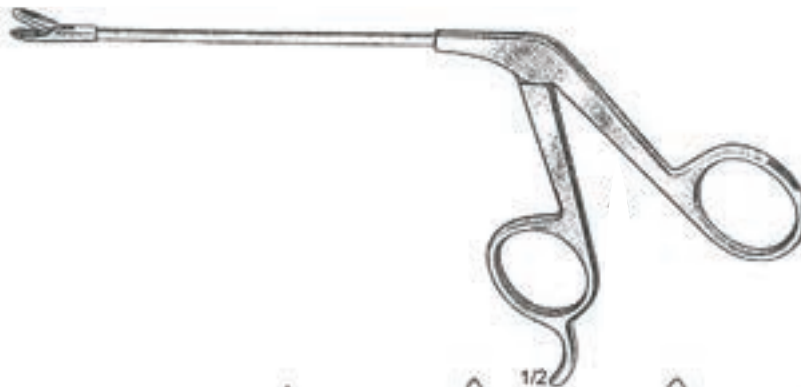
Weil - Blakesley  
23-930-40 - 23-930-47

|       |   |  |  |  |
|-------|---|---|---|---|
| right | A | 23-930-40   | 23-930-41   | 23-930-42   |
|       | B | 23-930-50   | 23-930-51   | 23-930-52   |
| left  | A | 23-930-45   | 23-930-46   | 23-930-47   |
|       | B | 23-930-55   | 23-930-56   | 23-930-57   |
|       |   | 2.5 mm  | 3.0 mm  | 3.5 mm  |



Weil - Blakesley  
23-930-50 - 23-930-57

120 mm - Ø 3.5 mm



|                  |    |   |           |           |           |           |
|------------------|----|---|-----------|-----------|-----------|-----------|
| Weil - Blakesley | 0° | A | 23-940-01 | 23-940-02 | 23-940-03 | 23-940-04 |
|                  |    | B | 23-940-11 | 23-940-12 | 23-940-13 | 23-940-14 |
|                  |    |   | 2.5 mm    | 3.0 mm    | 3.5 mm    | 4.0 mm    |

|                  |     |   |           |           |           |           |
|------------------|-----|---|-----------|-----------|-----------|-----------|
| Weil - Blakesley | 45° | A | 23-940-06 | 23-940-07 | 23-940-08 | 23-940-09 |
|                  |     | B | 23-940-16 | 23-940-17 | 23-940-18 | 23-940-19 |
|                  |     |   | 2.5 mm    | 3.0 mm    | 3.5 mm    | 4.0 mm    |

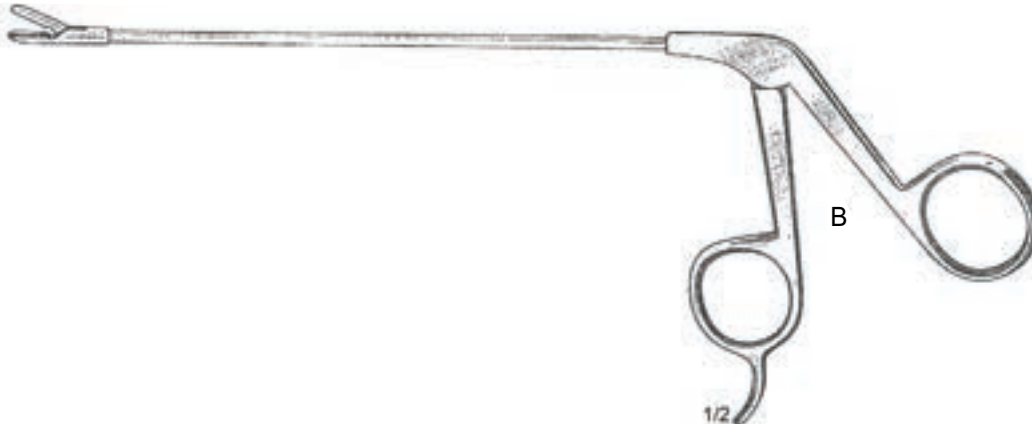


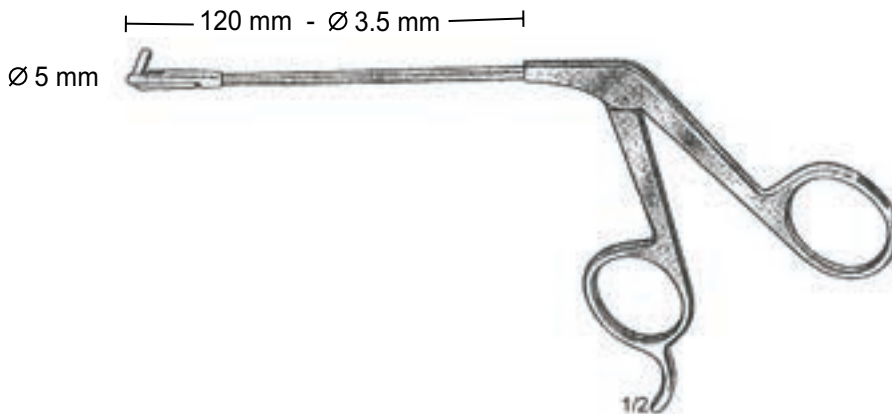
|           |   |           |
|-----------|---|-----------|
| Takahashi | A | 23-940-27 |
|           | B | 23-940-37 |
|           |   | 4 x 10 mm |






|           |   |           |
|-----------|---|-----------|
| Struycken | A | 23-940-28 |
|           | B | 23-940-38 |
|           |   | 1 x 10 mm |

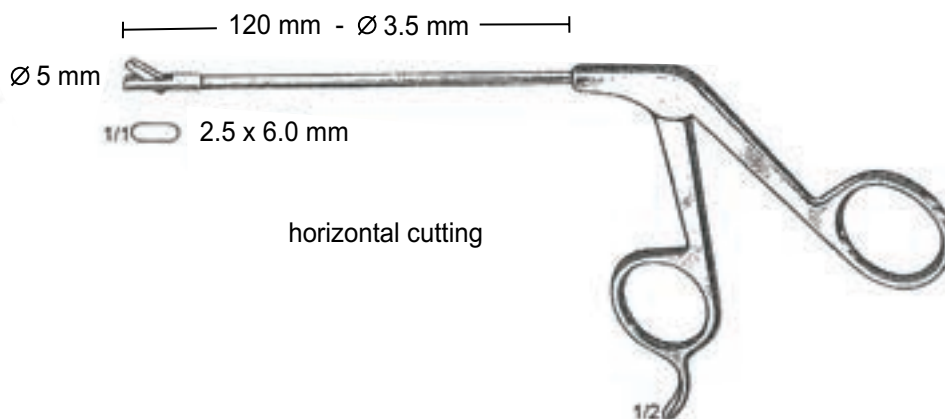
170 mm - Ø 3.5 mm





Stanzen Punches  
 23-950-01 - 23-950-23

|   |              |              |              |
|---|--------------|--------------|--------------|
|    | 23-950-01    | 23-950-02    | 23-950-03    |
|    | 23-950-11    | 23-950-12    | 23-950-13    |
|  | 23-950-21    | 23-950-22    | 23-950-23    |
|   | 1.5 x 6.0 mm | 2.0 x 6.0 mm | 2.5 x 8.0 mm |



|           |     |
|-----------|-----|
| 23-956-01 | 0°  |
| 23-956-02 | 30° |
| 23-956-03 | 45° |
| 23-956-04 | 60° |
| 23-956-05 | 70° |



23-960-01

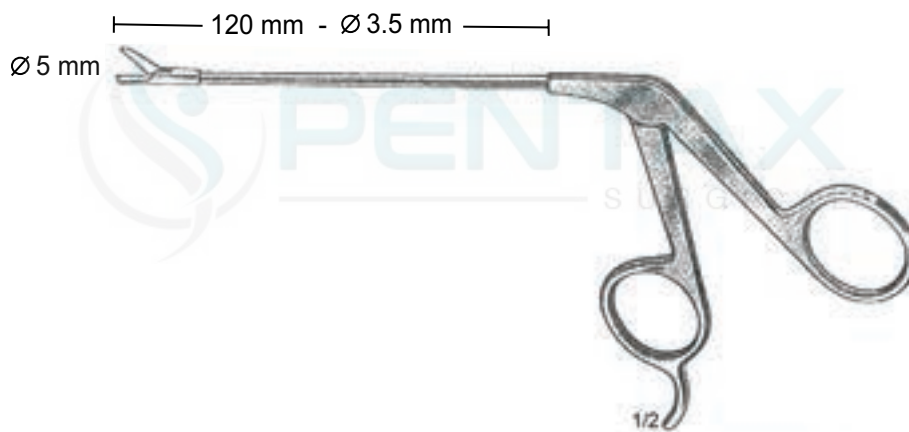


23-960-02



23-960-03

smooth



Standard  
23-960-01 - 23-960-13



23-960-11



23-960-12



23-960-13

serrated



23-960-21

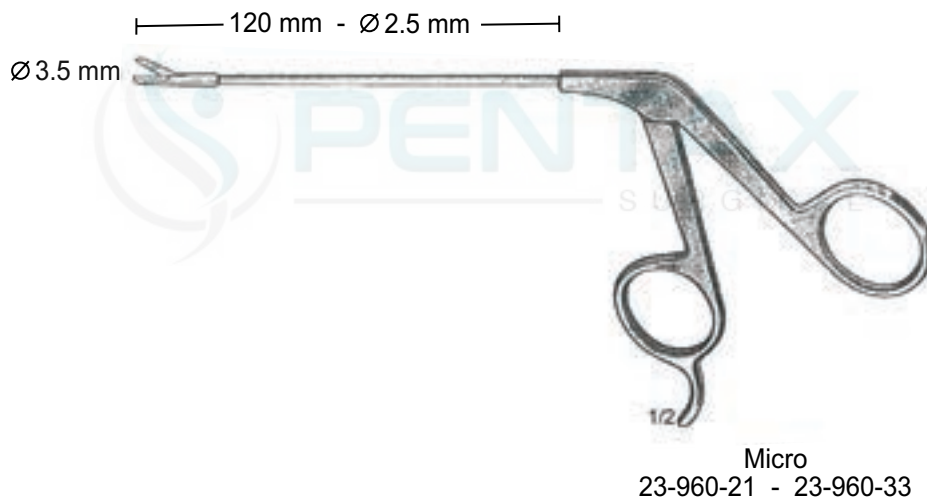


23-960-22



23-960-23

smooth



23-960-31



23-960-32



23-960-33

serrated



Stammberger  
23-970-01 - 23-970-13

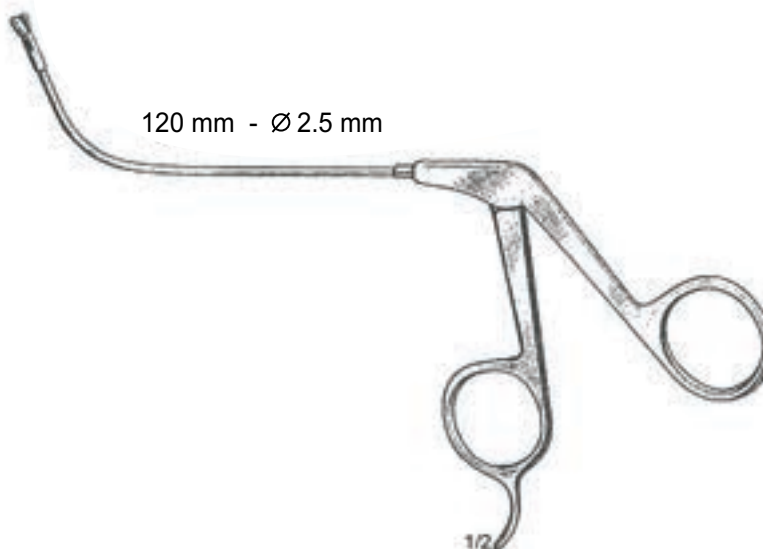
horizontal cutting

vertical cutting

70°  
90°  
110°

23-970-01  
23-970-02  
23-970-03

23-970-11  
23-970-12  
23-970-13



Stammberger  
23-976-01 - 23-976-02

horizontal cutting

vertical cutting

65°

23-976-01

23-976-02



24



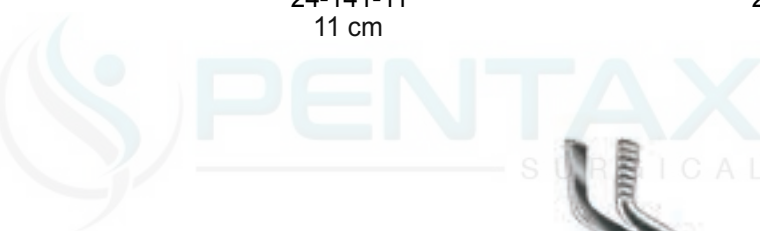
Heister  
24-100-13  
13 cm



Molt  
24-141-11  
11 cm



Molt  
24-141-14  
14 cm



Denhart  
24-147-12  
12 cm



Roser - König  
24-149-16 16 cm  
24-149-20 20 cm



24-174-10

Gag only

1/2  
Kilner - Doughty  
24-174-00

complete



1/2  
Fig. 1  
24-174-01  
65 x 28 mm



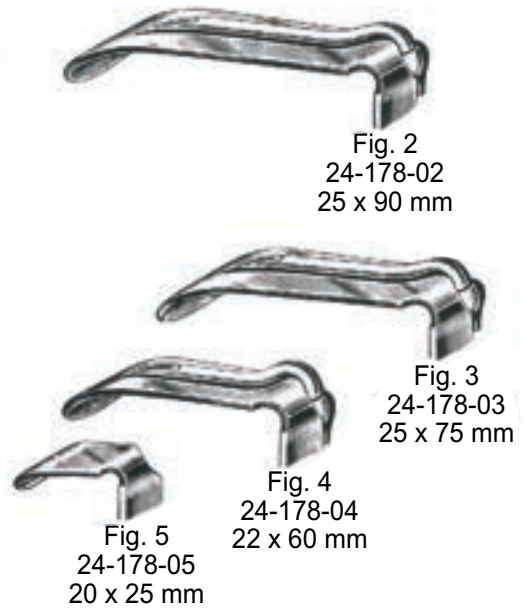
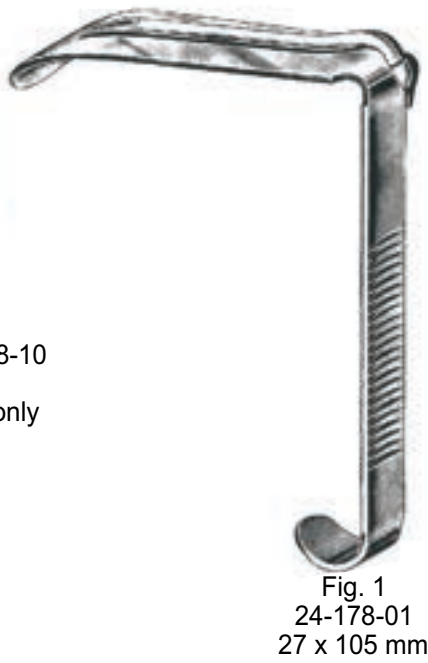
Fig. 2  
24-174-02  
75 x 32 mm



Fig. 3  
24-174-03  
80 x 37 mm



24-174-04



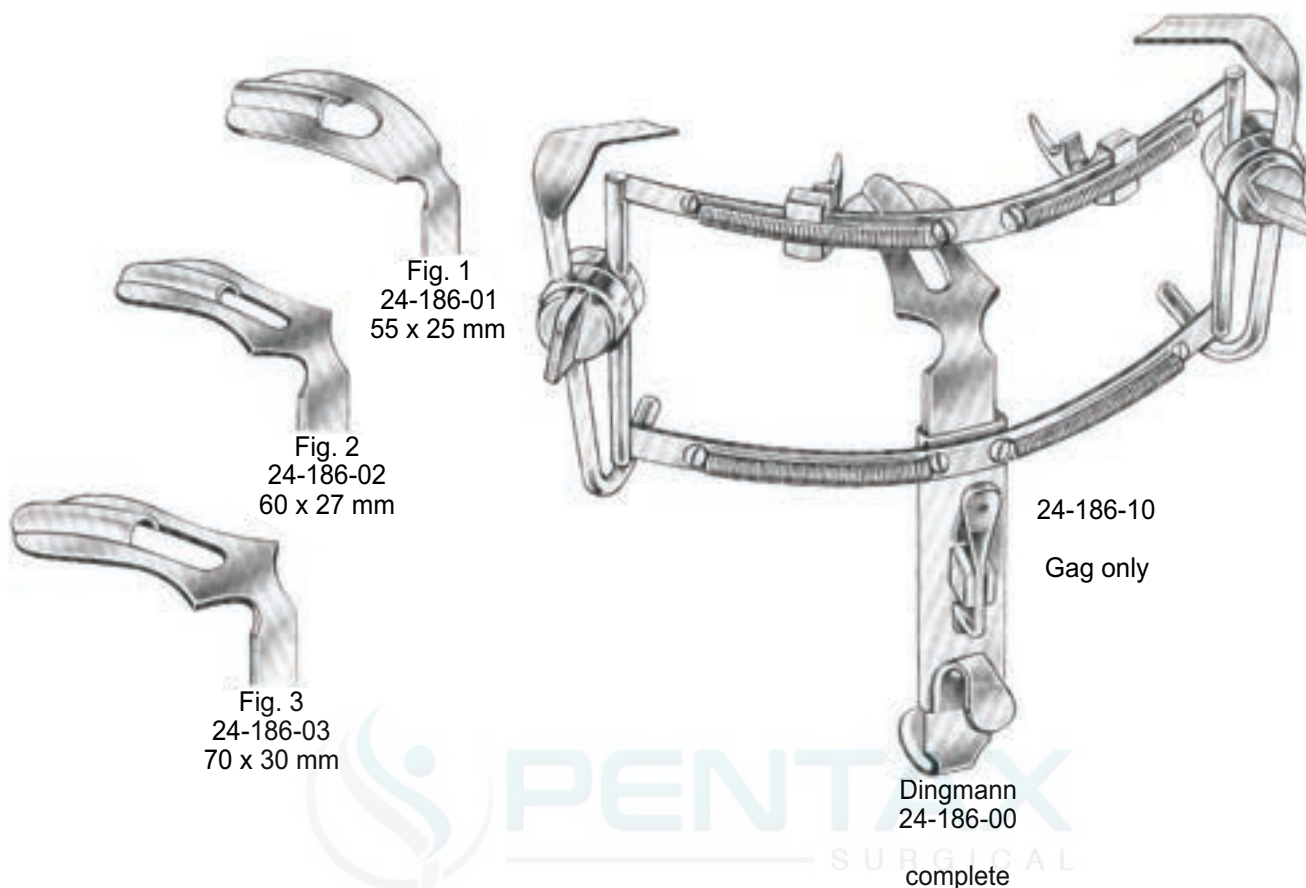


Fig. 1  
24-186-01  
55 x 25 mm

Fig. 2  
24-186-02  
60 x 27 mm

Fig. 3  
24-186-03  
70 x 30 mm

24-186-10  
Gag only

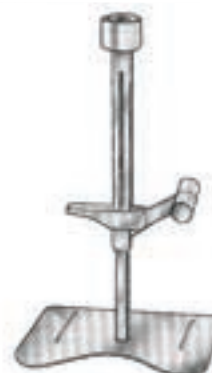
Dingmann  
24-186-00  
complete



Modell Wurzburg

- |           |        |             |
|-----------|--------|-------------|
| 24-190-01 | Fig. 1 | 66 x 28 mm  |
| 24-190-02 | Fig. 2 | 75 x 32 mm  |
| 24-190-03 | Fig. 3 | 83 x 34 mm  |
| 24-190-04 | Fig. 4 | 93 x 37 mm  |
| 24-190-05 | Fig. 5 | 100 x 38 mm |

chest support for mouth gag



Negus  
24-196-00



Jennings  
24-250-09  
24-250-11  
24-250-13  
24-250-15

9 cm  
11 cm  
13 cm  
15 cm

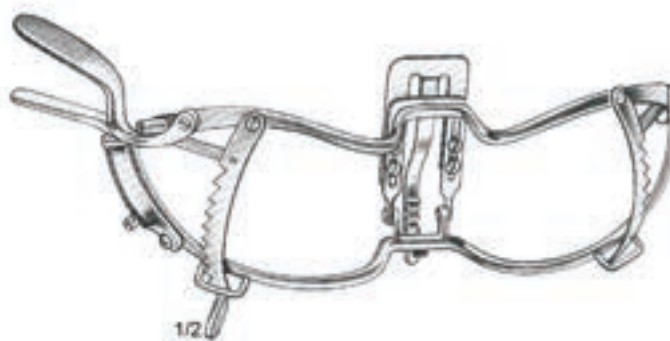


Seemann - Seiffert  
24-254-09  
24-254-11  
24-254-13  
24-254-15



Whitehead  
24-260-09  
24-260-11  
24-260-13  
24-260-15

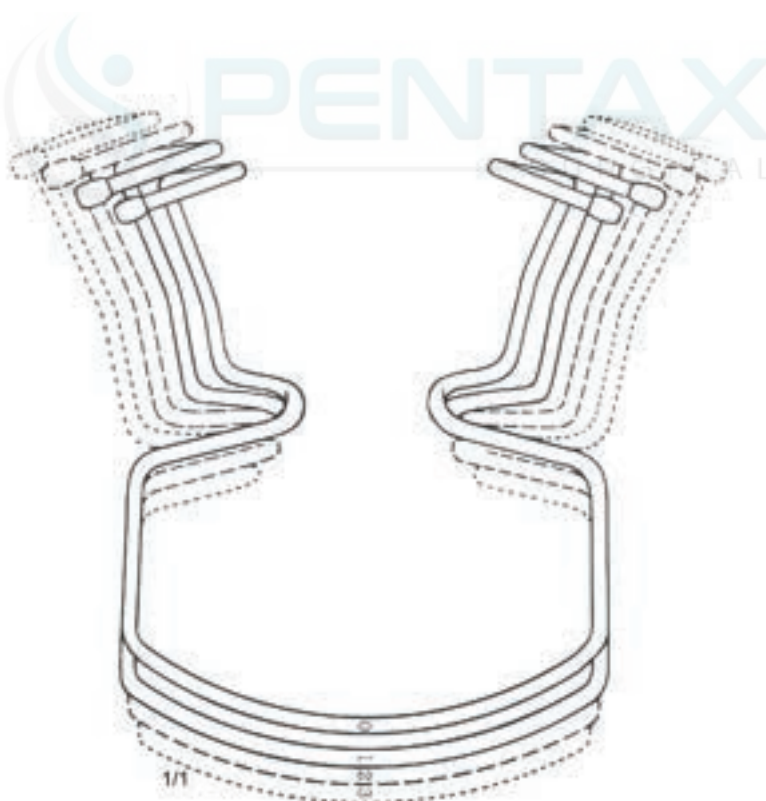
9 cm  
11 cm  
13 cm  
15 cm



Whitehead  
24-264-09  
24-264-11  
24-264-13  
24-264-15



Oringer  
 24-290-00 - 24-290-13



- 24-290-00 Fig. 0 9.5 cm
- 24-290-01 Fig. 1 10.0 cm
- 24-290-02 Fig. 2 10.5 cm
- 24-290-03 Fig. 3 11.0 cm

24-290-13 Set (Fig. 1 - 3)



1/2  
 Simplex  
 24-301-11  
 11 cm



Stemberg  
 24-305-12 12 cm  
 24-305-14 14 cm  
 24-305-16 16 cm



1/2  
 Mod. Martin  
 24-309-19  
 19 cm



1/2  
 Mod. Martin  
 24-311-21  
 21 cm



1/2  
 Bishop  
 24-315-13  
 13 cm

72 x 23 mm



1/2  
Hartmann  
24-321-15  
15 cm

88 x 25 mm



1/2  
Tobold  
24-325-14  
14.5 cm

85 x 24 mm



1/2  
Tobold  
24-329-14  
14.5 cm



1/2  
Andrew  
24-333-11  
11 cm



1/2  
Wieder  
24-337-01 - 24-337-02



1/2  
24-337-01  
14 cm



1/2  
24-337-02  
15 cm



1/2  
 Moritz - Schmidt  
 24-361-19  
 19 cm



1/2  
 Standard  
 24-365-14  
 14.5 cm



1/2  
 Univ. Minnesota  
 24-369-14



1/2  
 Kroenig  
 24-371-15  
 15 cm



1/2  
 Mayo  
 24-375-17  
 17 cm



1/2  
 23 mm  
 24-379-18  
 18 cm

Wood



24-381-16  
16 cm

Plastic



24-385-15  
15 cm



Haas  
24-389-16  
16 cm



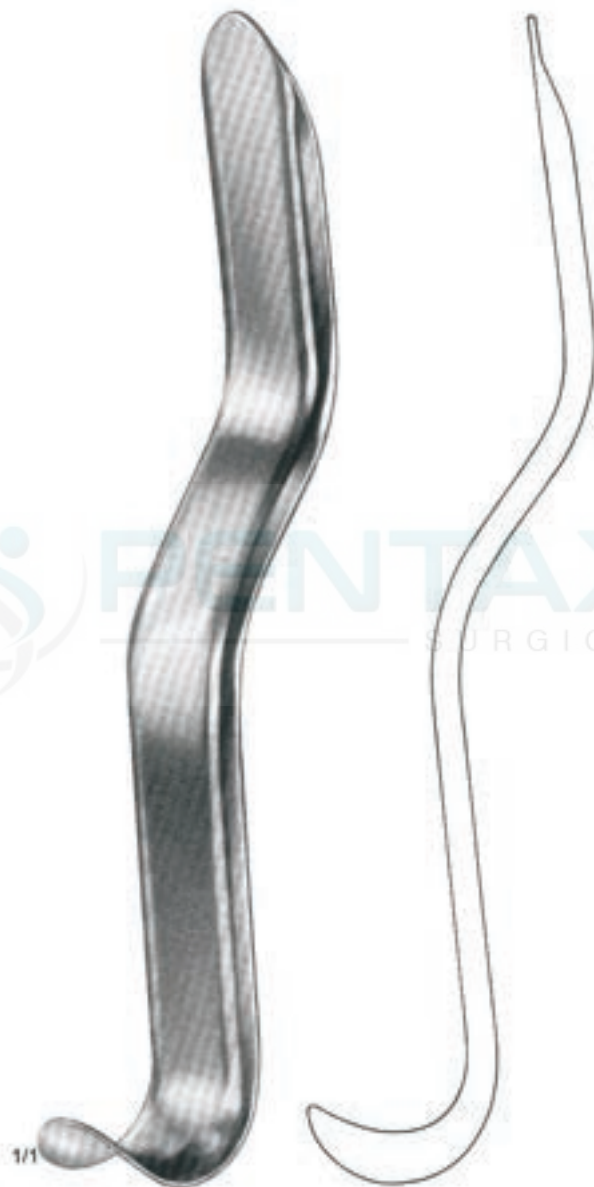
Buchwald  
24-391-17  
17 cm



15 mm  
Bruenings  
24-395-19  
19 cm



Frenzel  
24-399-16  
16.5 cm



Cawood  
24-425-15  
15.5 cm



24 x 27 mm

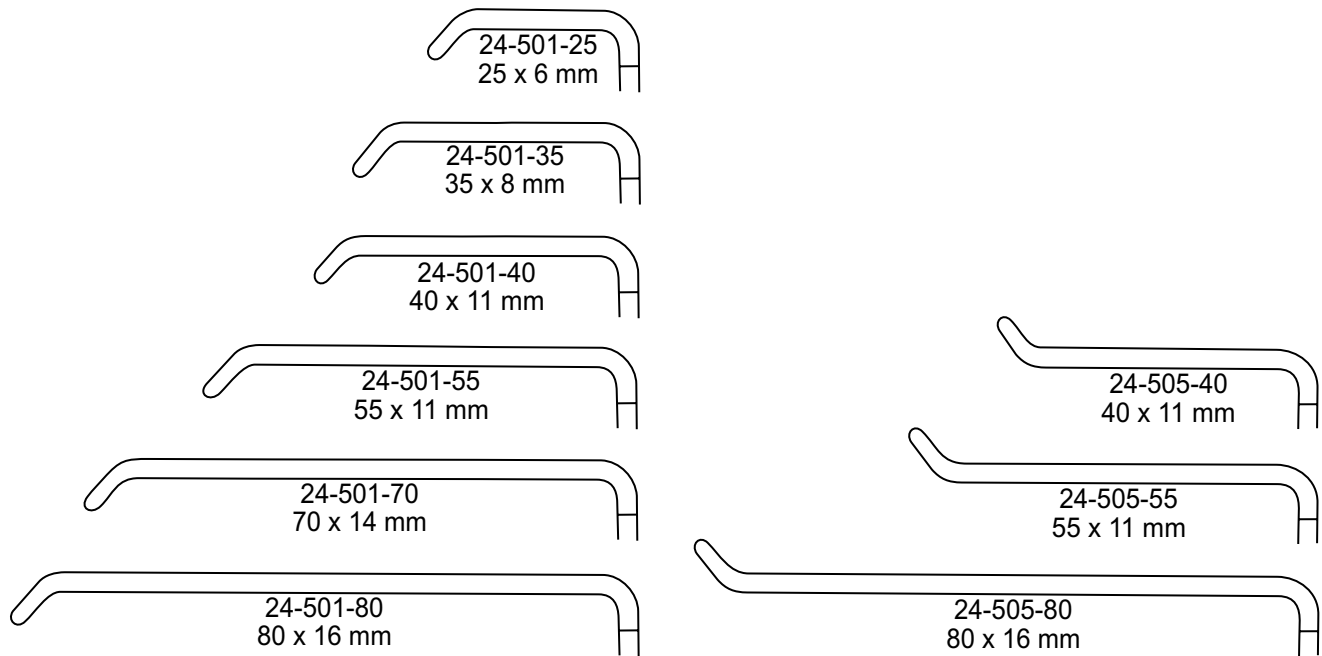
Collin  
24-450-17  
17 cm



rubber inserts

23 x 15 mm  
pair

Young  
24-465-17  
17 cm

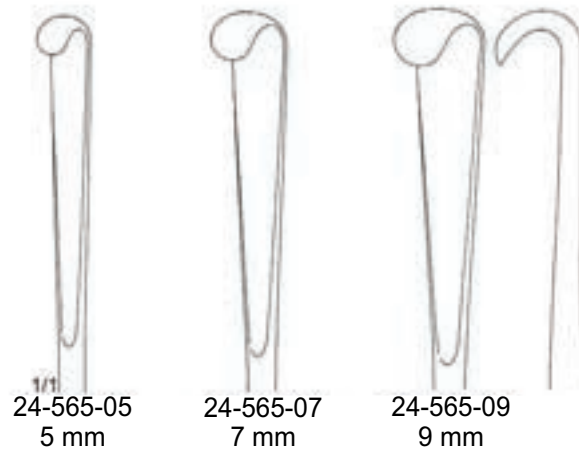
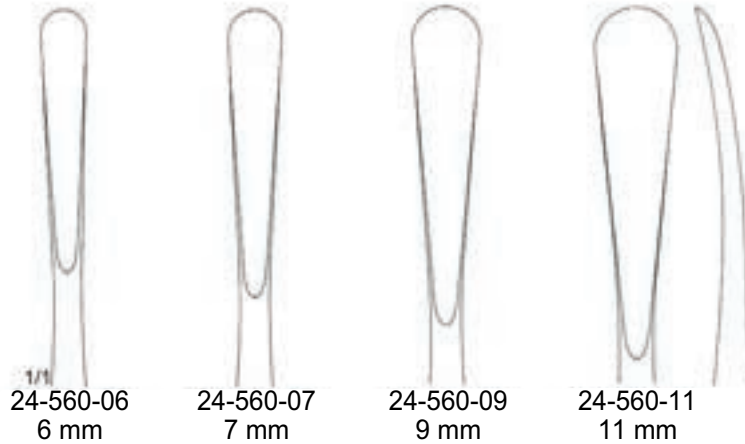


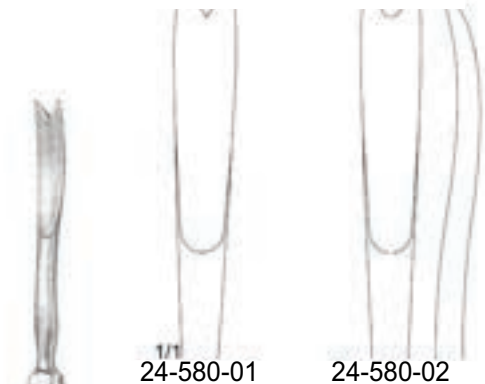
12  
Obwegeser  
24-501-25 - 24-501-80  
21.5 cm

12  
Obwegeser  
24-505-40 - 24-505-80  
22 cm









1/1  
24-580-01

24-580-02

1/2  
Obwegeser

24-580-01 - 24-580-02  
17.5 cm



1/1

1/1

1/2  
Obwegeser  
24-586-21  
21 cm

1/2  
Obwegeser  
24-588-21  
21 cm



24-600-02  
2.5 mm



24-600-04  
4 mm



1/1  
24-600-06  
6.5 mm

1/2  
Obwegeser

24-600-02 - 24-600-06  
15 cm



1/1

1/2  
Obwegeser  
24-606-23  
23.5 cm



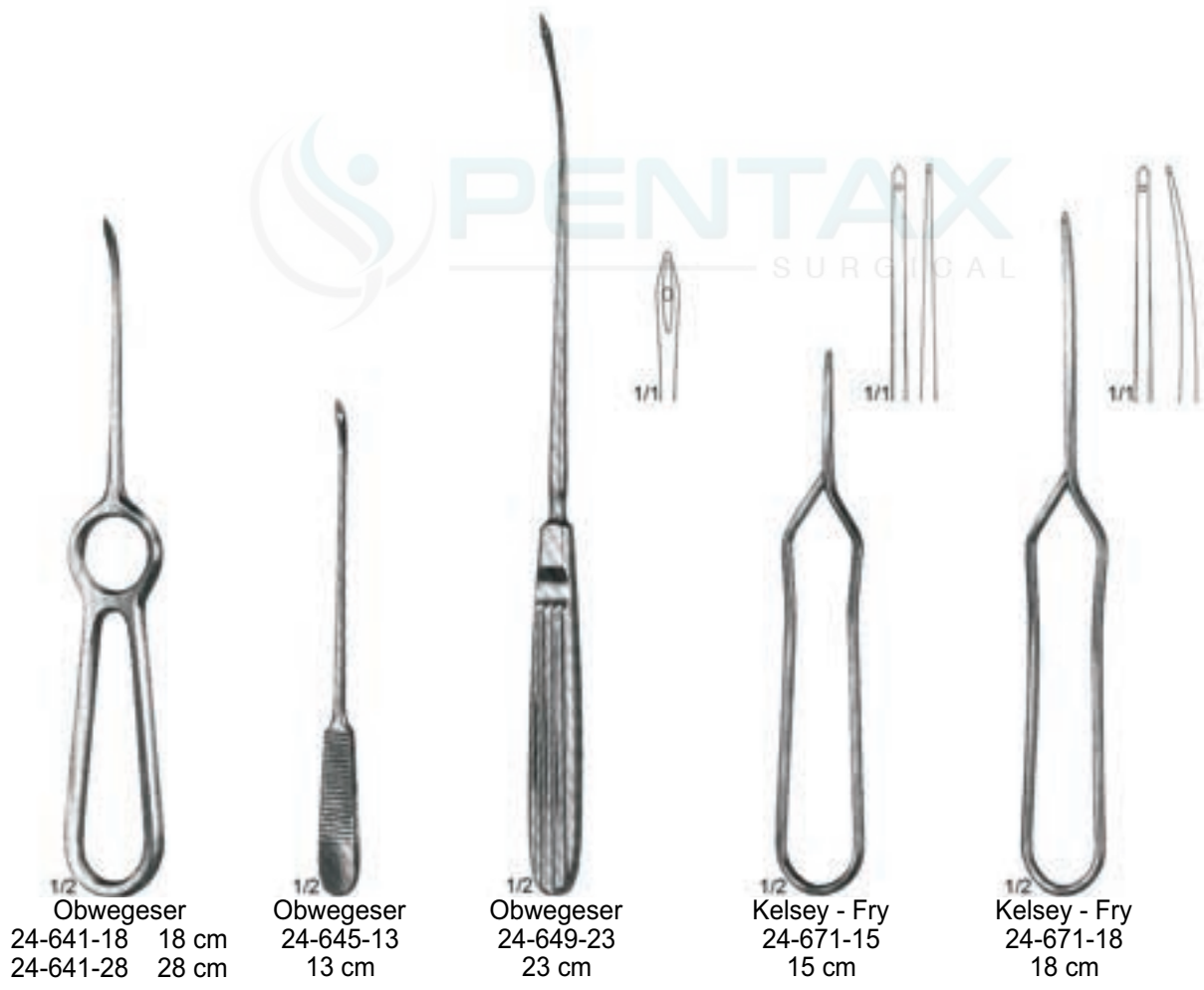
1/1

1/1

24-610-01 24-610-02

1/2  
Obwegeser

24-610-01 - 24-610-02  
18.5 cm



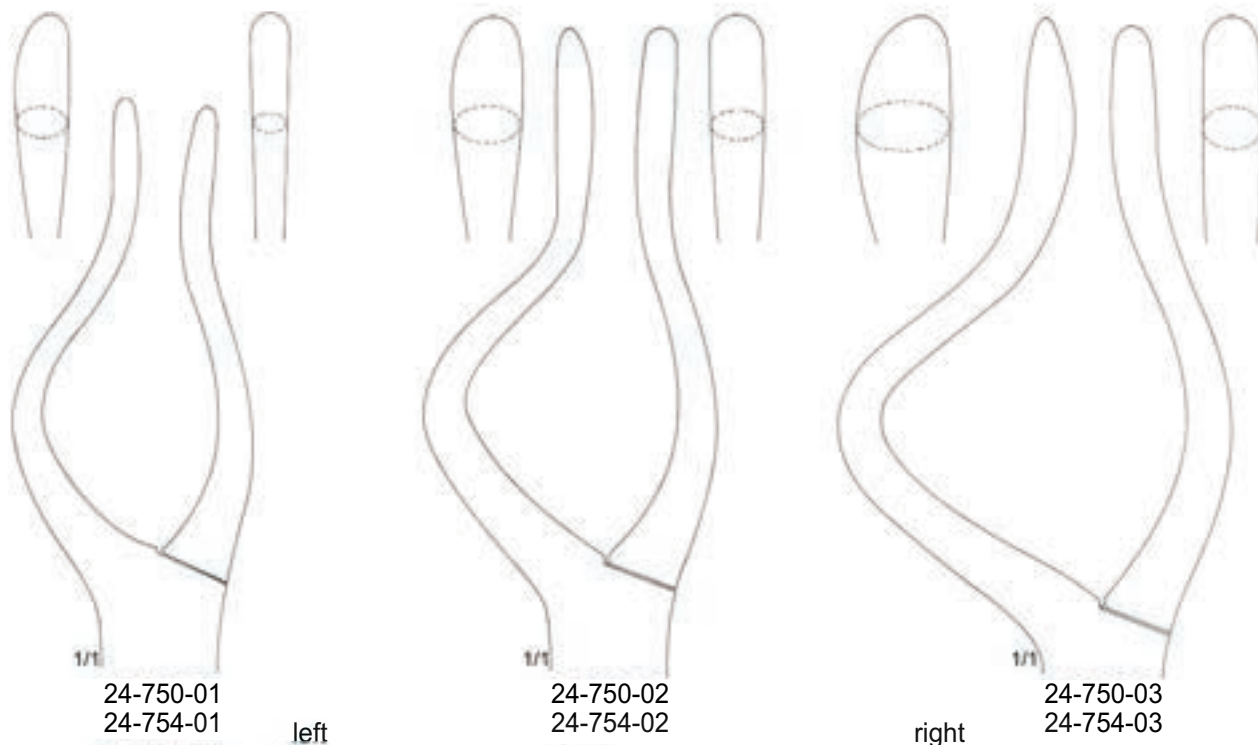
1/2  
 Obwegeser  
 24-641-18 18 cm  
 24-641-28 28 cm

1/2  
 Obwegeser  
 24-645-13  
 13 cm

1/2  
 Obwegeser  
 24-649-23  
 23 cm

1/2  
 Kelsey - Fry  
 24-671-15  
 15 cm

1/2  
 Kelsey - Fry  
 24-671-18  
 18 cm



24-750-01  
24-754-01

24-750-02  
24-754-02

24-750-03  
24-754-03

left

right



Rowe  
24-750-01 - 24-750-03

Rowe  
24-754-01 - 24-754-03



25

curved to left  
for the right hand

curved to right  
for the left hand

curved to left  
for the right hand

curved to right  
for the left hand



Hurd  
25-103-21 - 25-107-21  
21 cm



Dupuy Weiss  
25-113-22 - 25-117-22  
22 cm



Roder  
25-131-26  
26.5 cm



Abraham  
25-151-19  
19 cm



Canfield  
25-153-21  
21 cm



Douglas  
25-157-21  
21 cm



Fisher  
25-159-22  
22.5 cm





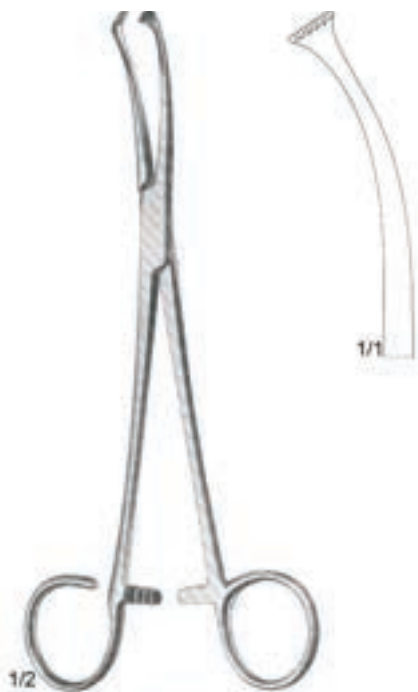


Lopez - Reinke  
 25-231-23  
 23.5 cm

Hofer  
 25-235-24  
 24 cm

Love  
 25-241-18 18 mm  
 25-241-20 20 mm  
 25-241-22 22 mm

Haslinger  
 25-245-17  
 17 cm



White  
 25-281-18  
 18 cm



25-282-19



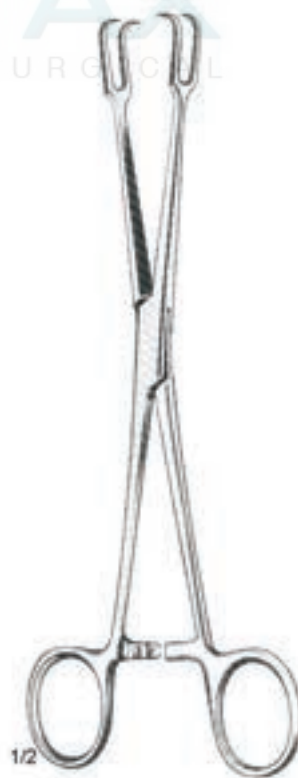
Colver  
 25-282-19 - 25-283-19  
 19 cm



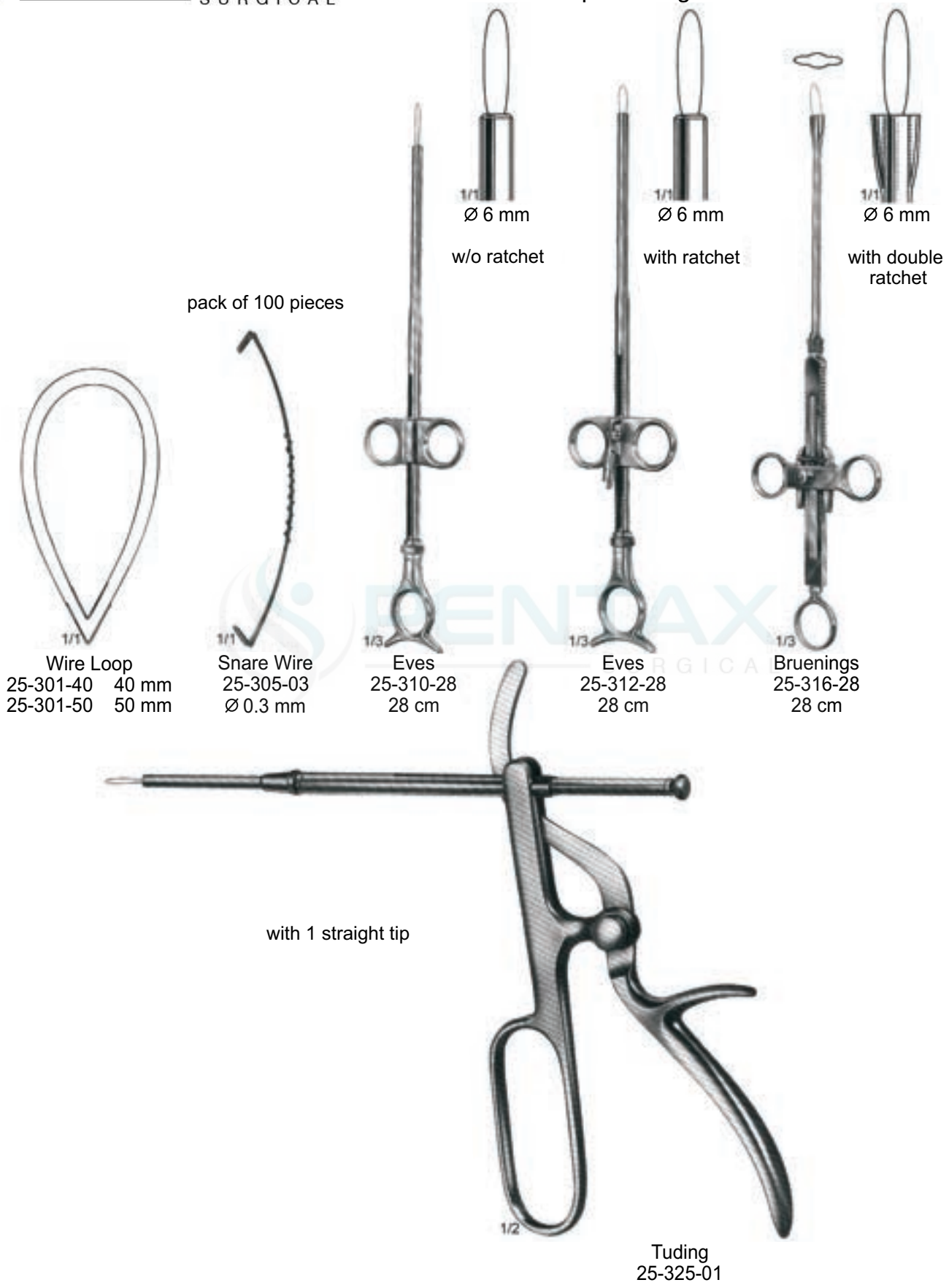
25-283-19

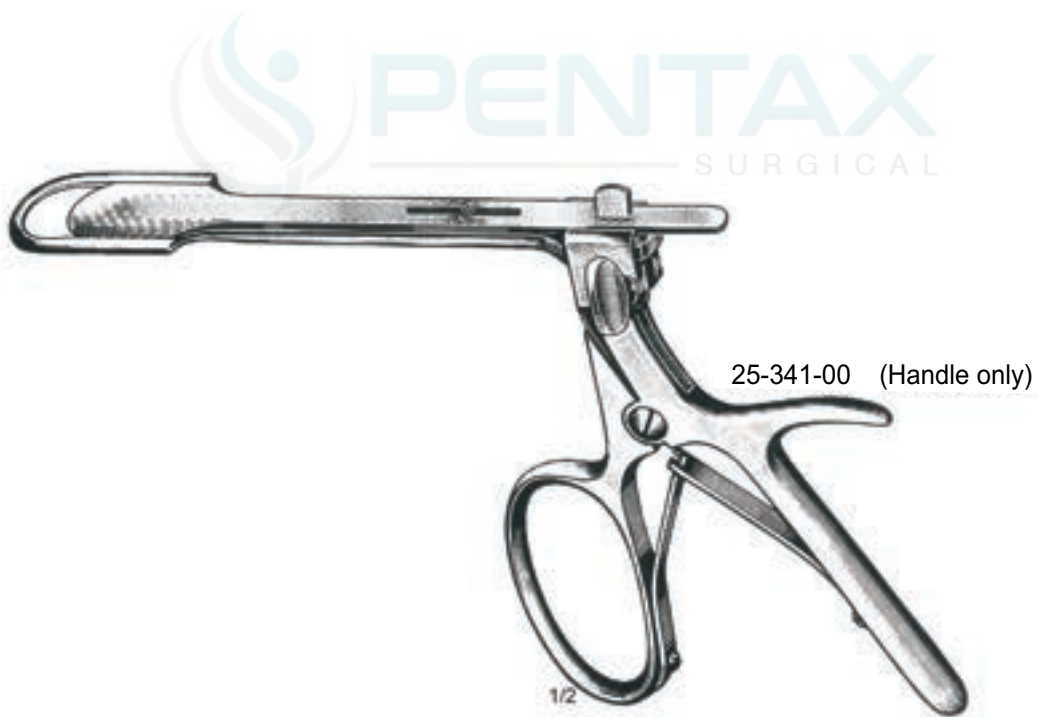
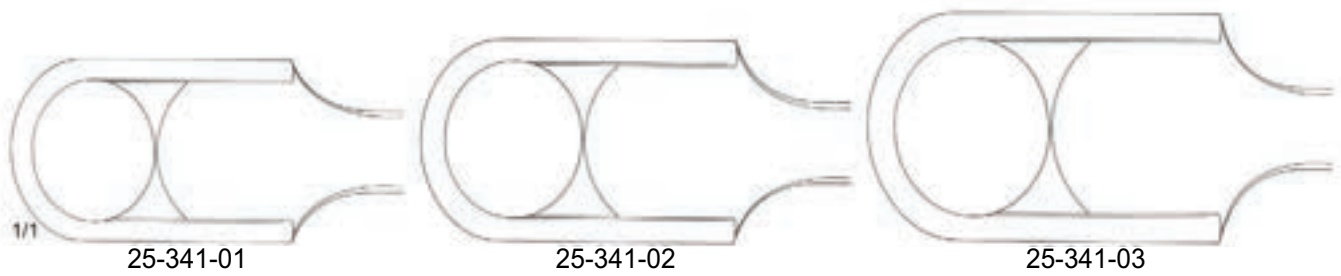


Blohmke  
 25-285-20  
 20 cm  
 1:2 Teeth



Museux  
 25-288-20  
 20 cm





Sluder - Ballenger  
25-340-03  
complete



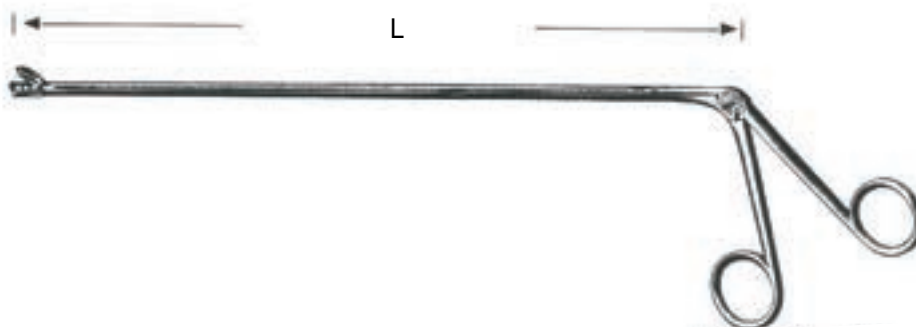
Hartmann  
 25-351-13 - 25-351-17



Corwin  
 25-361-14  
 14 cm



Vetter - Ulrich  
 25-365-15



Chevalier - Jackson  
 25-500-30 - 25-520-60



L = 30 cm  
 L = 40 cm  
 L = 50 cm  
 L = 60 cm

25-500-30  
 25-500-40  
 25-500-50  
 25-500-60

25-502-30  
 25-502-40  
 25-502-50  
 25-502-60

25-504-30  
 25-504-40  
 25-504-50  
 25-504-60

25-506-30  
 25-506-40  
 25-506-50  
 25-506-60



L = 30 cm  
 L = 40 cm  
 L = 50 cm  
 L = 60 cm

25-508-30  
 25-508-40  
 25-508-50  
 25-508-60

25-510-30  
 25-510-40  
 25-510-50  
 25-510-60

25-512-30  
 25-512-40  
 25-512-50  
 25-512-60

25-514-30  
 25-514-40  
 25-514-50  
 25-514-60



L = 30 cm  
 L = 40 cm  
 L = 50 cm  
 L = 60 cm

25-516-30  
 25-516-40  
 25-516-50  
 25-516-60

25-518-30  
 25-518-40  
 25-518-50  
 25-518-60

25-520-30  
 25-520-40  
 25-520-50  
 25-520-60



Huber  
25-531-01



Bruenings  
25-533-01



25-534-20 20 cm  
25-534-30 30 cm  
25-534-40 40 cm



Bruenings  
25-537-20  
20 cm



Fraenkel  
25-550-01



Seiffert  
25-552-01



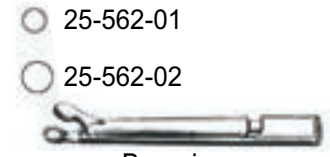
Fraenkel  
25-554-01



Scheinmann  
25-557-01



Scheinmann  
25-559-01



○ 25-562-01  
○ 25-562-02  
Bruenings  
25-564-01 - 25-564-02

○ 25-564-01

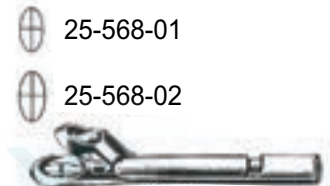
○ 25-564-02



Bruenings  
25-564-01 - 25-564-02



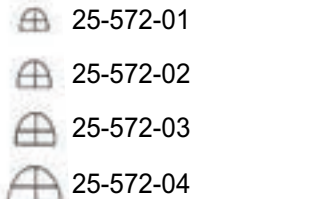
Lange  
25-566-01



⊕ 25-568-01  
⊕ 25-568-02  
Krause  
25-568-01 - 25-568-02



Krause  
25-570-01



⊕ 25-572-01

⊕ 25-572-02

⊕ 25-572-03

⊕ 25-572-04



Cordes  
25-572-01 - 25-572-04



Schumacher  
25-574-01

⊕ 25-576-01

⊕ 25-576-02



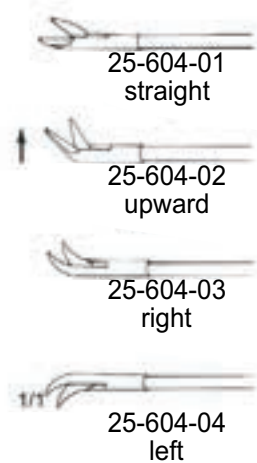
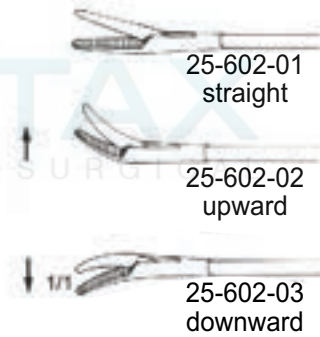
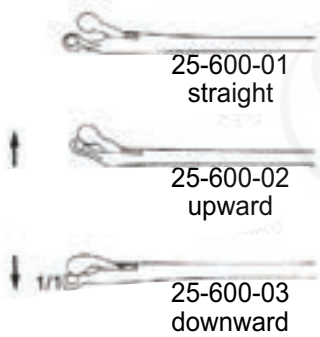
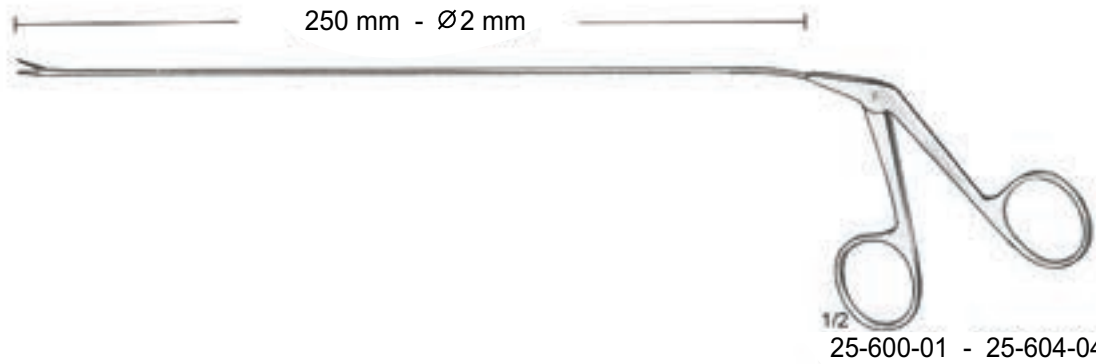
Cordes  
25-576-01 - 25-576-02

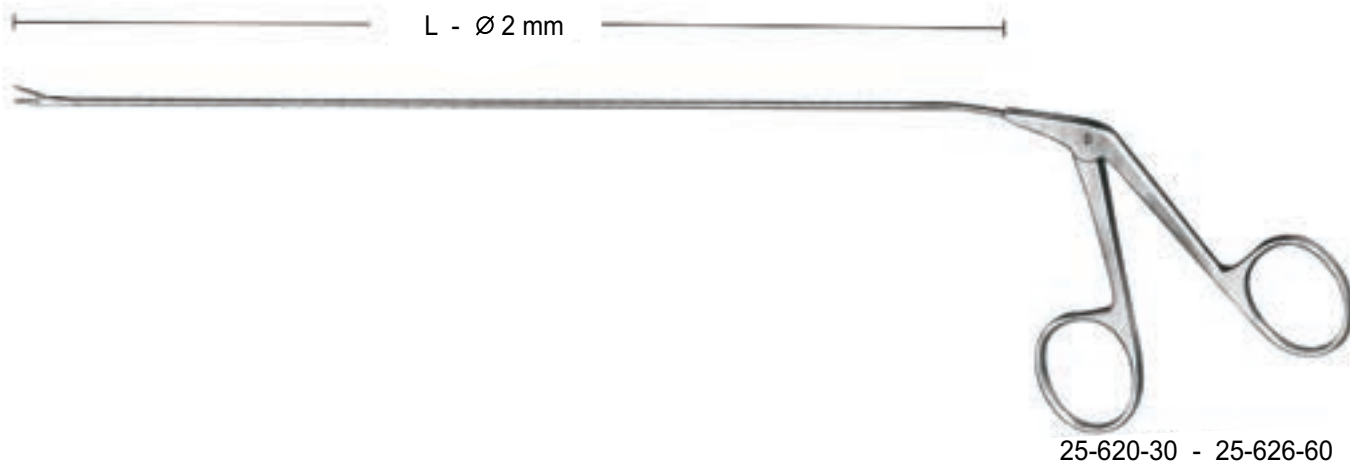


Cordes  
25-578-01



Rosenberg  
25-580-01





L = 30 cm  
L = 35 cm



25-620-30  
25-620-35



25-622-30  
25-622-35



25-624-30  
25-624-35



25-626-30  
25-626-35

L = 40 cm  
L = 45 cm  
L = 50 cm  
L = 55 cm  
L = 60 cm



25-620-40  
25-620-45  
25-620-50  
25-620-55  
25-620-60



25-622-40  
25-622-45  
25-622-50  
25-622-55  
25-622-60



25-624-40  
25-624-45  
25-624-50  
25-624-55  
25-624-60



25-626-40  
25-626-45  
25-626-50  
25-626-55  
25-626-60



plane, with fixed handle

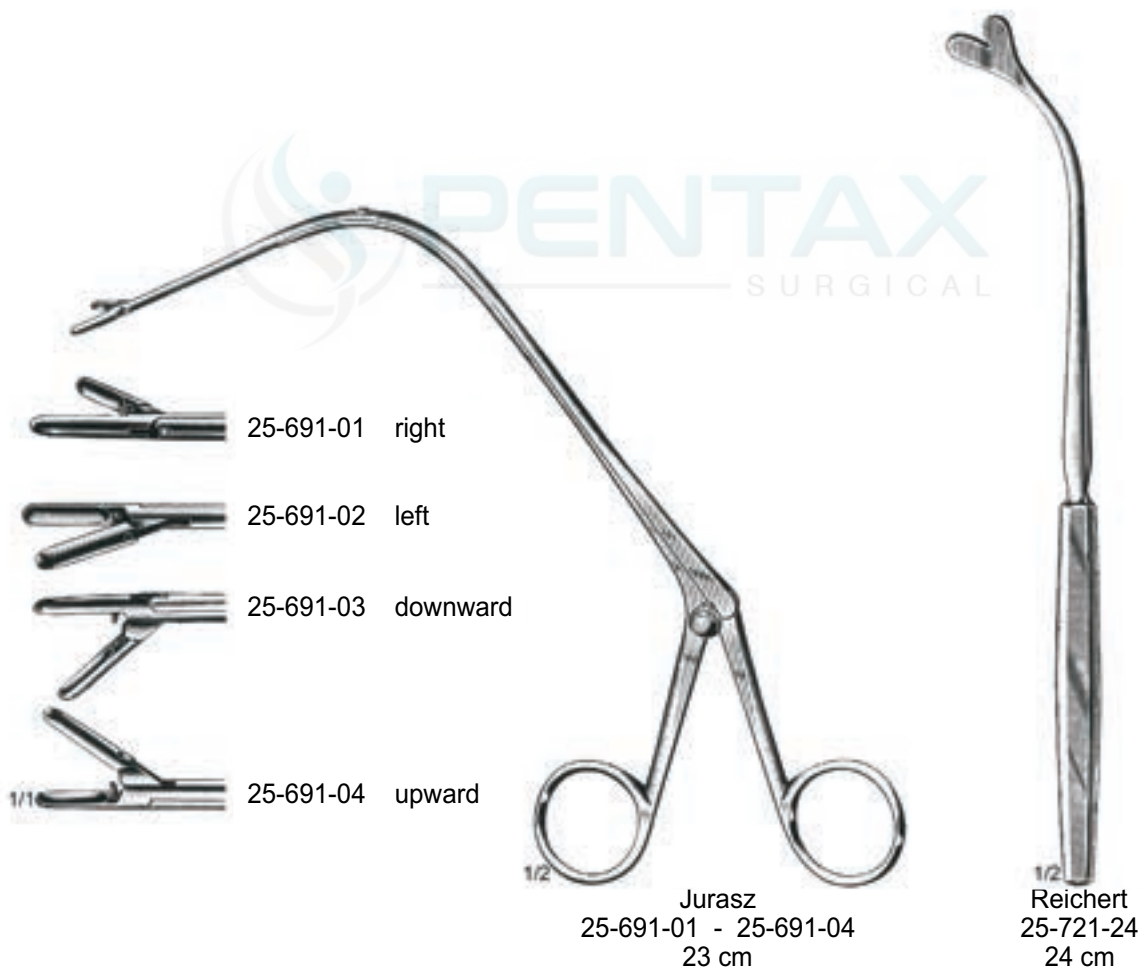


plane, without handle



| Fig. | Ø mm | 25-650-08 | 25-654-08 |
|------|------|-----------|-----------|
| 00   | 8    | 25-650-08 | 25-654-08 |
| 0    | 10   | 25-650-10 | 25-654-10 |
| 1    | 12   | 25-650-12 | 25-654-12 |
| 2    | 14   | 25-650-14 | 25-654-14 |
| 3    | 16   | 25-650-16 | 25-654-16 |
| 4    | 18   | 25-650-18 | 25-654-18 |
| 5    | 20   | 25-650-20 | 25-654-20 |
| 6    | 22   | 25-650-22 | 25-654-22 |
| 7    | 24   | 25-650-24 | 25-654-24 |
| 8    | 26   | 25-650-26 | 25-654-26 |
| 9    | 28   | 25-650-28 | 25-654-28 |
| 10   | 30   | 25-650-30 | 25-654-30 |







Fraenkel  
25-751-26  
26.5 cm



Lange  
25-755-26  
26.5 cm



Fraenkel  
25-785-18  
18 cm

|  |              |   |                           |
|--|--------------|---|---------------------------|
| Adenoid Curettes                               | 23-46—23-48  | Cottle (Collumella) Skin Grasping Forcep  | 23-43                     |
| Adenotomes                                     | 23-48        | Cottle Cartilage Crusher                  | 23-32                     |
| Andrew Tongue Depressor                        | 24-9         | Cottle Guide Support for Osteotomes       | 23-32                     |
| Antrum Punch Forceps                           | 23-17—23-19  | Cottle Handle                             | 23-32                     |
| Antrum Rasps                                   | 23-33        | Cottle Mucosa Hooklet                     | 23-40—23-41               |
| Asch Septum Forcep                             | 23-44        | Cottle Nasal Rasp                         | 23-33                     |
| Aufrecht Glabella Rasp                         | 23-33        | Cottle Nasal Retractor                    | 23-42                     |
| Aufrecht Nasal Retractor                       | 23-40, 23-42 | Cottle Nasal Speculum                     | 23-4—23-5                 |
| Awis   | 24-19        | Cottle Osteotome                          | 23-28                     |
|  |              | Cottle Rhinoplastic and Nasal Knife       | 23-20                     |
|  |              | Cottle Septum and Periosteal Elevator     | 23-24—23-25               |
| <b>B</b>                                       |              | Cottle Skin Grasping Forcep               | 23-43                     |
| Ballenger Septal Knife                         | 23-21        | Cottle-Neivert Alar Hooklet               | 23-41                     |
| Ballenger Septum Gouge                         | 23-27        | Cottle-TC Nasal Rasp                      | 23-39                     |
| Barbara Ear Needle                             | 22-10—22-11  | Cottle-Walsham Septum Forcep              | 23-44                     |
| Barnhill Adenoid Curette                       | 23-47        | Crura and Malleus Nipper                  | 22-7                      |
| Baron (Schuknecht) Suction Tube                | 22-17        | Curettes-Ear                              | 22-12, 22-32—22-33, 22-38 |
| Barth Ear Spoon                                | 22-33        | Curettes-Rhinology                        | 23-45                     |
| Beckmann Adenoid Curette                       | 23-46        | Cutting and Grasping Forceps Tips         | 25-13                     |
| Beckmann Nasal Speculum                        | 23-3, 23-6   |   |                           |
| Belluci Micro Ear Scissor                      | 22-5         | <b>D</b>                                  |                           |
| Beyer Ear Punch                                | 22-31        | Davis-Boyle Mouth Gag                     | 24-4                      |
| Billeau Ear Loop                               | 22-34        | Day Ear Hook                              | 22-35                     |
| Bishop Tongue Depressor                        | 24-8         | Denhart Mouth Gag                         | 24-2                      |
| Blohmke Tonsil Seizing Forcep                  | 25-7         | Dingmann Mouth Gag                        | 24-5                      |
| Boies Rhinoplastic Instrument                  | 23-16        | Disimpaction Forceps                      | 24-20                     |
| Bone Files                                     | 23-33        | Dissectors                                | 25-4, 25-6                |
| Boucheron Ear Speculum                         | 22-19        | Dissectors-Ear                            | 22-12                     |
| Broncho-Esophagoscopy Forceps                  | 25-11        | Douglas Knife                             | 25-3                      |
| Bruenings Cutting Forcep Tip                   | 25-13        | Duplay Nasal Speculum                     | 23-2                      |
| Bruenings Septal Knife                         | 23-21        | Dupuy Weiss Tonsil Needle                 | 25-2                      |
| Bruenings Septum Compression Forcep            | 23-10        |   |                           |
| Bruenings Tongue Depressor                     | 24-11        | <b>E</b>                                  |                           |
| Bruenings Tonsil Snare                         | 25-8         | Ear Dressing Forceps                      | 22-28                     |
| Bruenings Universal Handle                     | 25-12        | Ear Polypus Forcep                        | 22-29—22-30               |
| Buchwald Tongue Depressor                      | 24-11        | Ear Polypus Snares                        | 22-27                     |
| Buck Ear Curette                               | 22-32—22-33  | Ear Punches                               | 22-31                     |
| Buck Foreign Body Lever                        | 22-29        | Ear Specula                               | 22-18—22-20               |
| Buck Paracentesis Needle                       | 22-36        | Ear Specula Holder                        | 22-20                     |
| Buckingham Foot Plate Instrument               | 22-13        | Ear Syringe                               | 22-40                     |
|  |              | Eicken Killian Irrigation Cannula         | 23-49                     |
| <b>C</b>                                       |              | Elevators-Ear                             | 22-12, 22-38—22-39        |
| Canfield Knife                                 | 25-3         | Endolaryngeal Micro Surgery Forcep        | 25-14                     |
| Caplan Septum Scissor                          | 23-15        | Enucleators                               | 25-4                      |
| Carpenter Tonsil Knife                         | 25-4         | Epiglottis Retractors                     | 25-18                     |
| Cawfood Retractor                              | 24-12        | Eustachian Catheters                      | 22-27                     |
| Cheek-Lip Retractors                           | 24-7—24-9    | Eves Tonsil Snare                         | 25-8                      |
| Chevalier-Jackson Broncho-Esophagoscopy Forcep | 25-11        |   |                           |
| Chin Retractors and Channelled Retractors      | 24-16        | <b>F</b>                                  |                           |
| Chisel Maxillo-Facial Surgery                  | 24-18        | Farrior Ear Speculum                      | 22-19                     |
| Chisels  | 23-29, 23-31 | Faulkner Curette                          | 23-45                     |
| Cinelli Chisel                                 | 23-29        | Ferris Smith Kerrison Antrum Punch Forcep | 23-19                     |
| Citelli Ear Punch                              | 22-31        | Ferris-Smith-Kerrison (Cloward Harper)    | 23-18                     |
| Cleft Plate Needles                            | 25-2         | Antrum Punch Forcep                       |                           |
| Coakley Curette                                | 23-45        | Fisch Elevator                            | 22-12                     |
| Collin Tongue Holding Forcep                   | 24-13        | Fisher Tonsil Knife                       | 25-3                      |
| Colver Tonsil Seizing Forcep                   | 25-7         | Fomon Alar Hooklet                        | 23-41                     |
| Converse Chisel                                | 23-31        | Fomon Chisel                              | 23-29                     |
| Converse Mucosa Hooklet                        | 23-40        | Fomon Mucosa Hooklet                      | 23-40                     |
| Converse Nasal Rasp                            | 23-35        | Fomon Nasal Rasp                          | 23-34                     |
| Converse Rhinoplastic and Nasal Knife          | 23-20        | Fomon Rhinoplastic and Nasal Knife        | 23-20                     |
| Cordes Cutting Forcep Tip                      | 25-13        | Fomon-TC Nasal Rasp                       | 23-38                     |
| Corwin Tonsil Hemostats                        | 25-10        |   |                           |

Forceps for Laryngo Bronchoscopy  
 Foreign Body Instruments  
 Foreign Body Levers  
 Fraenkel Grasping Forcep Tip  
 Fraenkel Laryngeal Polypus Forcep  
 Freer Mucosa Hooklet  
 Freer Rhinoplastic and Nasal Knife  
 Freer Septal Knife  
 Freer Septum Chisel  
 Freer Septum Elevator  
 Freer Septum Gouge  
 French Tuning Fork  
 Frenzel Tongue Depressor  
 Fuller Crura and Malleus Nipper

## G

Gallaher Antrum Rasp 23-33  
 Gerzog-Sexton Paracentesis Needle 22-36  
 Glabella Rasps 23-33  
 Goldmann Rhinoplastic Instrument 23-16  
 Goldsmith Nasal Speculum 23-2  
 Graig Septum Compression Forcep 23-10  
 Graig-Domnick Septum Compression Forcep 23-10  
 Greven Wire Closure Forcep 22-6  
 Gross Ear Hook 22-34  
 Gruber Ear Speculum 22-18  
 Gruenwald (Jansen) Nasal Dressing Forcep 23-8  
 Gruenwald Nasal Cutting Forcep 23-13  
 Guilen Irrigation Cannula 23-49

## H

Hajek Nasal Cutting Forcep 23-13  
 Hajek-Claus Antrum Punch Forcep 23-19  
 Hajek-Koffler Antrum Punch Forcep 23-17  
 Halle Septum Elevator 23-23  
 Handle for Laryngeal Mirrors 25-17  
 Hartmann Ear Hook 22-34  
 Hartmann Ear Polypus Forcep 22-29—22-30  
 Hartmann Ear Speculum 22-18  
 Hartmann Eustachian Catheter 22-27  
 Hartmann Nasal Cutting Forcep 23-13  
 Hartmann Nasal Polypus Forcep 23-8—23-9  
 Hartmann Nasal Speculum 23-6  
 Hartmann Tongue Depressor 24-9  
 Hartmann Tonsil Punch Forcep 25-10  
 Hartmann Tuning Fork 22-21, 22-23, 22-25  
 Hartmann-Halle Nasal Speculum 23-2  
 Hartmann-Hoffmann Ear Polypus F orcep 22-30  
 Hartmann-Noyes Ear Polypus Forcep 22-30  
 Hartmann-Wängartner Ear Polypus Forcep 22-30  
 Hartmann-Wullstein Ear Polypus Forcep 22-30  
 Haslinger Tonsil Retractor 25-6  
 Hass Tongue Depressor 24-11  
 Heister Mouth Gag 24-2  
 Henke Enucleators 25-4  
 Heymann Septum Compression Forcep 23-9  
 Heymann-Knight Nasal Polypus Forcep 23-8  
 Hofer Tonsil Retractor 25-6  
 Hooklets-Ear 22-15, 22-35  
 Hooks-Ear 22-34  
 House Dissector 22-12  
 House Foot Plate Instrument 22-13  
 House Suction Tube 22-17  
 House-Dieter Crura and Malleus Nipper 22-7  
 Huber Universal Handle 25-12

22-13  
 22-14  
 25-15  
 22-34  
 22-29  
 25-13  
 25-19  
 23-40  
 23-22  
 23-21  
 23-26  
 23-23  
 23-26  
 22-21  
 24-11  
 22-7

Hurd Cleft Plate Needle 25-2  
 Hurd Tonsil Dissector 25-4

## J

Jansen Ear Dressing Forcep 22-28  
 Jansen Ear Spoon 22-33  
 Jansen-Middleton Septum Compression Forcep 23-14  
 Jennings Mouth Gag 24-6  
 Joseph Bone File 23-33  
 Joseph Mucosa Hooklet 23-40—23-41  
 Joseph Nasal Saw 23-30  
 Joseph Rhinoplastic and Nasal Knife 23-20, 23-22  
 Joseph Septum and Periosteal Elevator 23-25  
 Joseph Septum Elevator 23-23  
 Joseph-Masing Septum and Periosteal Elevator 23-25  
 Juers Wire Closure Forcep 22-6  
 Jurasz Laryngeal Polypus Forcep 25-18

## K

Kelsey-Fry Awis 24-19  
 Kerrison Antrum Punch Forcep 23-19  
 Killian Nasal Polypus Forcep 23-9  
 Killian Nasal Speculum 23-3  
 Killian Septum and Periosteal Elevator 23-24  
 Killian Septum Gouge 23-26  
 Killian Septum Scissor 23-15  
 Killian-Claus Septum Gouge 23-26  
 Kilner Mucosa Hooklet 23-40  
 Kilner-Doughty Mouth Gag 24-3  
 Knight Septum Compression Forcep 23-9  
 Koenig Tuning Fork 22-26  
 Krause Cutting Forcep Tip 25-13  
 Krause Nasal Snare 23-7  
 Krause Polypus Snare 22-27  
 Krause-Voss Nasal Snare 23-7  
 Krause-Voss Polypus Snare 22-27  
 Kressner Rhinoplastic Instrument 23-16  
 Kroenig Tongue Depressor 24-10

## L

La Force Adenotome 23-48  
 Lange Grasping Forcep Tip 25-13  
 Lange Laryngeal Polypus Forcep 25-19  
 Lange Mucosa Hooklet 23-40  
 Langenbeck Ear Curette 22-32  
 Lange-Wilde Nasal Snare 23-7  
 Larkin Foot Plate Instrument 22-13  
 Laryngeal Mirrors 25-16—25-17  
 Laryngeal Polypus Forceps 25-18—25-19  
 Lempert Curette 22-38  
 Lempert Elevator 22-38—22-39  
 Lempert Raspatory 22-38  
 Lewis Nasal Rasp 23-33  
 Lewis-TC Nasal Rasp 23-39  
 Ligation Carriers 25-3  
 Littauer Ear Polypus Forcep 22-29  
 Littauer Nasal Polypus Forcep 23-9  
 Loops-Ear 22-34—22-35  
 Lopez-Reinke Tonsil Dissector 25-6  
 Love Tonsil Retractor 25-6  
 Lubet-Barbon Nasal Polypus Forcep 23-8  
 Luc Septum Compression Forcep 23-10

|  |                          |   |                            |
|--|--------------------------|---|----------------------------|
| Lucae Paracentesis Needle                  | 22-28                    | Surgery                                   |                            |
| Lucae Tuning Fork                          | 22-35                    | Obwegeser Periosteal Elevator             | 24-17—24-18                |
| Luniatschek Tonsil Packer                  | 22-36                    | Obwegeser Ramus Retractor                 | 24-15                      |
|  | 22-24—22-25              | Obwegeser Soft Tissue Retractor           | 24-14                      |
|  | 25                       | Ogura Skin Grasping Forcep                | 23-43                      |
|  | 25-5                     | Oringer Cheek-Lip Retractor               | 24-7                       |
|  |                          | Osteotome Maxillo-Facial Surgery          | 24-18                      |
|  |                          | Osteotomes                                | 23-28—23-30, 23-31         |
| <b>M</b>                                   |                          | <b>P</b>                                  |                            |
| Maltz Nasal Rasp                           | 23-33                    | Paracentesis Knife                        | 22-37                      |
| Maltz Rhinoplastic and Nasal Knife         | 23-22                    | Paracentesis Needles                      | 22-36—22-37                |
| Maltz-T/C Nasal Rasp                       | 23-37                    | Pennington Septum and Periosteal Elevator | 23-24                      |
| Marschik Tonsil Forcep                     | 25-5                     | Periosteal Elevator                       | 24-17—24-18                |
| Masing Chisel                              | 23-31                    | Picks and Hooks                           | 22-10—22-11                |
| Masing Nasal Rasp                          | 23-35                    | Pierce Septum and Periosteal Elevator     | 23-24                      |
| Masing Rhinoplastic and Nasal Knife        | 23-20                    | Plester Ear Instrument                    | 22-12                      |
| Masing Septum and Periosteal Elevator      | 23-25                    | Plester Micro Ear Knife                   | 22-9                       |
| Mayo Tongue Depressor                      | 24-10                    | Politzer Ear Speculum                     | 22-18                      |
| Mc Ivor Mouth Gag                          | 24-4                     | Politzer Paracentesis Needle              | 22-36—22-37                |
| McGee Picks and Hooks                      | 22-11                    | Probes-Rhinology                          | 23-49                      |
| McGee Wire Closure Forcep                  | 22-6                     | <b>Q</b>                                  |                            |
| McKenty Septum and Periosteal Elevator     | 23-24                    | Quire Foreign Body Lever                  | 22-29                      |
| McKenty Septum Elevator                    | 23-23                    | Quire Nasal Polypus Forcep                | 23-9                       |
| Michel Laryngeal Mirror                    | 25-17                    | <b>R</b>                                  |                            |
| Micro Ear Forceps                          | 22-2—22-4, 22-8          | Ramus Retractors                          | 24-15                      |
| Micro Ear Knives                           | 22-9                     | Raspatories                               | 22-38                      |
| Micro Ear Scissors                         | 22-5                     | Reichert Epiglottis Retractor             | 25-18                      |
| Micro Sinuscopy Forcep                     | 23-55                    | Rhinoplastic and Nasal Knives             | 23-20, 23-22               |
| Miller-Colburn Nasal Rasp                  | 23-36                    | Rhinoplastic Instruments                  | 23-16, 23-36, 23-30, 23-32 |
| Mini Mc Gee Alligator Forcep               | 22-2                     |   | — 23-34, 23-37—23-44       |
| Minnesota Retractor                        | 24-12                    | Richnau Holmgren Ear Speculum             | 22-20                      |
| Mobilizers-Ear                             | 22-12                    | Ritter-Halle Probe                        | 23-49                      |
| Mod. Martin Cheek-Lip Retractor            | 24-8                     | Roder Ligature Carrier                    | 25-3                       |
| Mod.Wien Nasal Speculum                    | 23-3                     | Roger Septum and Perisoteal Elevator      | 23-25                      |
| Modell Wurzburg Tongue Plate for Mouth Gag | 24-5                     | Rosen Curette                             | 22-12                      |
| Moldenhauer Foreign Body Instrument        | 22-34                    | Rosen Ear Needle                          | 22-10—22-11                |
| Molt Mouth Gag                             | 24-2                     | Rosen Elevator                            | 22-12                      |
| Moritz-Schmidt Tongue Depressor            | 24-10                    | Rosen Micro Ear Knife                     | 22-9                       |
| Mouth Gags                                 | 24-2—24-6                | Rosen Mobilizer                           | 22-12                      |
| Mucosa Hooklets                            | 23-40—23-41              | Rosenberg Grasping Forcep Tip             | 25-13                      |
|  | 41                       | Rosen-Konig Mouth Gag                     | 24-2                       |
| Museux Tonsil Seizing Forcep               | 25-7                     | Rowe Disimpaction Forcep                  | 24-20                      |
| Myles Nasal Cutting Forcep                 | 23-13                    | Rubin Osteotome                           | 23-29                      |
|  |                          | Rubin Septum Forcep                       | 23-15                      |
|  |                          | Rubin-TC Septum Forcep                    | 23-15                      |
|  |                          | Rydel-Seiffert Tuning Fork                | 22-26                      |
|  |                          | <b>S</b>                                  |                            |
|  |                          | Scheinmann Grasping Forcep Tip            | 25-13                      |
|  |                          | Schmeden Nasal Cutting Forcep             | 23-13                      |
|  |                          | Schuknecht Ear Needle                     | 22-16                      |
|  |                          | Schuknecht Micro Ear Knife                | 22-9                       |
|  |                          | Schuknecht Wire Closure Forcep            | 22-6                       |
|  |                          | Schumacher Cutting Forcep Tip             | 25-13                      |
|  |                          | Seemann-Seiffert Mouth Gag                | 24-6                       |
|  |                          | Seiffert Grasping Forcep Tip              | 25-13                      |
| <b>N</b>                                   |                          |   |                            |
| Nager Tonsil Retractor                     | 25-5                     |   |                            |
| Nasal Cutting Forcep                       | 23-11—23-13              |   |                            |
| Nasal Dressing Forceps                     | 23-8                     |   |                            |
| Nasal Polypus Forcep                       | 23-8—23-10               |   |                            |
| Nasal Rasps                                | 23-34—23-39              |   |                            |
| Nasal Retractors                           | 23-40, 23-42             |   |                            |
| Nasal Saws                                 | 23-30                    |   |                            |
| Nasal Snares                               | 23-7                     |   |                            |
| Nasal Specula                              | 23-2—23-6                |   |                            |
| Needles-Ear                                | 22-10—22-11, 22-15—22-16 |   |                            |
| Negus Chest Support for Mouth Gag          | 24-5                     |   |                            |
| Neivert Nasal Retractor                    | 23-42                    |   |                            |
| Neivert Osteotome                          | 23-31                    |   |                            |
| <b>O</b>                                   |                          |   |                            |
| Obwegeser Awis                             | 24-19                    |   |                            |
| Obwegeser Chin and Channelled Retractor    | 24-16                    |   |                            |
| Obwegeser Chisel                           | 24-18                    |   |                            |
| Obwegeser Osteotome Maxillo-Facial         | 24-18                    |   |                            |

|   |                   |  |  |
|---|-------------------|--|--|
| Septum Chisels                              | 23-24—23-25       |  |  |
| Septum Compression Forceps                  | 23-26—23-27       |  |  |
| Septum Elevators                            | 23-9—23-10, 23-14 |  |  |
| Septum Forceps                              | 23-23             |  |  |
| Septum Gouges                               | 23-15, 23-44      |  |  |
| Septum Knives                               | 23-26—23-27       |  |  |
| Septum Scissors                             | 23-21             |  |  |
| Sexton Paracentesis Needle                  | 23-15             |  |  |
| Shambaugh-Derlacki Elevator                 | 22-36             |  |  |
| Shapleigh Ear Curette                       | 22-39             |  |  |
| Shea Foot Plate Instrument                  | 22-32             |  |  |
| Sheehan Osteotome                           | 22-13             |  |  |
| Siebenmann Wash Catheter                    | 23-29             |  |  |
| Silver Osteotome                            | 23-49             |  |  |
| Simplex Check-Lip Retractor                 | 23-30             |  |  |
| Sinuscopy Forceps                           | 24-8              |  |  |
| Skin Grasping Forceps                       | 23-50—23-56       |  |  |
| Sluder-Ballenger Tonsillectome              | 23-43             |  |  |
| Snellen Ear Loop                            | 25-9              |  |  |
| Soft Tissue Retractors                      | 22-35             |  |  |
| Sphenoid Punches                            | 24-14             |  |  |
| Spoons-Ear                                  | 23-17—23-19       |  |  |
| Sprague Paracentesis Needle                 | 22-33             |  |  |
| Sprauge Paracentesis Knife                  | 22-37             |  |  |
| St. Clair-Thompson Adenoid Curette          | 22-37             |  |  |
| Stammberger Sinuscopy Forceps               | 23-47             |  |  |
| Standard Sinuscopy Forceps                  | 23-56             |  |  |
| Standard Tongue Depressor                   | 23-54             |  |  |
| Stanzen Punch Sinuscopy Forceps             | 24-10             |  |  |
| Stenberg Check-Lip Retractor                | 23-53             |  |  |
| Struempel Ear Polypus Forceps               | 24-8              |  |  |
| Struycken Nasal Cutting Forceps             | 22-30             |  |  |
| Struycken Septum Compression Forceps        | 23-12             |  |  |
| Struycken Sinuscopy Forceps                 | 23-14             |  |  |
| Suction Tubes-Ear                           | 23-52             |  |  |
|   | 22-17             |  |  |
| <b>T</b>                                    |                   |  |  |
| Tabb Micro Ear Knife                        | 22-9              |  |  |
| Takahashi Nasal Cutting Forceps             | 23-11             |  |  |
| Takahashi Sinuscopy Forceps                 | 23-52             |  |  |
| Thudicum Nasal Speculum                     | 23-2              |  |  |
| Tieck-Halle Nasal Speculum                  | 23-3              |  |  |
| Tobold Tongue Depressor                     | 24-9              |  |  |
| Tongue Depressors                           | 24-8—24-11        |  |  |
| Tongue Holding Forceps                      | 24-13             |  |  |
| Tonsil Forceps                              | 25-5              |  |  |
| Tonsil Hemostats                            | 25-10             |  |  |
| Tonsil Knives                               | 25-3—25-4         |  |  |
| Tonsil Needles                              | 25-2              |  |  |
| Tonsil Packers                              | 25-5              |  |  |
| Tonsil Punch Forceps                        | 25-10             |  |  |
| Tonsil Retractors                           | 25-5—25-6         |  |  |
| Tonsil Seizing Forceps                      | 25-7              |  |  |
| Tonsil Snares                               | 25-8              |  |  |
| Tonsillectomes                              | 25-9              |  |  |
| Toynbee Ear Speculum                        | 22-18             |  |  |
| Troeltsch (Wilde) Ear Dressing Forceps      | 22-28             |  |  |
| Troeltsch Nasal Dressing Forceps            | 23-8              |  |  |
| Tuding Tonsil Snare                         | 25-8              |  |  |
| Tuning Forks                                | 22-21—22-26       |  |  |
| <b>U</b>                                    |                   |  |  |
| Univ. Minnesota Tongue Depressor            | 24-10             |  |  |
| Universal Handles and Interchangeable Tubes | 25-12             |  |  |
| <b>V</b>                                    |                   |  |  |
| Vetter-Ulrich Tonsil Hemostats              | 25-10             |  |  |
| Voltolini Nasal Speculum                    | 23-2              |  |  |
| <b>W</b>                                    |                   |  |  |
| Wagener Ear Hook                            | 22-35             |  |  |
| Walsham Septum Forceps                      | 23-44             |  |  |
| Walter Chisel                               | 23-29             |  |  |
| Walter Osteotome                            | 23-29             |  |  |
| Wash Cannulas-Rhinology                     | 23-49             |  |  |
| Wash Catheters-Rhinology                    | 23-49             |  |  |
| Watson-Williams Nasal Cutting Forceps       | 23-11             |  |  |
| Weil Nasal Cutting Forceps                  | 23-11             |  |  |
| Weil-Blakesley Nasal Cutting Forceps        | 23-12             |  |  |
| Weil-Blakesley Sinuscopy Forceps            | 23-50—23-52       |  |  |
| West Septum Chisel                          | 23-27             |  |  |
| West Septum Gouge                           | 23-27             |  |  |
| Westmacott Nasal Polypus Forceps            | 23-8              |  |  |
| White Tonsil Seizing Forceps                | 25-7              |  |  |
| Whitehead Mouth gag                         | 24-6              |  |  |
| Wieder Tongue Depressor                     | 24-9              |  |  |
| Wiener Nasal Rasp                           | 23-34             |  |  |
| Wire Closure Forceps                        | 22-6              |  |  |
| Wullstein Elevator                          | 22-39             |  |  |
| Wullstein Micro Ear Forceps                 | 22-8              |  |  |
| Wullstein Micro Ear Knife                   | 22-9              |  |  |
| Wullstein Micro Ear Scissor                 | 22-5              |  |  |
| Wullstein Suction Tube                      | 22-17             |  |  |
| <b>Y</b>                                    |                   |  |  |
| Young Tongue Holding Forceps                | 24-13             |  |  |
| <b>Z</b>                                    |                   |  |  |
| Zaufal Foreign Body Instrument              | 22-34             |  |  |
| Zollner Ear Hooklet                         | 22-15             |  |  |
| Zollner Ear Needle                          | 22-15             |  |  |
| Zollner Ear Speculum                        | 22-19             |  |  |
| Zollner Suction Tube                        | 22-17             |  |  |