

Contents

General Instruments

Scalpel Handles	04-2
Razor Blade Holders and Breakers	04-3
Fine Operating Scissors	05-2
Eye Scissors	05-6
Iris Scissors	05-12
Secondary Cataract Scissors	05-13
Tenotomy Scissors, Corneal Scissors	05-14
Corneal Section Scissors	05-15
Cartilage, Labectomy and Enterotomy Scissors	05-17
Fine Pattern Forceps	06-2
Micro Forceps	06-4
Splinter Forceps	06-6
Cilia Forceps	06-6
Bulldog Clamps	07-2
Artery Forceps	07-3
Towel Forceps	07-5
Micro-Needle Holders	11-2
Micro-Needle Holders with Tungsten Carbide Inserts	11-15

Ophthalmology

Eye Scalpels	26-2
Cataract Knives	26-2
Eye Knives	26-4
Keratomes	26-5
Corneal Knives	26-8
Foreign Body Instruments	26-11
Cystotomes	26-14
Iris Hooks	26-15
Hooks	26-16
Retractors	26-18
Lid Instruments	26-19
Eye Specula	26-20
Orbit Spatulas	26-25
Cyclodialysis Spatulas	26-26
Spatulas	26-28
Lens Scoops	26-29
Lens Manipulators	26-30
Lens Expressors	26-31
Spoons	26-31
Chalazion Curettes	26-32
Dissectors	26-33
Keratoplastic Knives, Punches, Chisels	26-34
Micro Scissors	27-2
Keratomy Scissors	27-3
Iris Scissors	27-3

Corneal Scissors	27-4
Tenotomy Scissors	27-4
Capsulotomy Scissors	27-5
Corneal Scissors	27-6
Caliper / Markers	27-7
Trabecular Probes, Lachrymal Probes	27-8
Lachrymal Dilators and Probes	27-9
Double – Ended Instruments	27-10
Iris Forceps	27-12
Conjunctival Forceps	27-15
Suture Forceps	27-17
Fixation Forceps	27-20
Capsular Forceps	27-23
Lens Implantation	27-26
Tissue Forceps	27-29
Strabismus Forceps	27-31
Muscular Forceps	27-32
Advancement and Entropium Forceps	27-34
Chalazion Forceps	27-35
Skeleton Forceps, Fixation Forceps (Colibri)	27-36
Ligature Needles	27-37
Eye Cannulas	28-2





04, 05, 06

for Fig. 10 - 17

for Fig. 18 - 36

for Fig. 10 - 17



Standard
 04-150-03
 12 cm
 No. 3



Standard
 04-170-04
 12 cm
 No. 4



04-200-07
 16 cm
 No. 7



Troutman - Chris
 04-310-10
 Ø5.5 mm
 10 cm



Troutman - Chris
 04-311-10
 Ø5.5 mm
 10 cm



04-320-11
 11 cm



Castroviejo
 04-330-13
 Ø8 mm
 13 cm

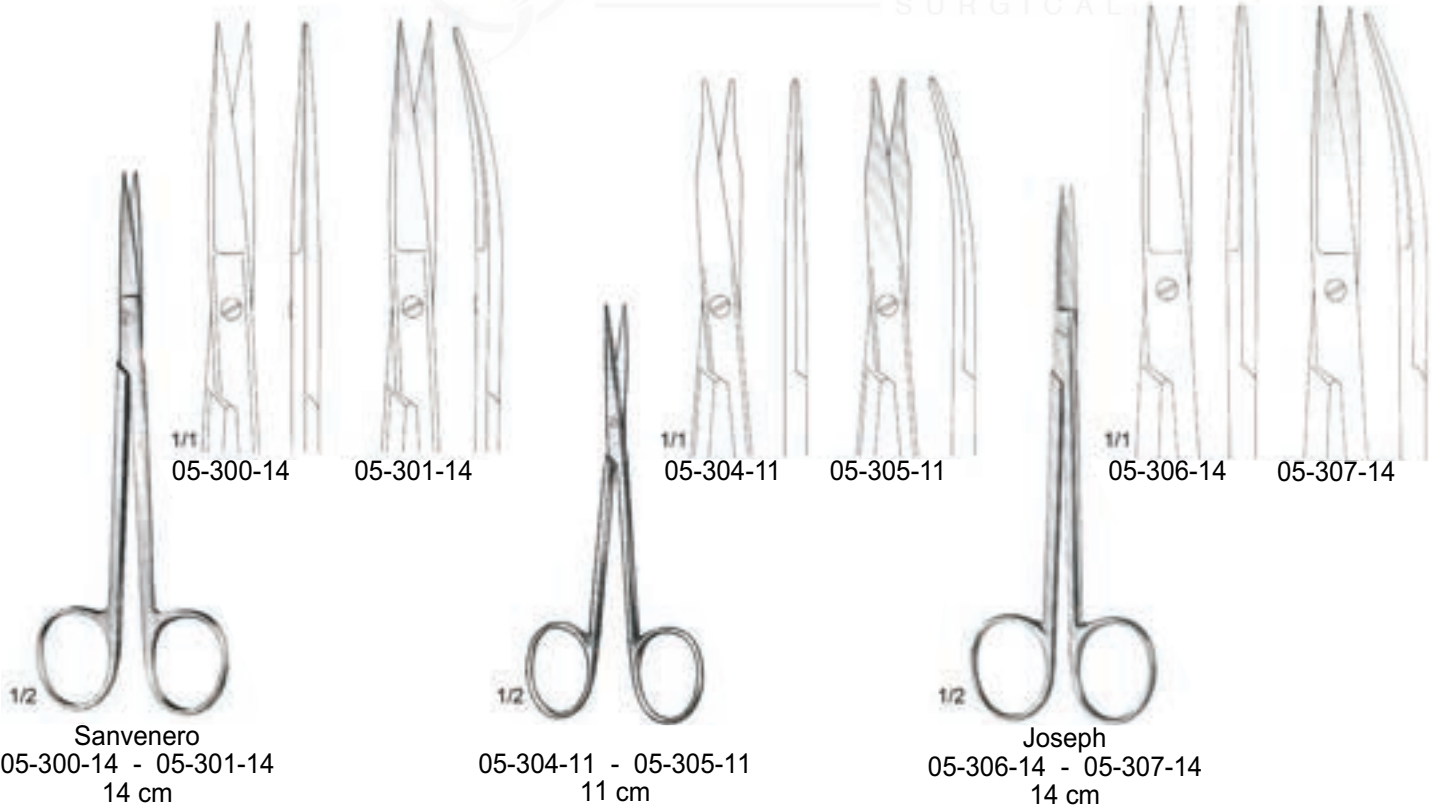



Kilner
 05-311-12 - 05-311-15

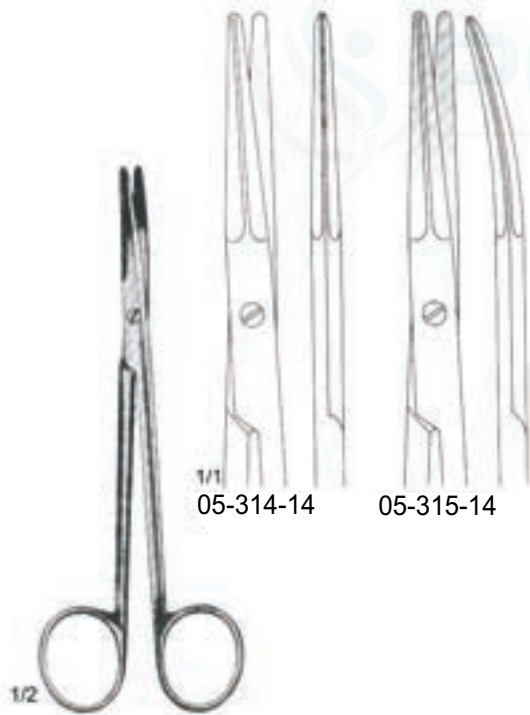

Peck - Joseph
 05-314-14 - 05-315-14
 14.5 cm



Reynolds
 05-316-15 - 05-317-15
 15 cm



Littler
 05-560-11 - 05-561-11
 11.5 cm



Littler
 05-563-11 11.5 cm
 05-563-14 14.0 cm

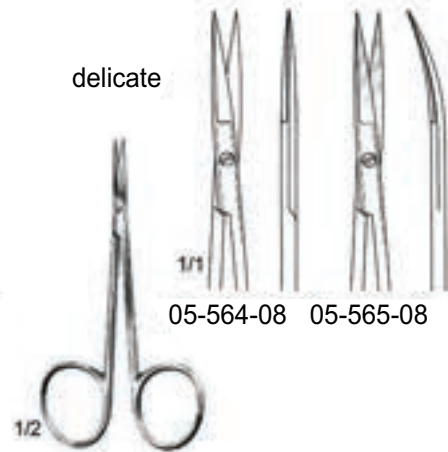

delicate
 05-564-08 - 05-565-08
 8 cm

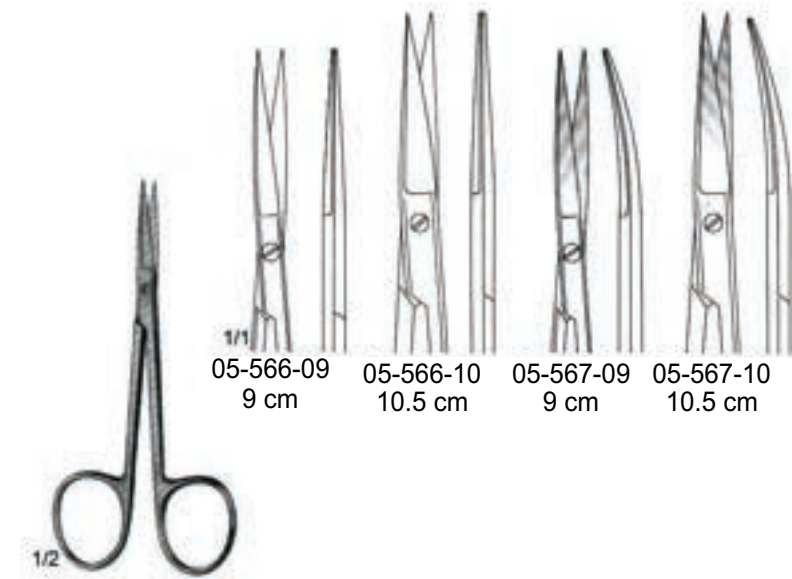

05-566-09 - 05-567-10



extra flat
 05-568-10
 10 cm

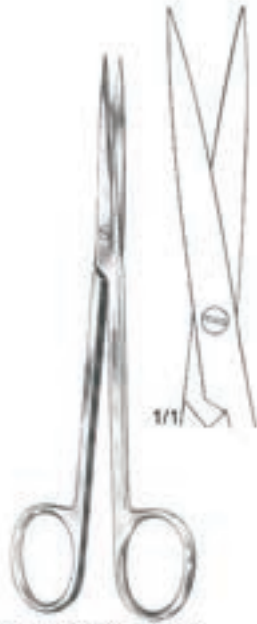

Brophy (Sullivan)
 05-570-14
 14.5 cm



Brophy (Sullivan)
 05-571-14
 14.5 cm

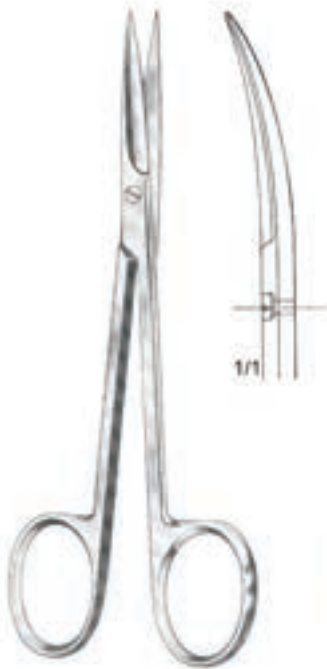

05-572-13
 13 cm



05-574-10 10.5 cm
 05-574-11 11.5 cm



05-575-10 10.5 cm
 05-575-11 11.5 cm



05-578-11
 11.5 cm



Bonn
 05-580-09
 9 cm



Bonn
 05-581-09
 9 cm



Iris
 05-590-09 - 05-591-11



05-590-09	05-591-09	9.0 cm	05-593-11
05-590-10	05-591-10	10.5 cm	11.5 cm
05-590-11	05-591-11	11.5 cm	



05-595-11
 11.5 cm



05-600-12 - 05-601-12
 12 cm



11-600-12



11-601-12

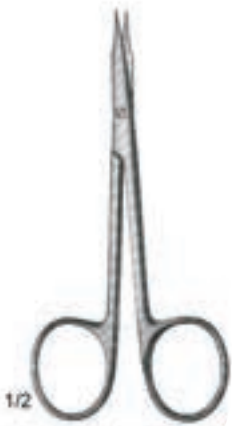

Stevens
 05-610-11 - 05-613-11
 11 cm

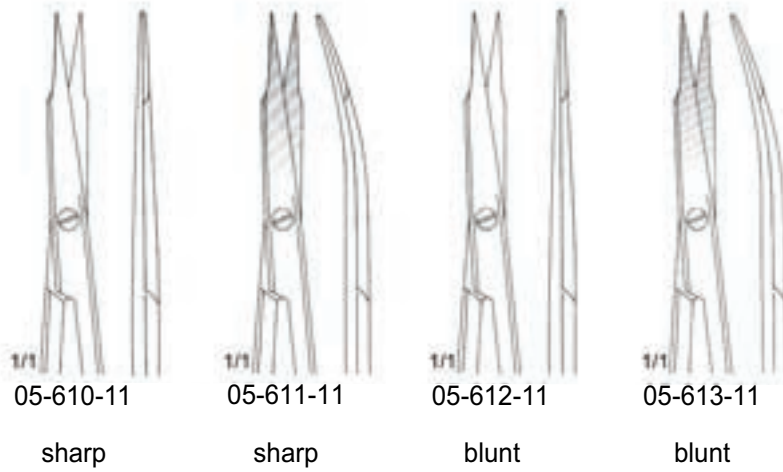

sharp

sharp

blunt

blunt

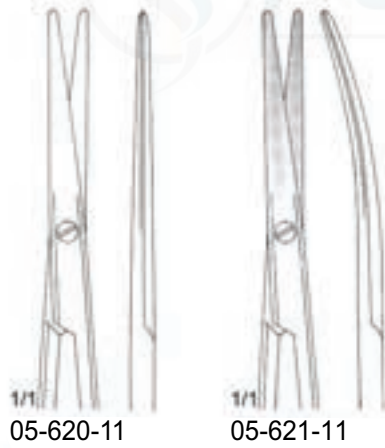

05-620-11

05-621-11



Strabismus
 05-620-11 - 05-621-11
 11.5 cm



Enucleation
 05-625-11
 11.5 cm



O'Brien
 05-681-09
 9 cm

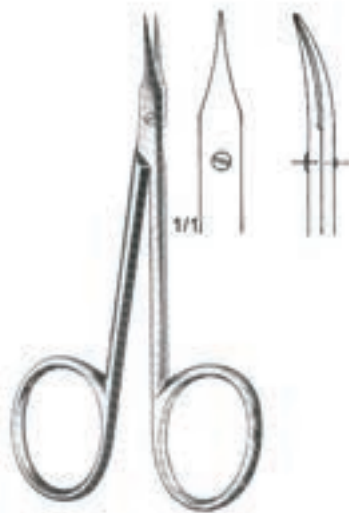

Walton
 05-633-10
 10 cm

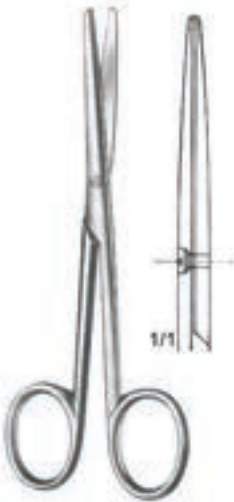

Landolt
 05-636-12
 12.5 cm

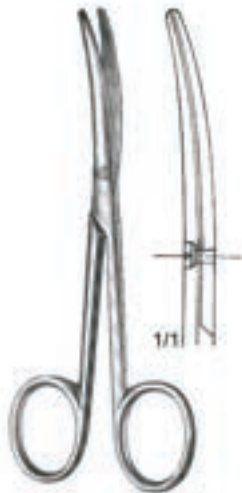

Landolt
 05-637-12
 12.5 cm

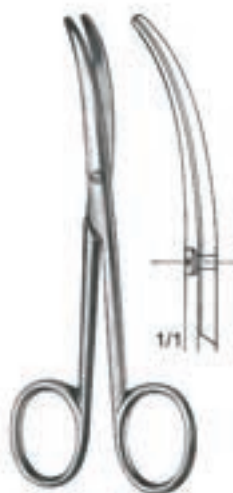

Landolt
 05-638-12
 12.5 cm



Landolt
 05-639-12
 12.5 cm

straight



curved

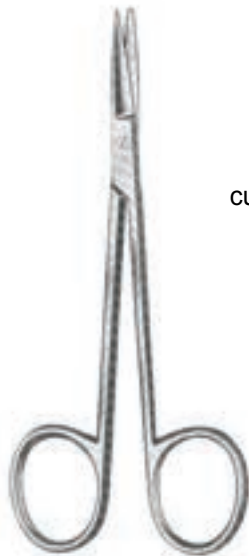

05-640-01 - 05-641-02
11.5 cm



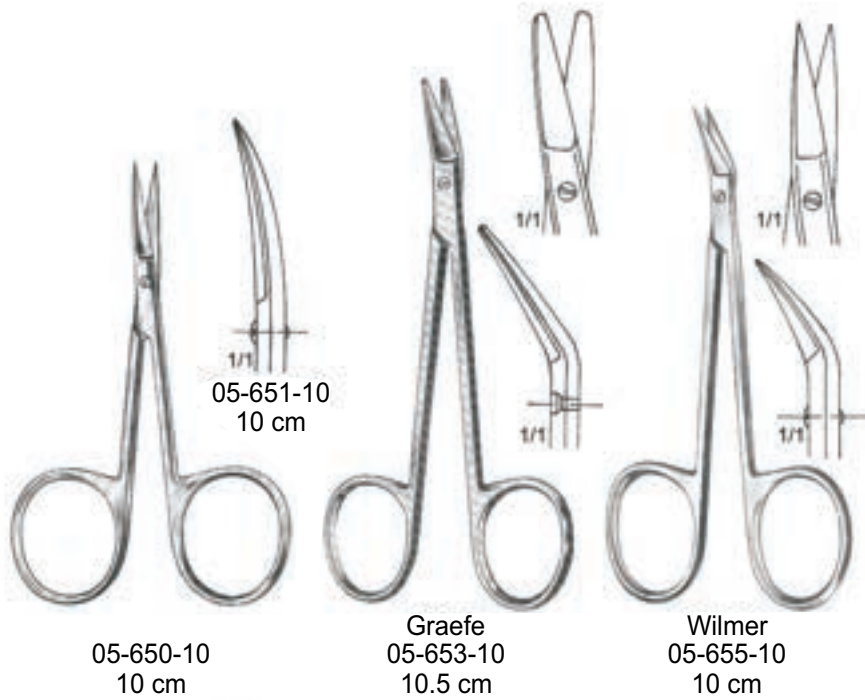



05-660-10 straight
05-661-10 curved
10 cm

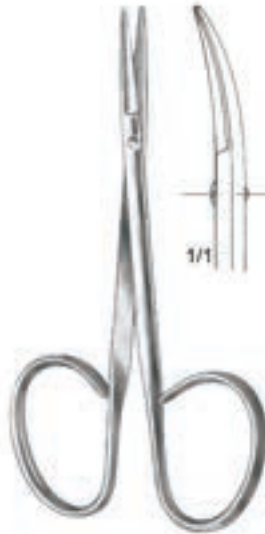

05-662-10 straight
05-663-10 curved
10 cm



05-664-10 straight
05-665-10 curved
10 cm

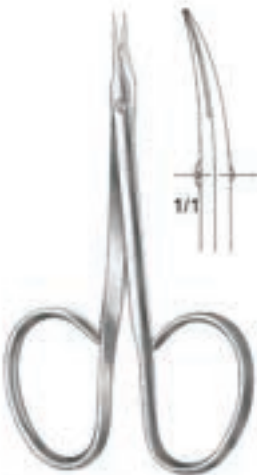

05-670-10 straight
05-671-10 curved
9.5 cm

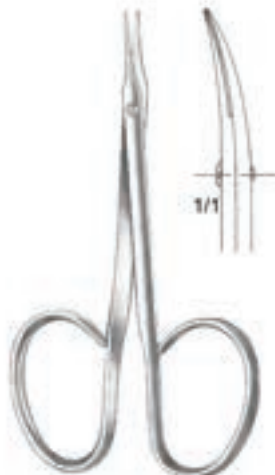

05-672-10 straight
05-673-10 curved
9.5 cm

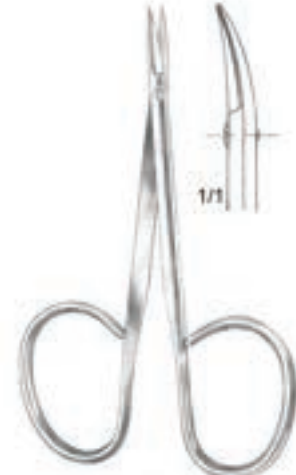

05-674-10 straight
05-675-10 curved
9.5 cm



05-680-12
 05-682-12
 05-684-12

Fig. 1



Fig. 2



Fig. 3



Noyes
 12 cm
 Fig. 1
 Fig. 2
 Fig. 3



05-681-12
 05-683-12
 05-685-12

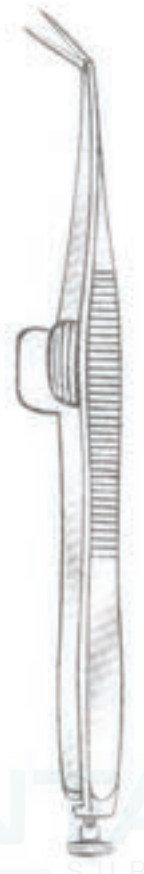

Wecker
 11 cm



05-690-11



05-692-11



05-694-11



Barraquer
 5.5 cm

5 mm 05-698-05
 7 mm 05-698-07
 10 mm 05-698-10



Castroviejo
 05-700-00
 9 cm



05-700-02



05-700-03



05-701-09



05-702-09



Castroviejo
 05-703-10
 10 cm

pointed



Castroviejo
 05-705-10
 10 cm

blunt

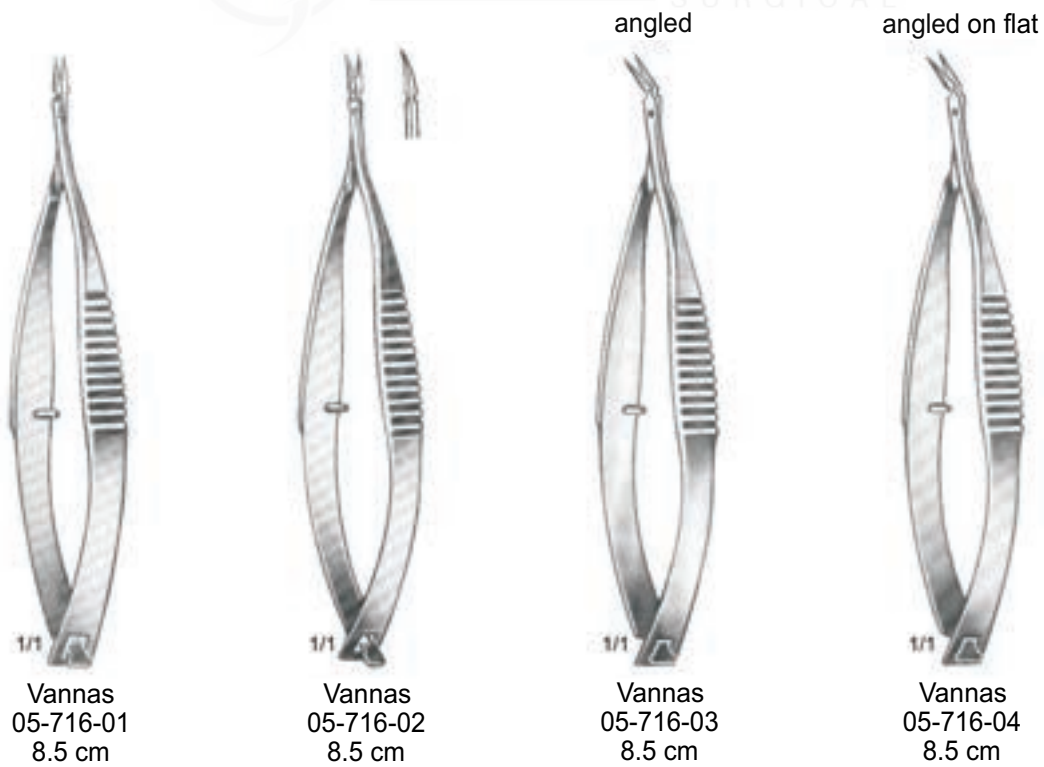
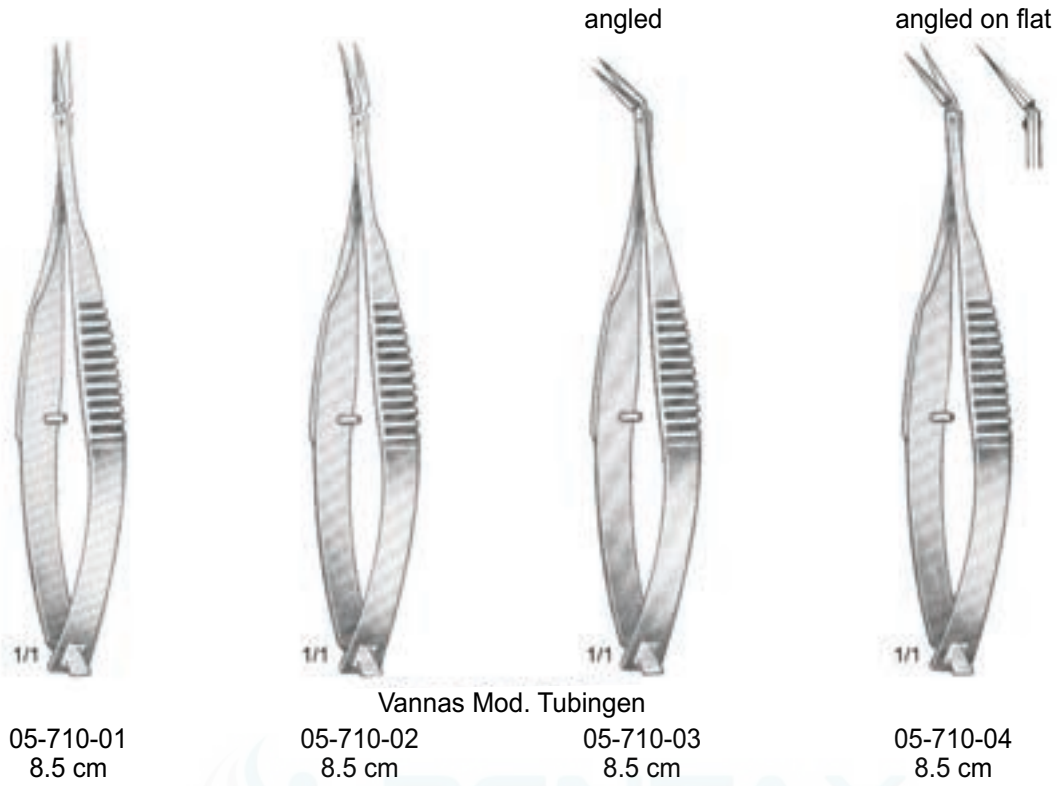



Westcott
 05-720-11
 11 cm



Westcott
 05-722-11
 11 cm



Castroviejo
 05-725-01
 10 cm



Castroviejo
 05-725-02
 10 cm



Castroviejo
 05-726-01
 11 cm



Castroviejo
 05-726-02
 11 cm



Troutman
 05-728-01
 10 cm



Troutman
 05-728-02
 10 cm



Katzin
05-730-01
10 cm



Katzin
05-730-02
10 cm



Katzin
05-731-01
11 cm



Katzin
05-731-02
11 cm



05-732-01
10 cm



05-732-02
10 cm



05-733-00
10 cm



05-738-01
10 cm

Katzin - Barraquer



05-734-12
12 cm



Noyes
05-735-15
15 cm



Martin - Cartilage
05-740-20
20 cm

Mc Indoe
05-741-19
19 cm

Potts - Smith
05-743-19
19 cm

Craford
05-745-30
30 cm

Finochietto
05-747-27
27 cm



05-750-21
21 cm

05-752-21
21 cm

05-754-21
21 cm



05-758-11 11 cm
05-758-13 13 cm
05-758-14 14 cm

05-759-11
05-759-13
05-759-14



1/2
Graefe
06-502-10 - 06-515-10
10.5 cm



06-502-10



06-503-10



06-505-10



06-512-10
1:2 Teeth



06-513-10
1:2 Teeth



06-515-10
1:2 Teeth



8.0 cm 06-520-08
 9.0 cm 06-520-09
 10.5 cm 06-520-10
 11.5 cm 06-520-11
 12.5 cm 06-520-12
 14.5 cm 06-520-14

without pin

06-521-08
 06-521-09
 06-521-10
 06-521-11
 06-521-12
 06-521-14

without pin

06-524-08
 06-524-09
 06-524-10
 06-524-11
 06-524-12
 06-521-14

without pin

06-525-08
 06-525-09
 06-525-10
 06-525-11
 06-525-12
 06-525-14

without pin

8.0 cm 06-530-08
 9.0 cm 06-530-09
 10.5 cm 06-530-10
 11.5 cm 06-530-11
 12.5 cm 06-530-12
 14.5 cm 06-530-14

with pin

06-531-08
 06-531-09
 06-531-10
 06-531-11
 06-531-12
 06-531-14

with pin

06-534-08
 06-534-09
 06-534-10
 06-534-11
 06-534-12
 06-534-14

with pin

06-535-08
 06-535-09
 06-535-10
 06-535-11
 06-535-12
 06-535-14

with pin

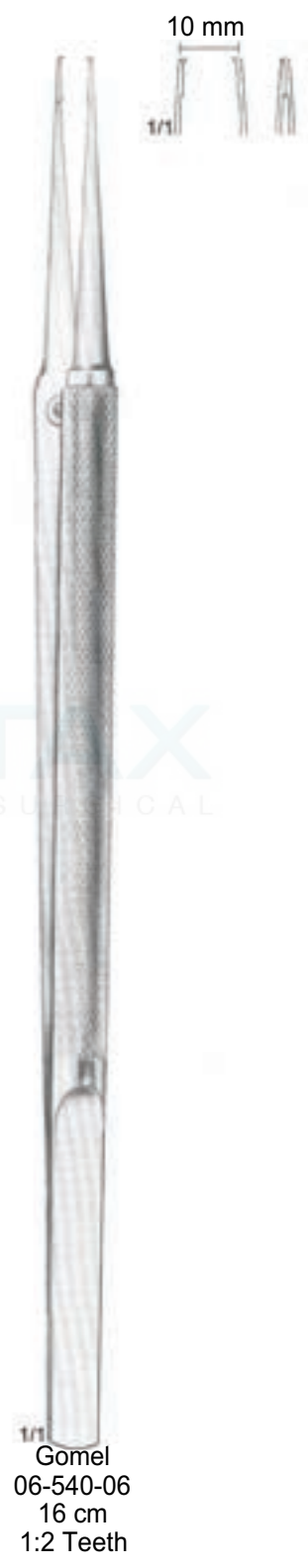





06-570-12
12.5 cm



06-574-10
10 cm



06-576-10
10 cm



06-578-07
7.5 cm



06-578-09
9 cm



06-578-11
11.5 cm

Feilchenfeld

06-578-07 - 06-578-11



Hunter
06-580-10 - 06-581-10
10.5 cm

06-580-10



06-581-10



Walter - Carmalt
06-584-10
10.5 cm



Walter - Carmalt
06-585-10
10.5 cm



06-588-10
10.5 cm



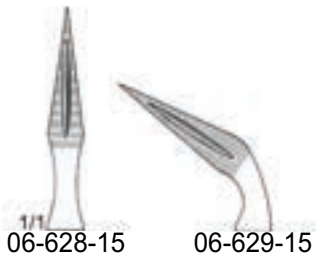
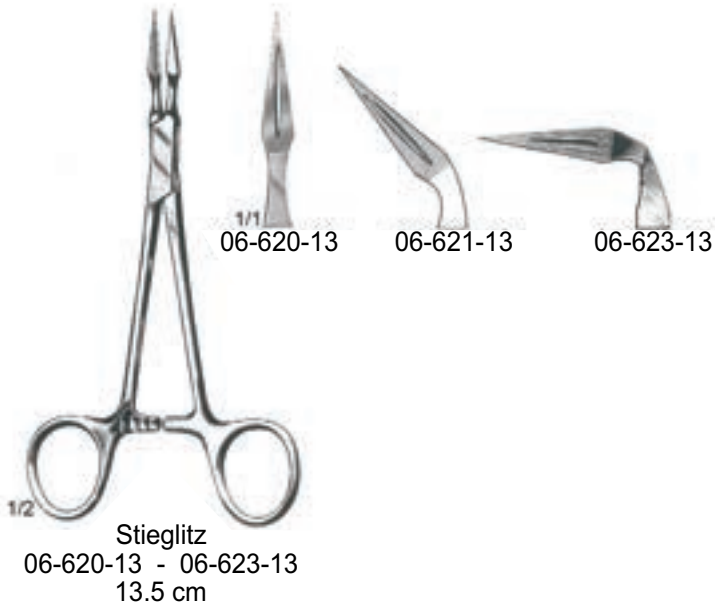



07, 11



Dieffenbach

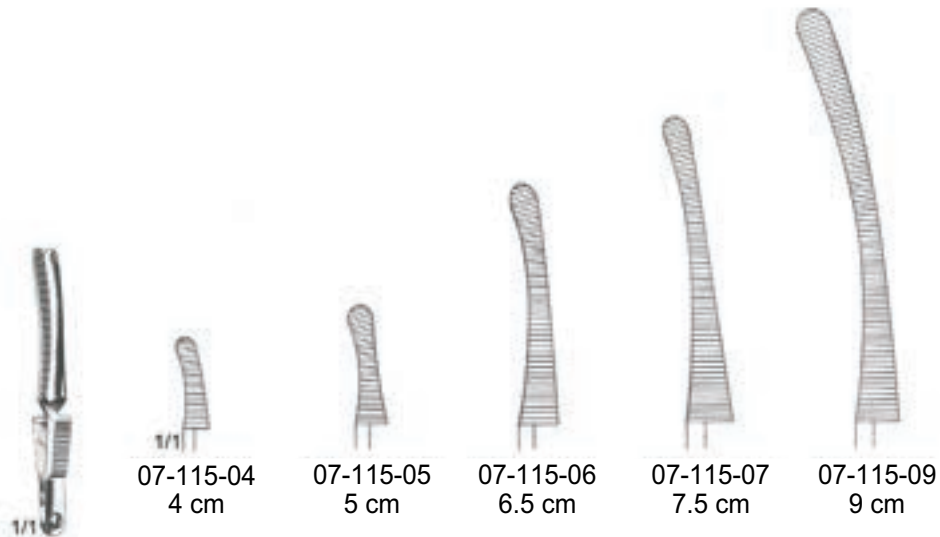
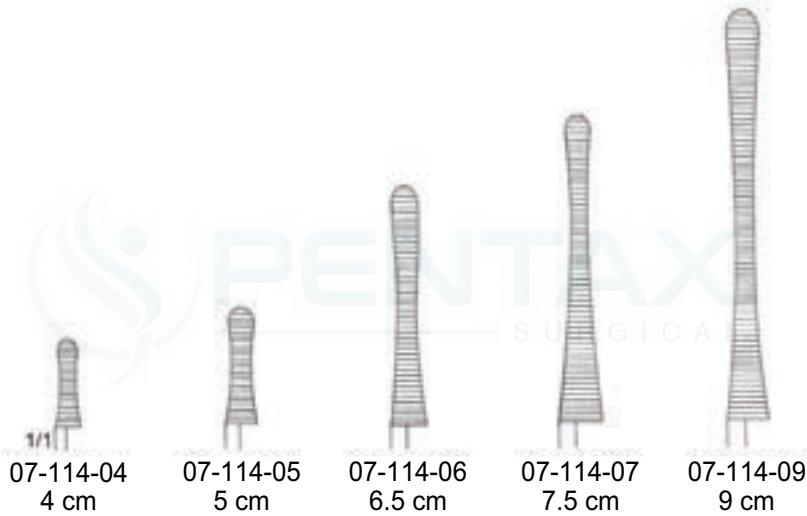

Johns Hopkins



Baby - Mixer
07-181-01 - 07-181-02
14 cm

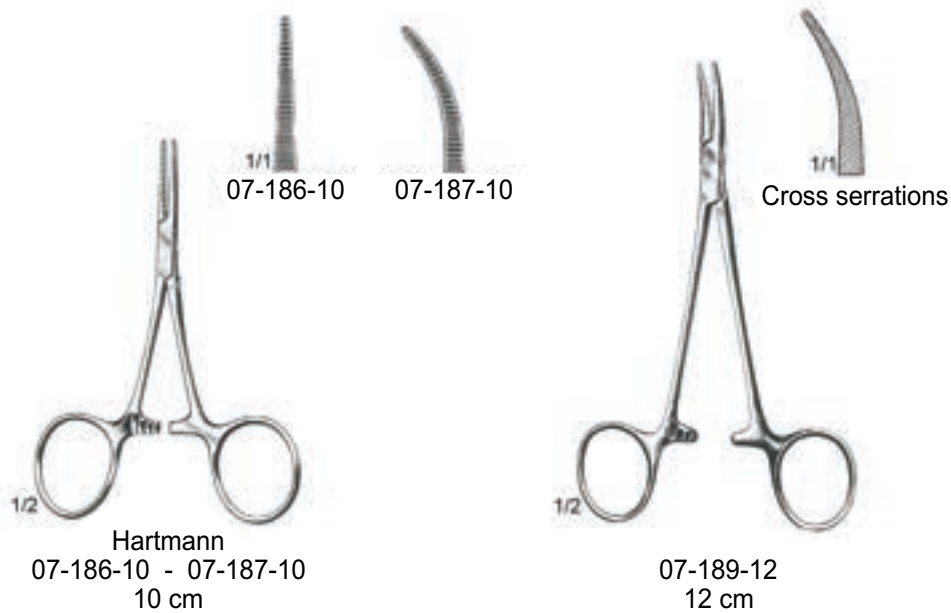

Hartmann
07-186-10 - 07-187-10
10 cm

07-189-12
12 cm



Halsted - Mosquito
 07-190-12 - 07-193-14

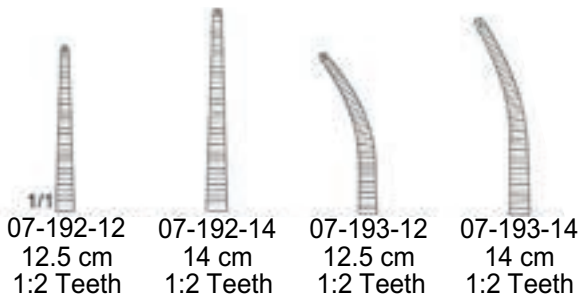
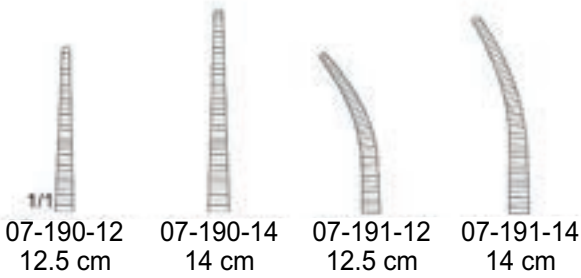

Micro - Mosquito
 07-210-10 - 07-213-12

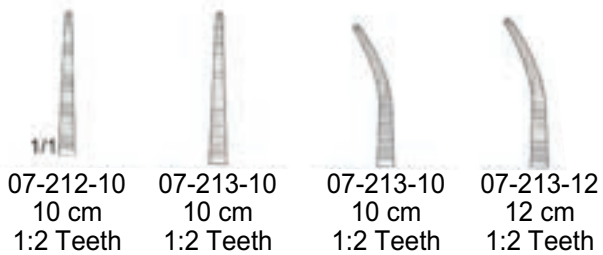
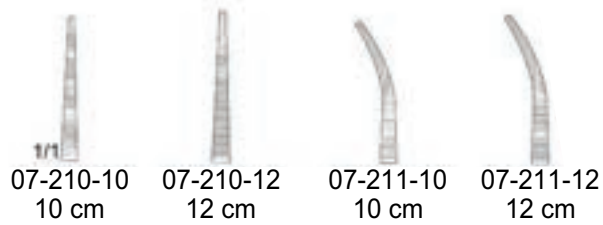



1/2
Schaedel
07-671-09
9 cm



Jones
07-673-05 5 cm
07-673-09 9 cm



1/2
Jones-Martin
07-675-09
9 cm
with clip

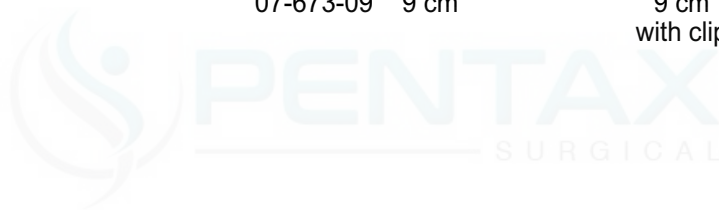

Backhaus
07-681-11 11 cm
07-681-13 13 cm

delicate pattern



1/2
Backhaus
07-683-11
11 cm

with clip



1/1
Backhaus
07-685-08 8 cm
07-685-11 11 cm
07-685-13 13 cm
07-685-15 15 cm



Roeder
07-687-13 13 cm
07-687-15 15 cm



Lorna
 07-691-10 10 cm
 07-591-13 13 cm



Lane
 07-695-20
 20 cm



Tohoku
 07-697-10 10 cm
 07-697-13 13 cm

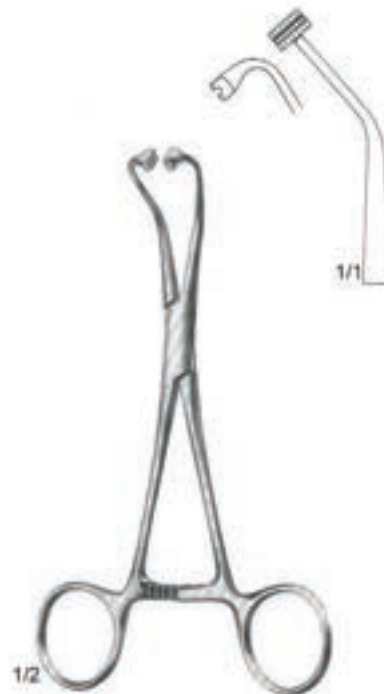

Peers - Bertram
 07-699-14
 14.5 cm



Engl. Modell
07-703-09
9 cm



Doyen
07-705-11
11 cm



Doyen
07-707-18
18 cm



Bernhard
07-713-16
16.5 cm



Barraquer - Troutman
 11-100-10
 10 cm



Barraquer - Troutman
 11-101-10
 10 cm



Barraquer - Troutman
 11-102-10
 10 cm



Barraquer - Troutman
 11-103-10
 10 cm



Barraquer
 11-105-11
 11 cm



Barraquer
 11-105-13
 13 cm



Barraquer
 11-105-14
 14 cm



Barraquer
 11-106-14
 14 cm



Barraquer
 11-107-14
 14 cm



Troutman
 11-109-01
 12 cm



Troutman
 11-109-02
 12 cm



Reill
 11-110-15 - 11-111-15
 15 cm



11-110-15



11-111-15



Reill
 11-112-15 - 11-113-15
 15 cm



11-112-15



11-113-15

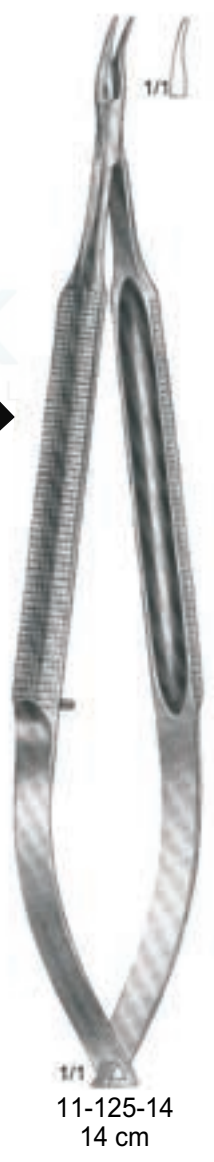

◀ Jaws concave/convex ▶

for right handed surgeons

for left handed surgeons



11-130-18
 18 cm



11-131-18
 18 cm

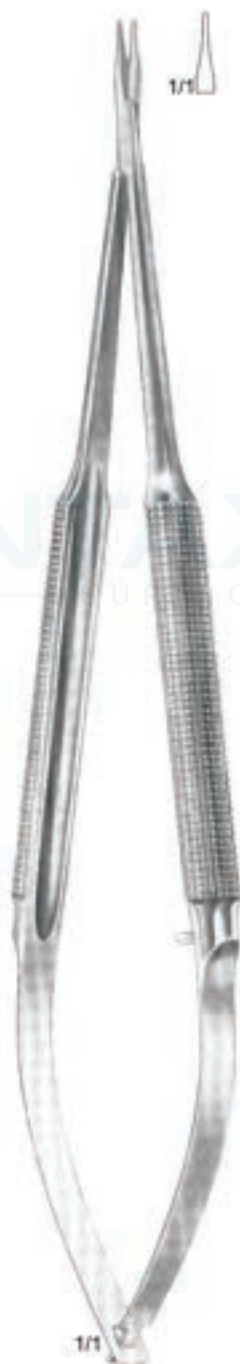

11-132-18
 18 cm

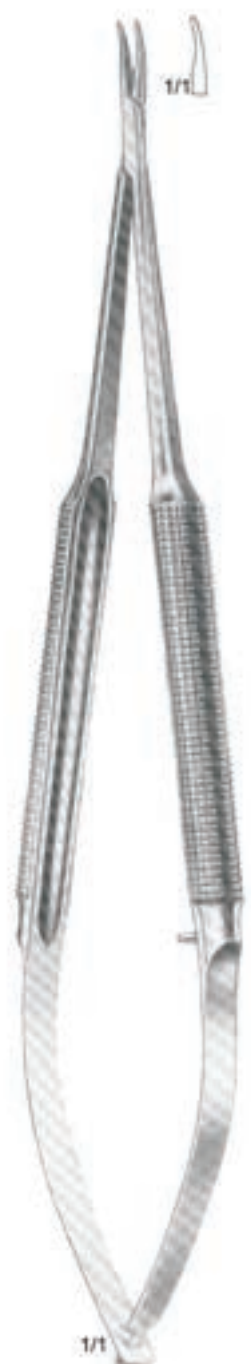

11-133-18
 18 cm



Gomel
 11-141-01 - 11-141-03
 16 cm



11-141-01



11-141-02



11-141-03

for right hand Jaws concave/convex for left hand Jaws concave/convex



Gomel
 11-145-14 - 11-149-14
 14 cm



11-145-14



11-147-14



11-149-14

for right hand Jaws concave/convex for left hand Jaws concave/convex

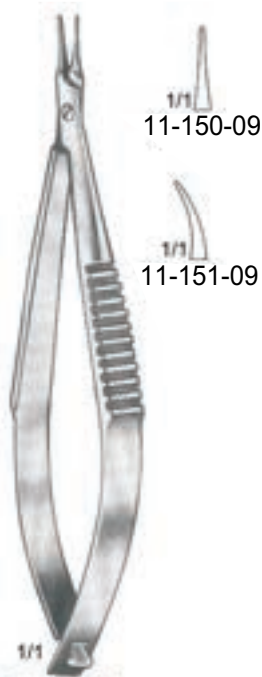

11-150-09

11-151-09

Castroviejo
 11-150-09 - 11-151-09
 19 cm



11-152-09

11-153-09

Castroviejo
 11-152-09 - 11-153-09
 19 cm

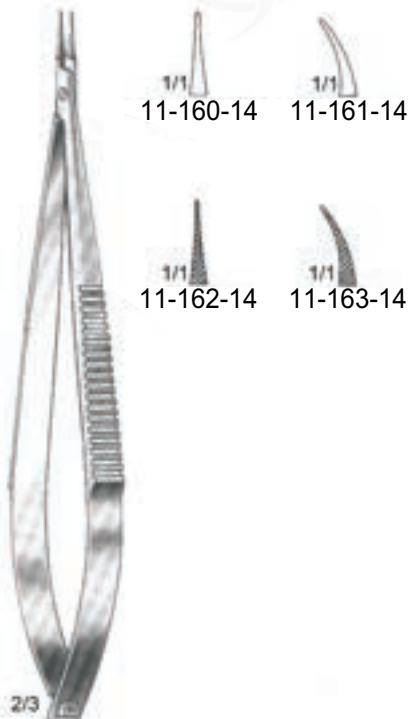

11-160-14

11-161-14

11-162-14

11-163-14

Castroviejo
 11-160-14 - 11-160-14
 14 cm

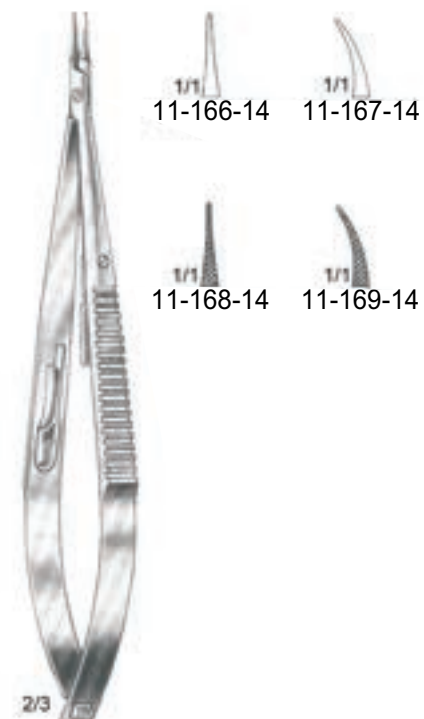

11-166-14

11-167-14

11-168-14

11-169-14

Castroviejo
 11-166-14 - 11-169-14
 14 cm



11-170-14 11-171-14

wide handle

Castroviejo
 11-170-14 - 11-171-14
 14 cm



11-172-14 11-173-14

Castroviejo
 11-172-14 - 11-173-14
 14 cm



11-178-18
 18 cm 11-178-21
 21 cm

Jacobson
 11-178-18 - 11-178-21



Castroviejo - Fine
11-180-01
13 cm



Castroviejo - Fine
11-181-01
13 cm



Castroviejo - Fine
11-182-01
13 cm



Castroviejo - Fine
11-183-01
13 cm



11-190-16
 11-190-18
 11-190-20
 11-190-22

16.5 cm
 18.0 cm
 20.0 cm
 22.0 cm



11-191-16
 11-191-18
 11-191-20
 11-191-22

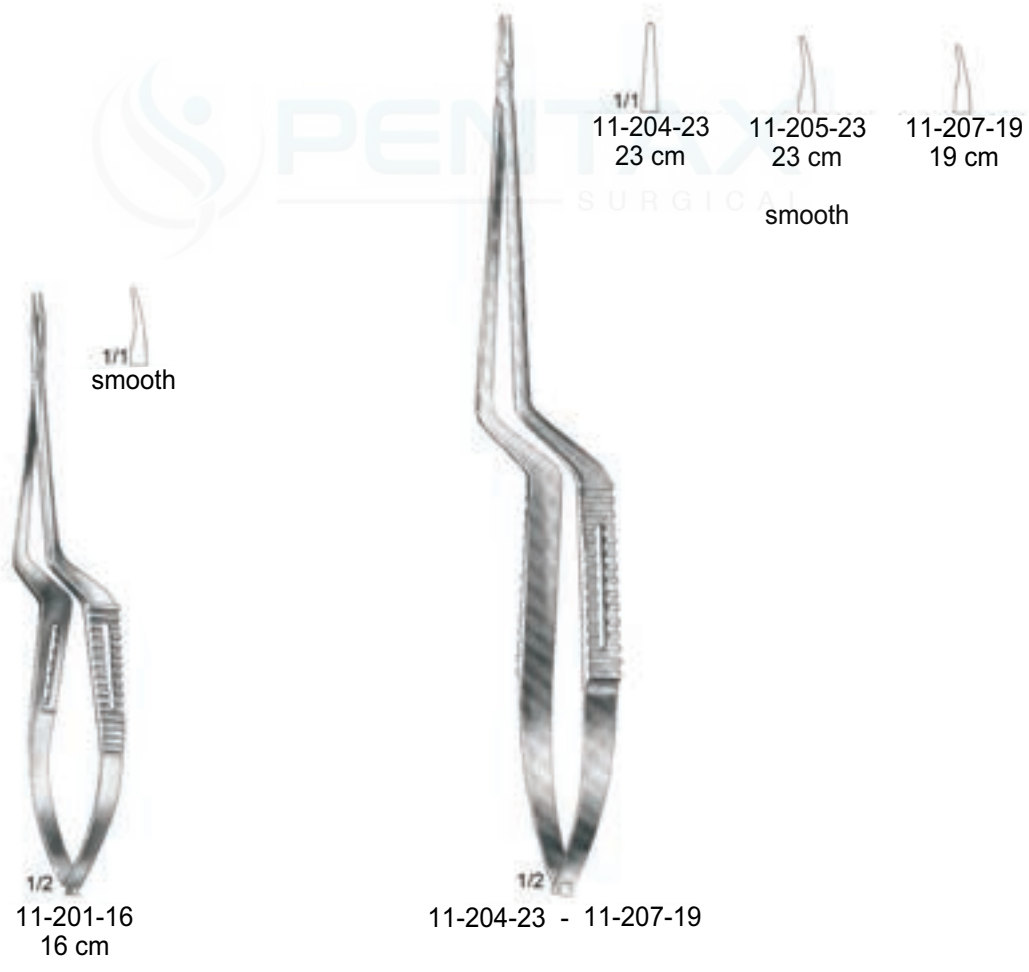



Paton
 11-210-11
 11 cm



Paton
 11-211-11
 11 cm



Arruga
 11-212-14 - 11-213-14
 14 cm



Kalt
 11-214-14
 14 cm



Kalt - Arruga
 11-215-14
 14 cm



Castroviejo - Kalt
 11-216-13
 13 cm



Stevens
 11-218-13 13 cm
 11-218-15 15 cm



Potts - Smith
 11-220-22
 22 cm



Barraquer
 11-222-14
 14 cm



Arruga
 11-224-16 - 11-225-16
 16 cm



Castroviejo - Barraquer
 11-227-12
 12 cm

Handle Ø 8 mm

Handle Ø 8 mm

Handle Ø 10 mm

Handle Ø 10 mm



Castroviejo
 11-230-13 - 11-231-13
 13 cm



Castroviejo
 11-232-13 - 11-233-13
 13 cm



Castroviejo
 11-234-13 - 11-235-13
 13 cm

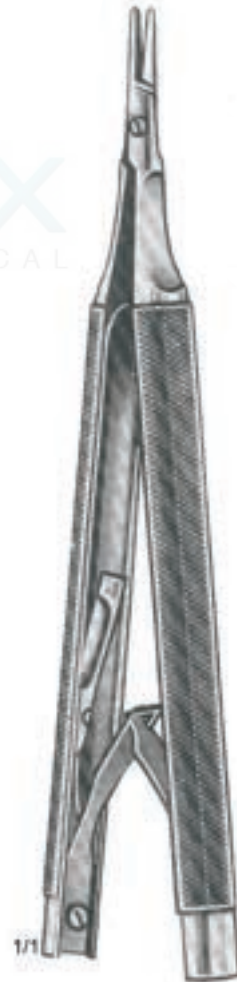

Castroviejo
 11-236-13 - 11-237-13
 13 cm





Dietrich
 11-510-16 - 11-510-26



Micro profile



Castroviejo
 11-514-14 - 11-515-21



smooth Micro profile Micro profile



smooth Micro profile Micro profile



Barraquer
 11-520-13
 13 cm



Barraquer
 11-522-13
 13 cm

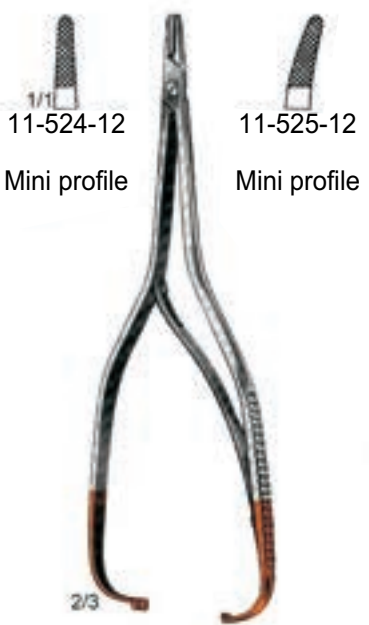

Boynton
 11-524-12 - 11-525-12
 12 cm

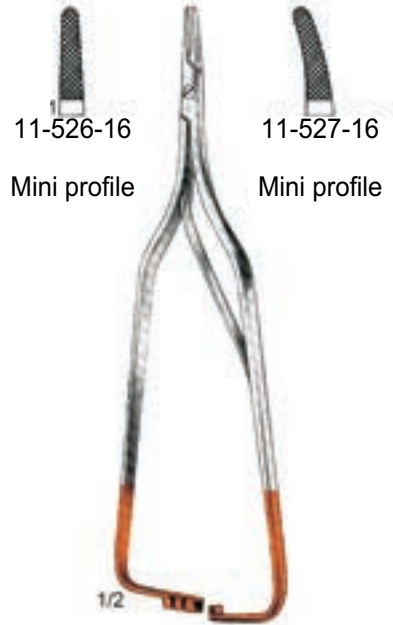

Arruga
 11-526-16 - 11-527-16
 16 cm



Kalt
 11-530-14
 14 cm



Castroviejo
 11-532-13
 13 cm



Jacobson
 11-534-01 - 11-534-02
 21 cm



Potts - Smith
 11-536-22
 22 cm



26

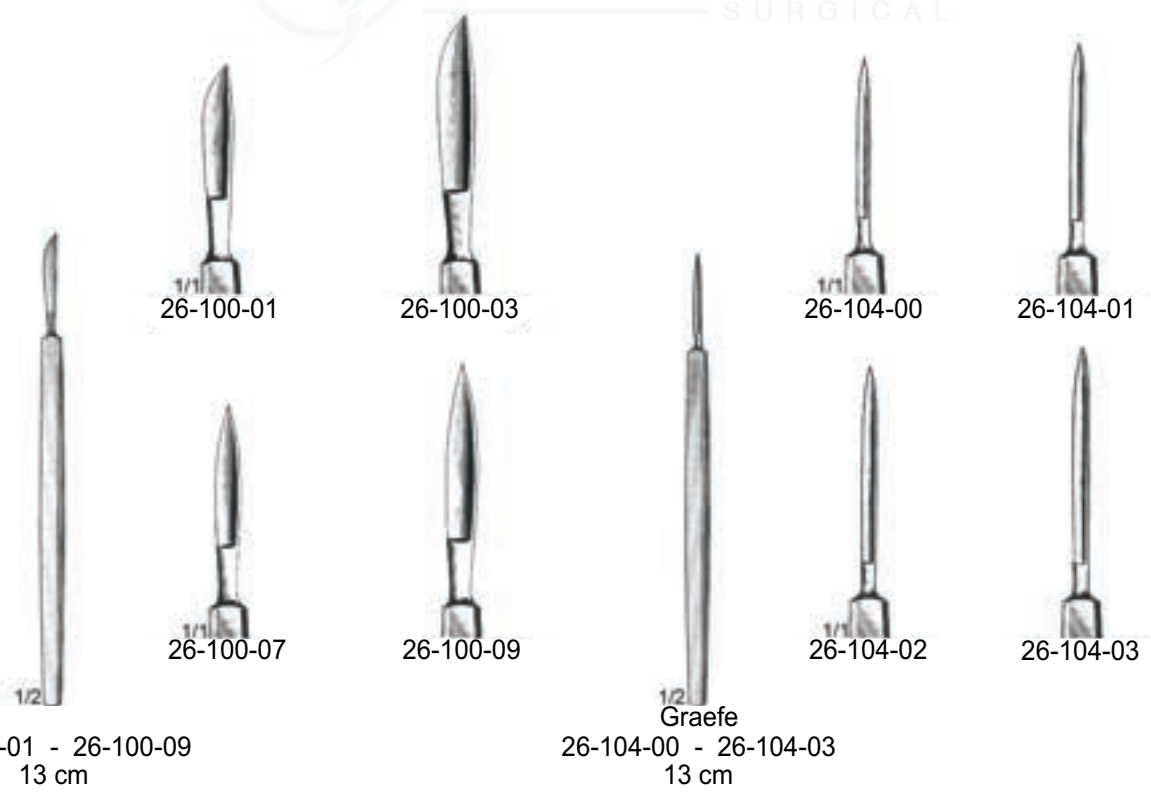



26-108-00



26-112-01



1/2
 Graefe
 26-108-00 - 26-108-02
 13 cm



1/1
 26-108-01



26-108-02



1/2
 Graefe - Arruga
 26-112-01 - 26-112-03
 13 cm



1/1
 26-112-02



26-112-03

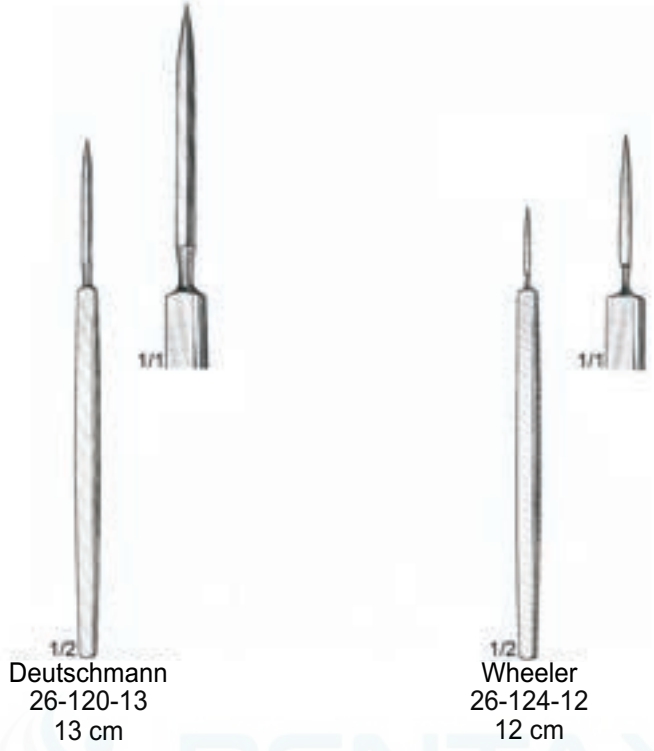

Deutschmann
26-120-13
13 cm

Wheeler
26-124-12
12 cm

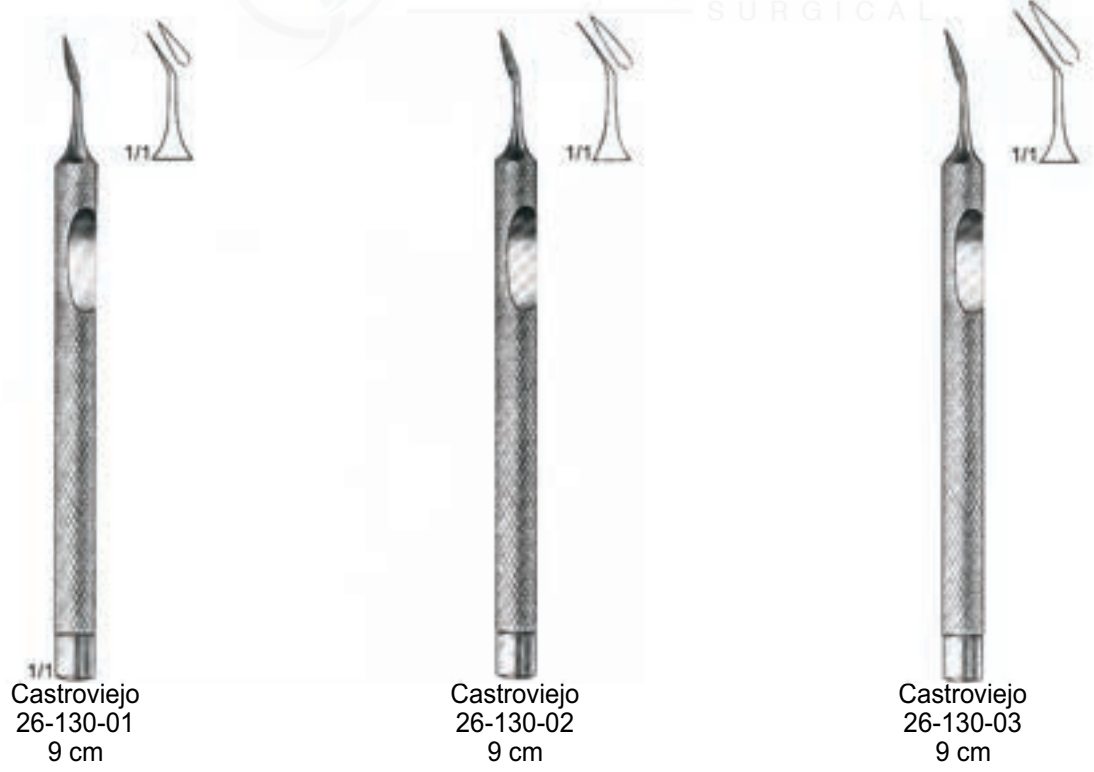

Castroviejo
26-130-01
9 cm

Castroviejo
26-130-02
9 cm

Castroviejo
26-130-03
9 cm

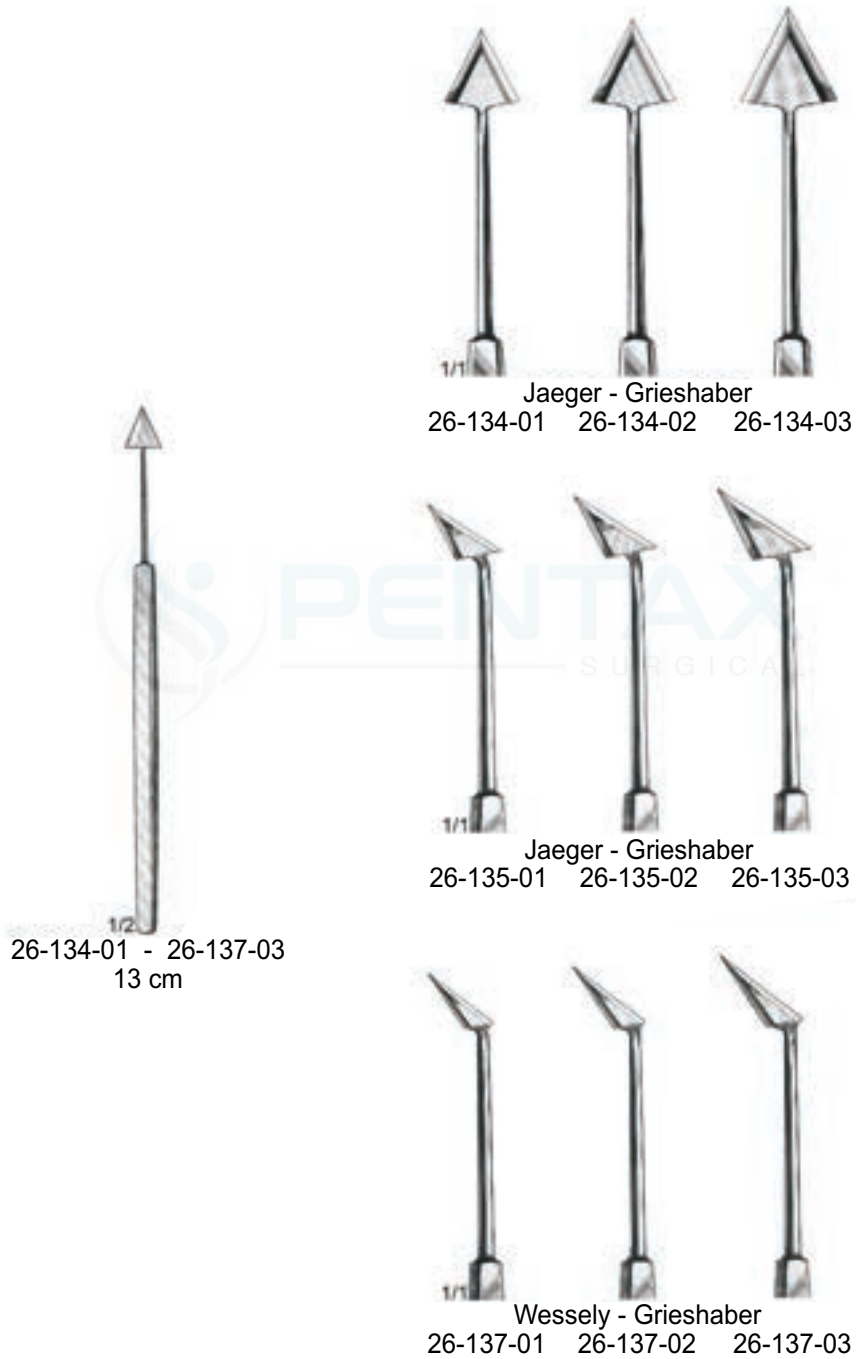





Bowman
26-155-11



Bowman
26-155-12



Knapp
26-158-01



Knapp
26-158-02



Knapp
26-158-03



Ziegler
26-160-01
5 mm



Ziegler
26-160-02
6 mm



Ziegler
26-160-03
7 mm



Ziegler
26-164-11
3.5 mm



Sato
26-171-12
12.5 cm



Dean
26-173-12
12.5 cm



Sichel
26-176-13
13 cm



Kuhnt
26-178-01



Kuhnt
26-178-02



Kuhnt
26-178-03



Kuhnt
26-178-04

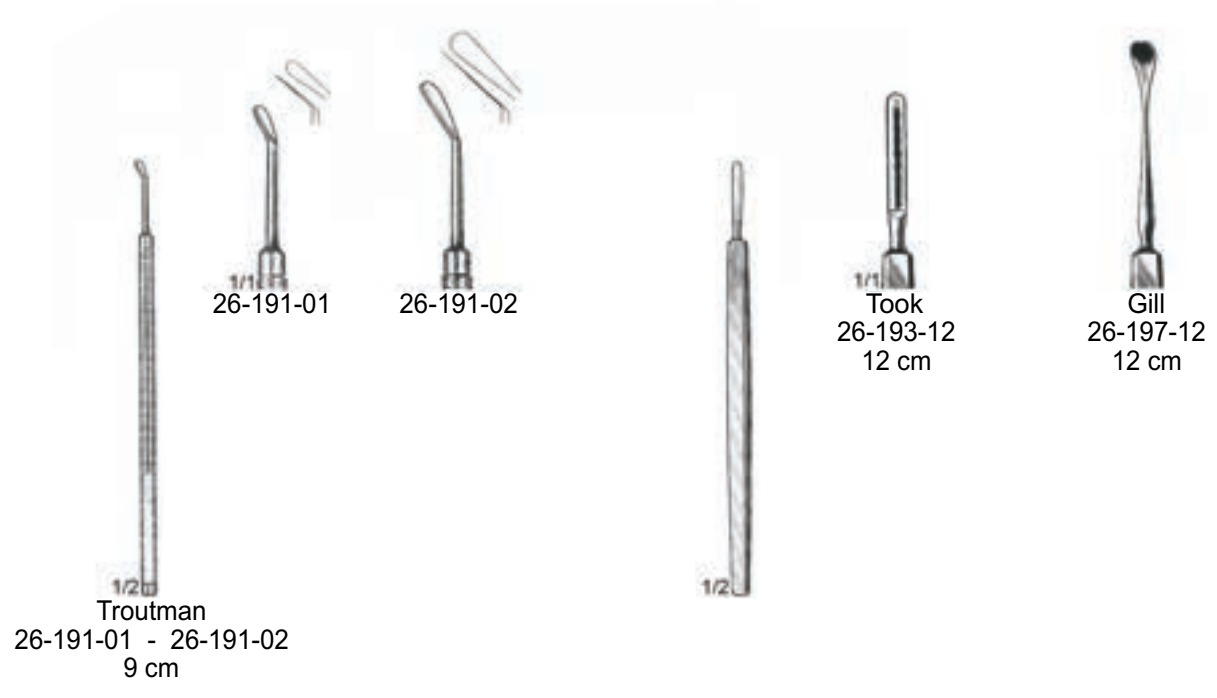
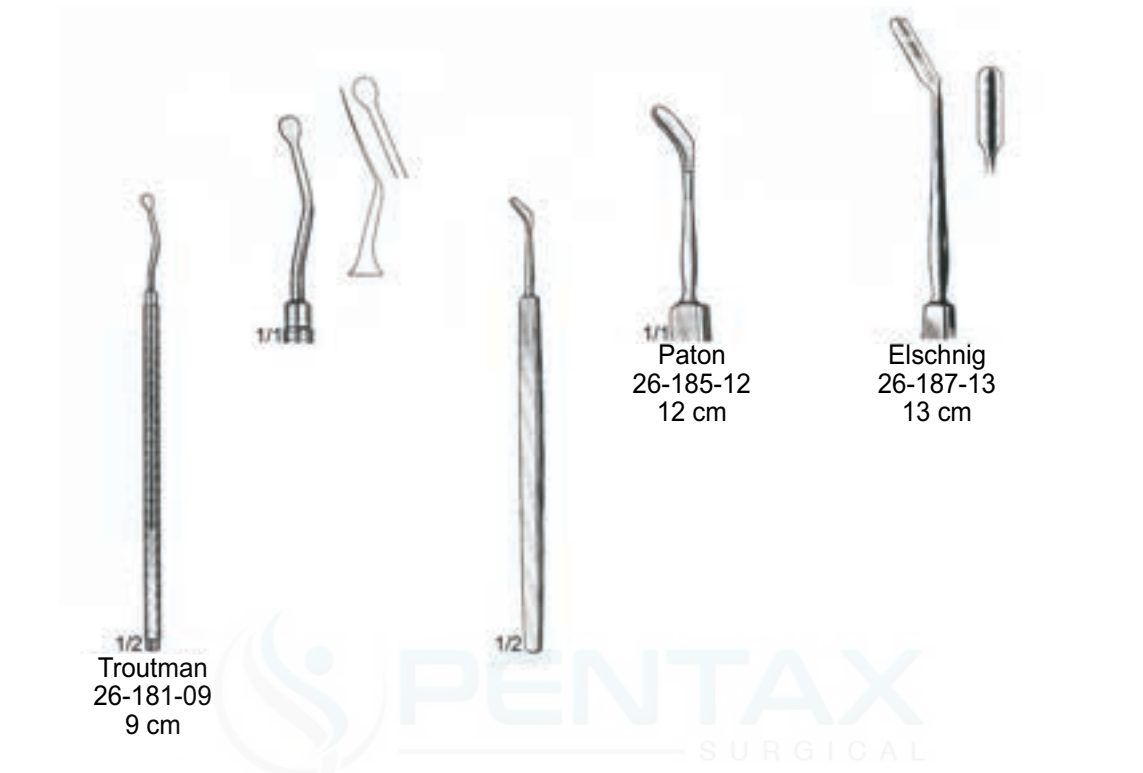



Anderson - Critchett
26-201-13



Lundsgaard
26-203-12



Guyton - Lundsgaard
26-205-12



Barkan
26-208-12



Scheie
26-210-13



1/2



Burch
26-212-13



26-214-12



26-215-12



26-218-12



26-219-12



Bowman
26-220-12



Bowman
26-221-12



Schweiz Mod.
26-224-12



26-226-13



26-227-13



Levinson
26-228-13



Alvis
26-230-12



Francis
26-233-12



La Force
26-235-12



Davis
26-237-13



Dix
26-238-13



Ellis
26-241-11



Plange
26-243-12



Nicati
26-244-12



Walton
26-246-12



Walton
26-248-12



Meyer
26-250-12



Green
26-252-13



Rollet
26-254-12



Standard
26-260-12



Standard
26-262-12



26-266-11



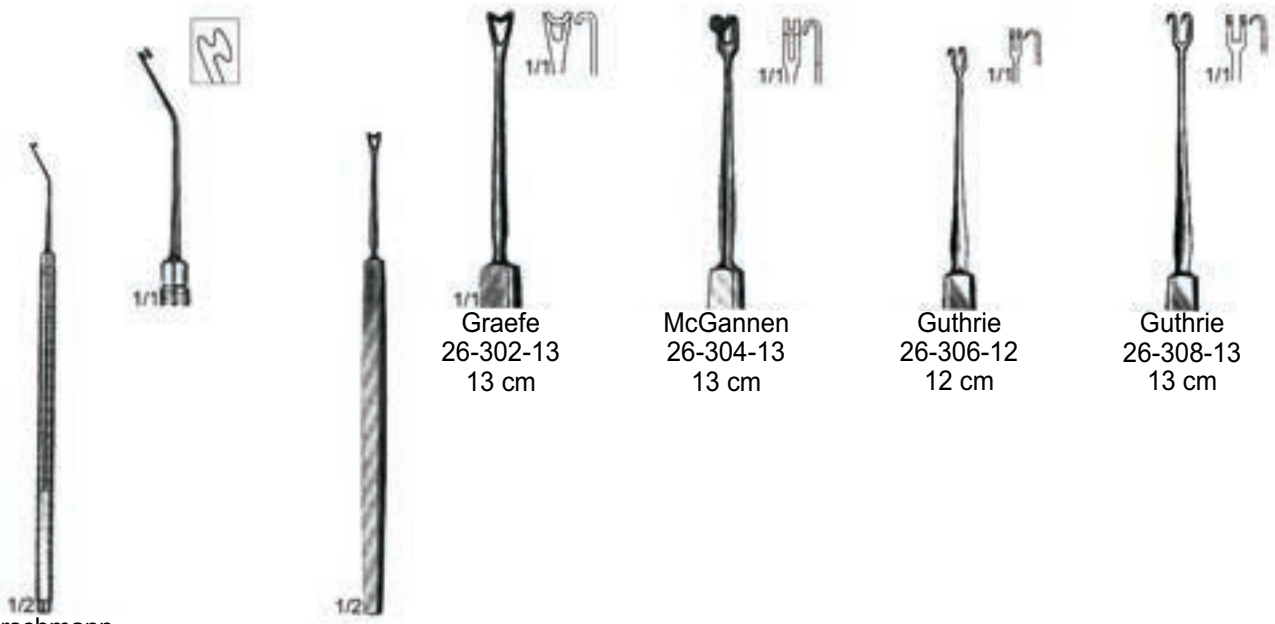

Hirschmann
 26-301-13
 13 cm

Graefe
 26-302-13
 13 cm

McGannen
 26-304-13
 13 cm

Guthrie
 26-306-12
 12 cm

Guthrie
 26-308-13
 13 cm



Knapp
 26-310-13

Fink
 26-314-13

26-318-10
 right

26-319-10
 left

26-318-10 - 26-319-10
 10.5 cm

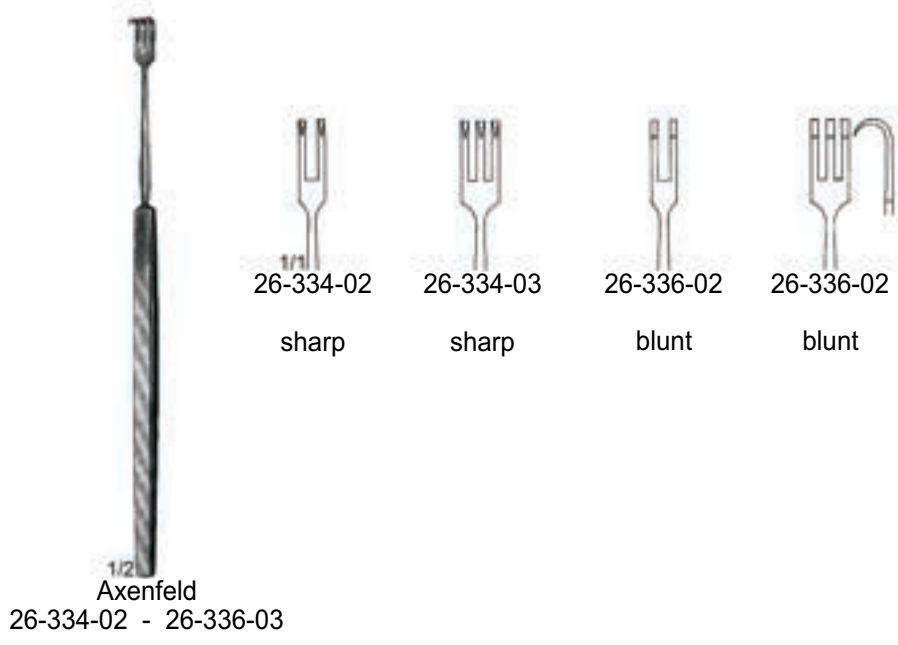
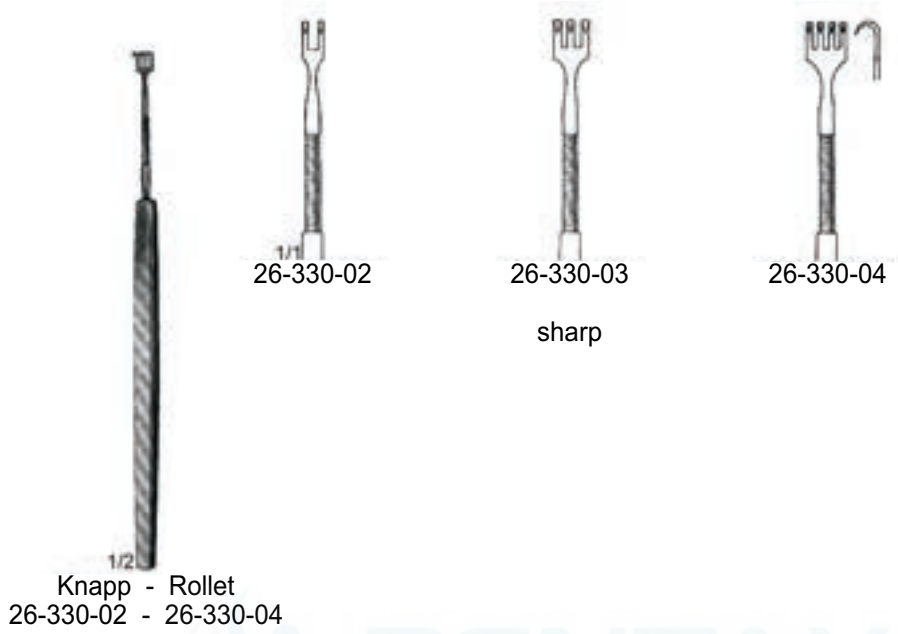

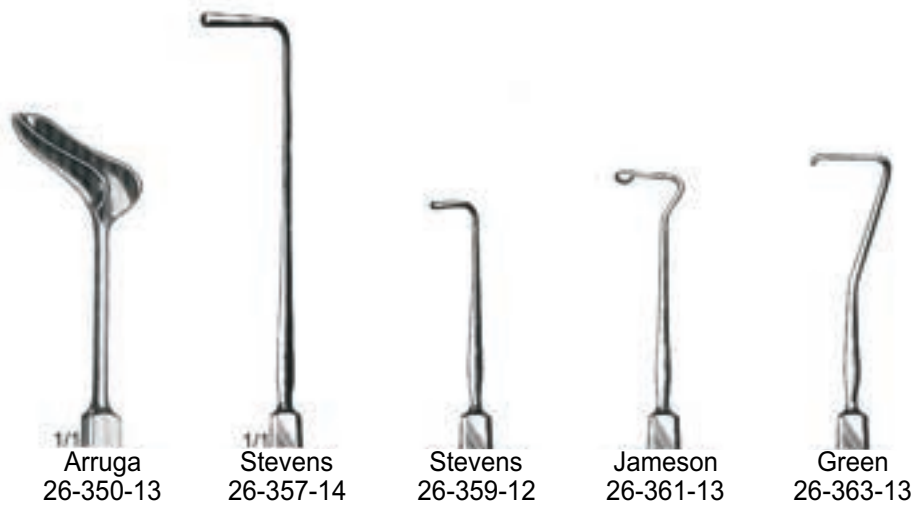





Barraquer (Colibri)
 26-430-03 3 cm children
 26-430-04 4 cm adults



Mod. Barraquer
 26-432-04
 4 cm



Bowman
 26-436-07
 7 cm

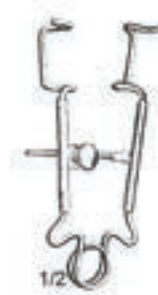

Critchett
 26-438-07
 7 cm



Graefe
 26-440-07 7 cm children
 26-440-09 9 cm adults



Pley
 26-442-06
 6 cm



Ziegler
 26-446-07
 7 cm



Knapp - Clark
 26-448-08
 8 cm



Lancaster
 26-450-08
 8 cm



Weiss
 26-452-07 7 cm children
 26-452-09 9 cm adults



Weiss
 26-454-07 7 cm children
 26-454-09 9 cm adults



Weiss
 26-456-08
 8 cm



Lister - Burch
 26-460-08
 8 cm



Williams
 26-462-07 7 cm children
 26-462-08 8 cm adults



Park
 26-466-08
 8 cm



Park Guyton
 26-468-08
 8 cm

for left eye

for right eye



Park - Maumenee
 26-470-08
 8 cm



Arruga
 26-474-07
 7 cm

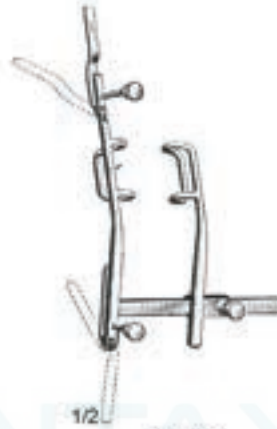

Arruga
 26-476-07
 7 cm



Murdock
 26-478-05
 5 cm



Cook
 26-480-04 4 cm children
 26-480-05 5 cm adults



Mellinger
 26-484-05 5 cm children
 26-484-07 7 cm adults



Mellinger - Axenfeld
 26-486-07
 7 cm



Mellinger - Axenfeld
 26-488-07
 7 cm



Mellinger Beard
 26-500-05 5 cm children
 26-500-07 7 cm adults



Sauer
 26-504-03
 3 cm



Castroviejo
 26-508-08
 8 cm



Stevenson
 26-510-07
 7 cm



Mueller
 26-514-07
 7 cm



Agricola
 26-518-04
 4 cm



Goldstein
26-520-03
3 cm



26-524-16
16 cm

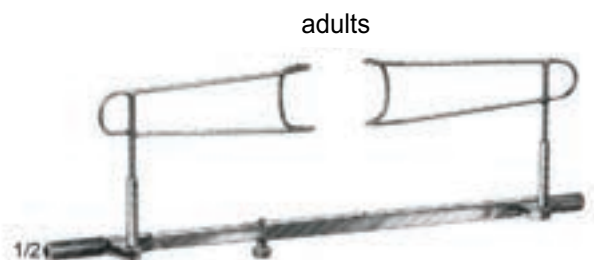

adults
Schott
26-528-14
14 cm



Sautter
26-550-01 - 26-550-03
14.5 cm





Hirschmann
26-572-14



Jaffe
26-574-14



Kwitko
26-576-14

width of spatula 0.5 mm 1.0 mm

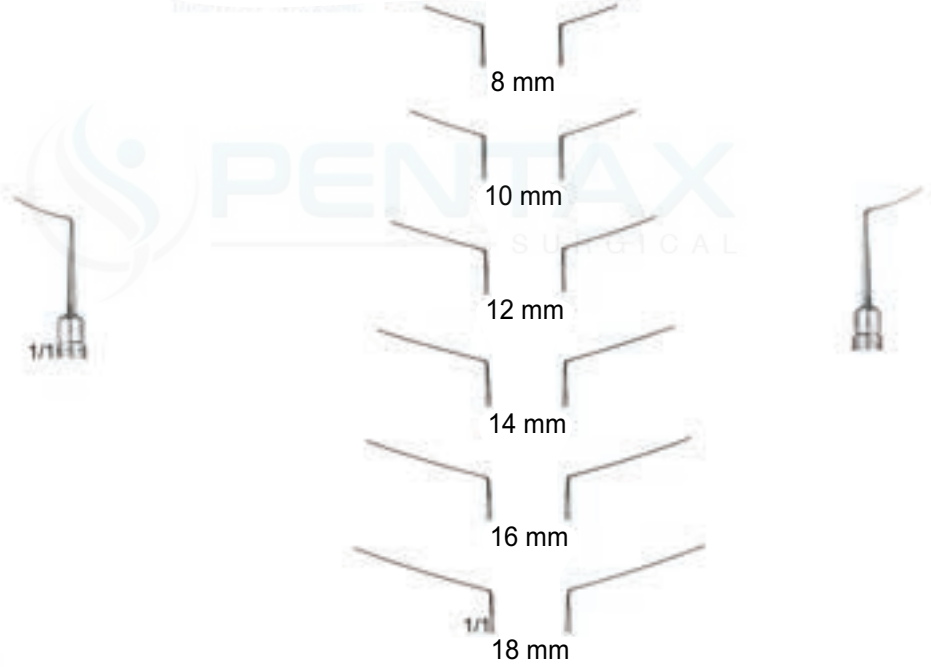

Castroviejo - Barraquer
26-580-08 - 26-582-18

26-580-08	8 mm	26-582-08
26-580-10	10 mm	26-582-10
26-580-12	12 mm	26-582-12
26-580-14	14 mm	26-582-14
26-580-16	18 mm	26-582-16
26-580-18	18 mm	26-582-18

1.2 x 12 mm



Elschnig
26-590-13

0.25 x 12 mm



Barraquer - Fino
26-592-12

1.2 x 10 mm



Castroviejo
26-596-13



1.5 x 15 mm



Castroviejo
26-598-14

0.8 x 15 mm



Castroviejo
26-600-09
9 cm



Castroviejo
26-606-09
9.5 cm



1/20

serrated



Troutman
26-611-13
13 cm



Lewis
26-613-14



Lewis
26-615-14



Weber
26-617-13



Weber
26-619-14



Snellen
26-623-13



Arlt
26-625-13 - 26-627-13



26-625-13
smooth



26-627-13
serrated



1/2



Sinskey
26-640-13
13 cm

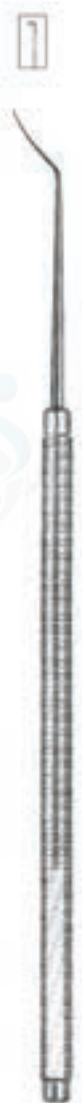

Sinskey - Cornic
26-641-13
13 cm



Sinskey
26-643-13
13 cm



Jaffe - Berchert
26-646-11
11 cm



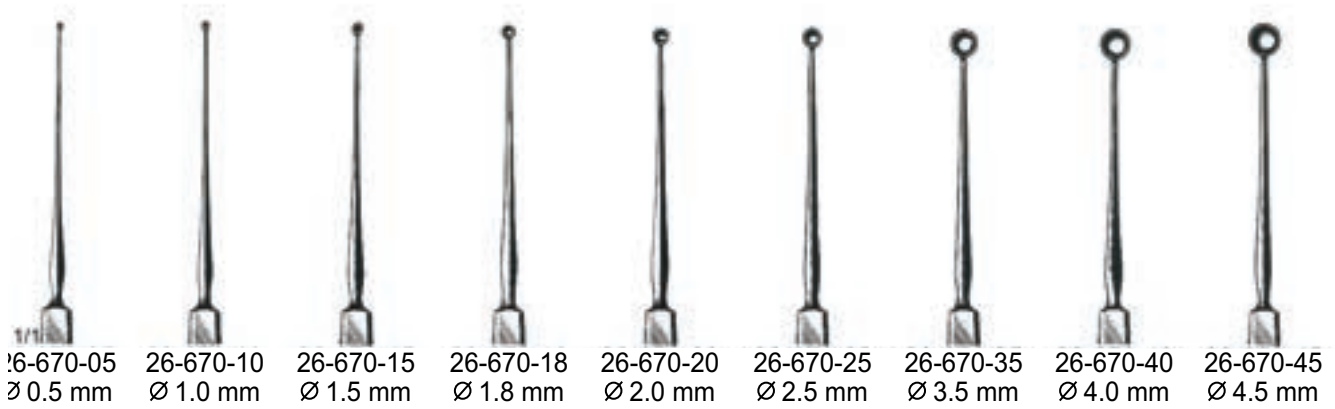

Meyhoefer
 26-670-05 - 26-670-45



Hebra
 26-676-10 - 26-676-35



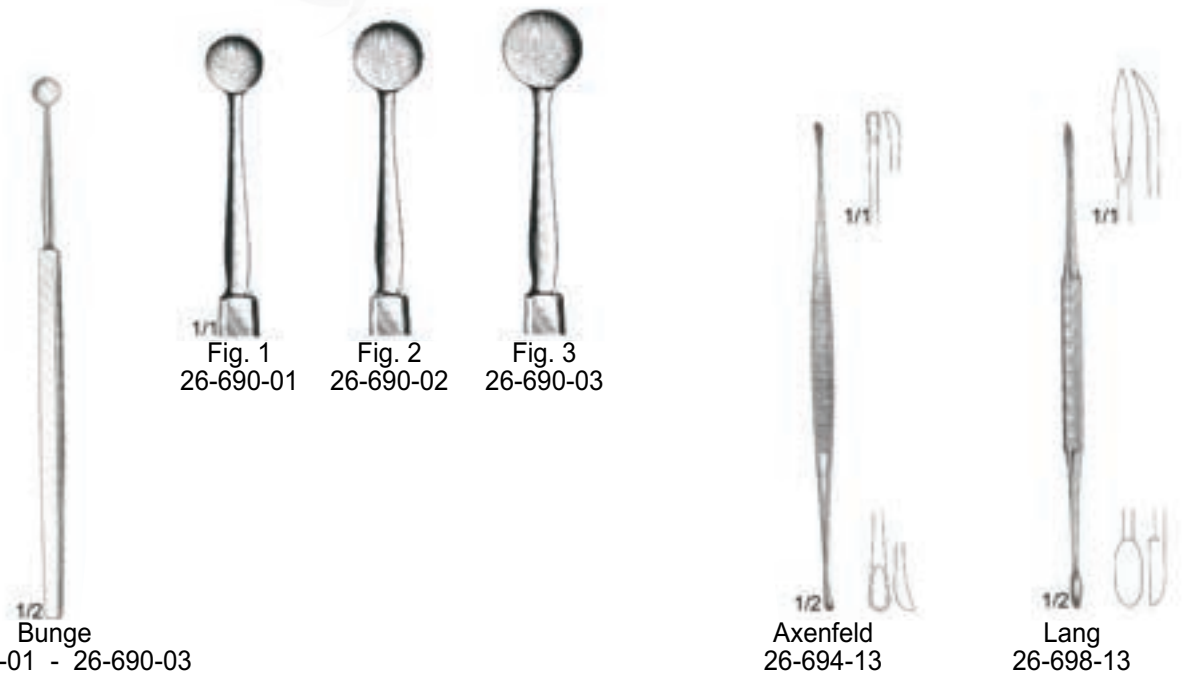
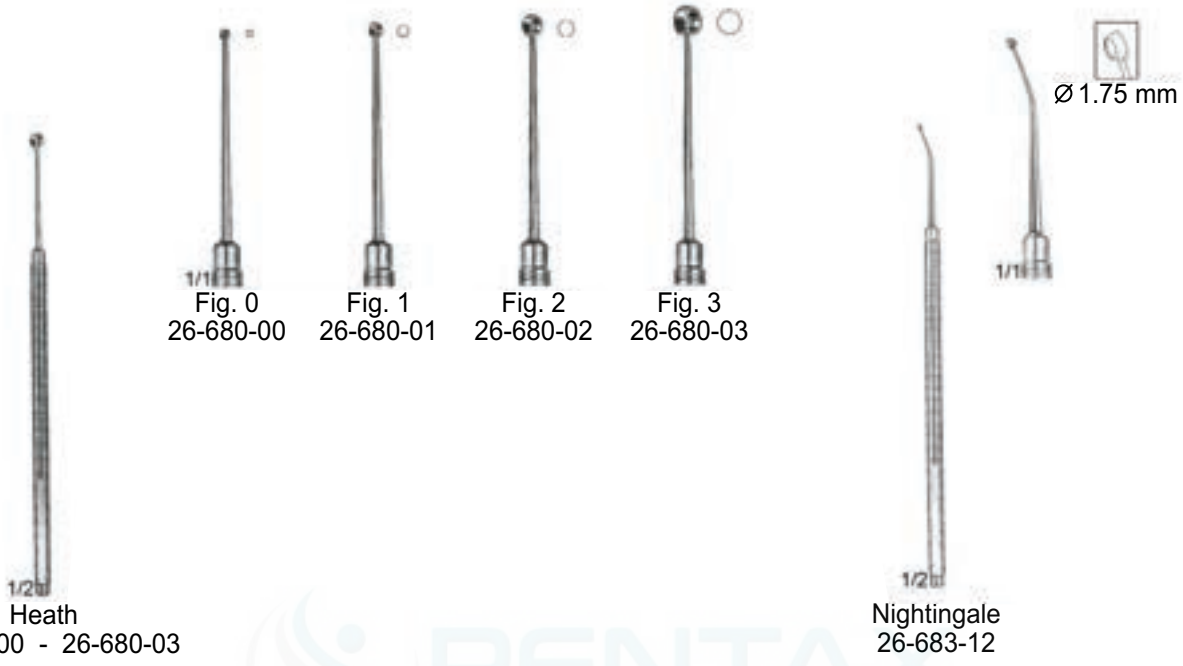



Paufique
26-721-11



Barraquer
26-723-13



Haitz
26-740-09



Holth
26-743-09



West
26-746-16



West
26-748-16





27



Troutman - Castroviejo
27-101-10
10 cm



Troutman - Castroviejo
27-105-01
10 cm



Troutman - Castroviejo
27-105-02
10 cm



Troutman - Castroviejo
 27-120-01
 10.5 cm



Troutman - Castroviejo
 27-120-02
 10.5 cm



Aebli
 27-127-10
 10 cm



Ong
 27-133-10
 10 cm

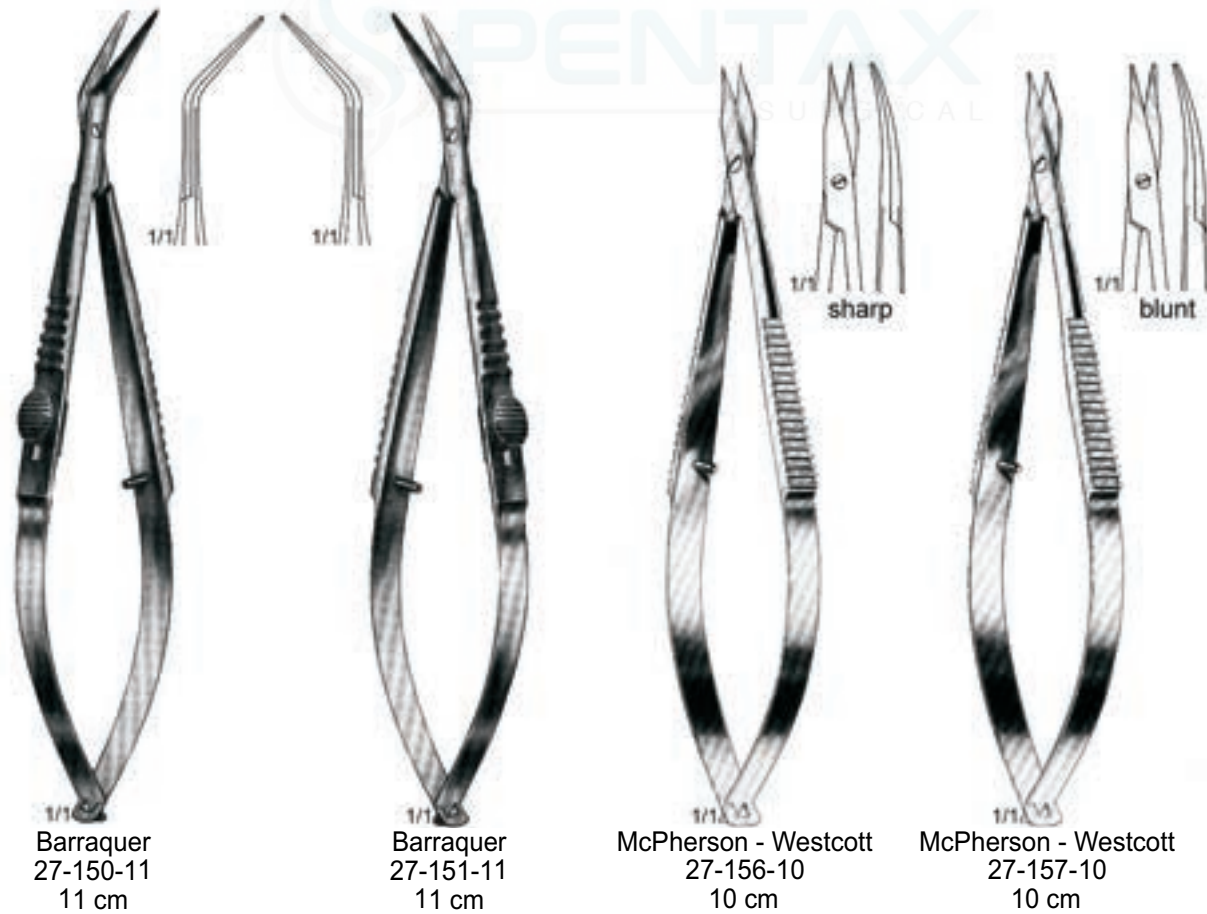



Gills - Welsch
27-170-01
8 cm

Gills - Welsch
27-170-02
8 cm

Gills - Welsch
27-170-03
8.5 cm



Castroviejo
27-191-01
10 cm



Castroviejo
27-191-01
10 cm



Troutman - Castroviejo
27-195-01
10 cm



Troutman - Castroviejo
27-195-02
10 cm

Measuring Range: 15 mm



Castroviejo
27-300-06

Measuring Range: 20 mm



Castroviejo
27-304-06



Measuring Range: 20 mm



Castroviejo - Schachar
27-305-06



Connin - Amsler
27-308-13



Ziegler
 27-321-01 Fig. 1/2
 27-321-02 Fig. 3/4
 27-321-03 Fig. 5/6



Castroviejo
 27-326-12



Fig. 1
 27-330-01



Fig. 2
 27-330-02



Fig. 3
 27-330-03



Wilder
 27-330-01 - 27-330-03



Harms
 27-334-01



Harms
 27-334-02

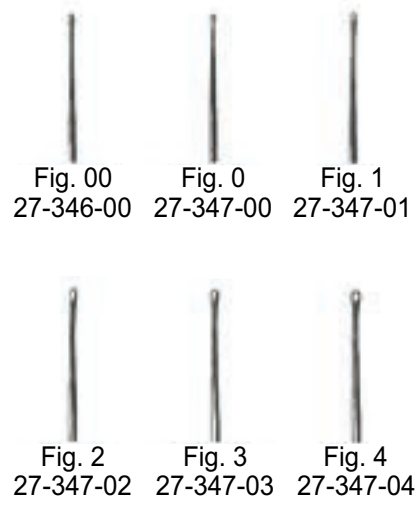
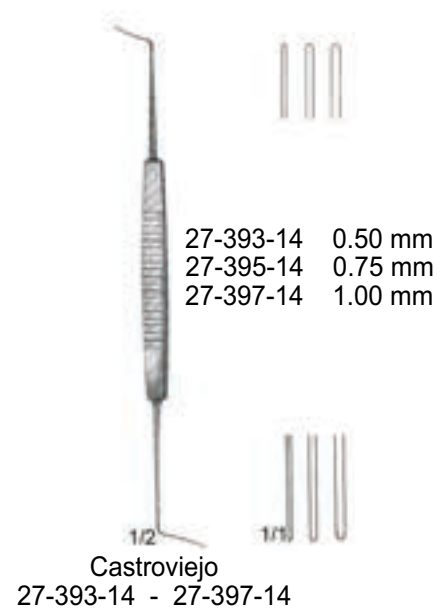

Fig.	00	0	1	2	3	4	5	6	7	8
Ø mm	0.7	0.8	0.9	1.1	1.3	1.4	1.5	1.6	1.8	1.9



Bowman		Bowman		Bowman	
27-360-00	Fig. 0/0	27-364-00	Fig. 00/0	27-366-00	Fig. 00/0
27-360-11	Fig. 0/1	27-364-01	Fig. 0/1	27-366-01	Fig. 0/1
27-360-22	Fig. 1/2	27-364-12	Fig. 1/2	27-366-12	Fig. 1/2
27-360-33	Fig. 2/3	27-364-23	Fig. 2/3	27-366-23	Fig. 2/3
27-360-44	Fig. 3/4	27-364-34	Fig. 3/4	27-366-34	Fig. 3/4
27-360-55	Fig. 4/5	27-364-45	Fig. 4/5	27-366-45	Fig. 4/5
27-360-66	Fig. 5/6	27-364-56	Fig. 5/6	27-366-56	Fig. 5/6
27-360-77	Fig. 6/7	27-364-67	Fig. 6/7	27-366-67	Fig. 6/7
27-360-88	Fig. 7/8	27-364-78	Fig. 7/8	27-366-78	Fig. 7/8





27-402-13



27-404-13



27-406-13



27-408-01
needle only



27-408-02
spud only



27-408-03
gouge only

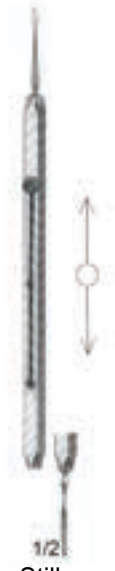

Stille
27-410-12



Stille
27-412-12



Dix
27-416-12



Dix
27-418-12



27-440-05
0.5 mm



27-440-07
0.7 mm



27-440-10
1.0 mm



27-441-05
0.5 mm



27-441-07
0.7 mm



27-441-10
1.0 mm

1/1
Graefe

27-440-05 - 27-440-10
7 cm

1/1
Graefe

27-441-05 - 27-441-10
7 cm



27-444-05
0.5 mm



27-444-07
0.7 mm



27-444-10
1.0 mm



27-445-05
0.5 mm



27-445-07
0.7 mm



27-445-10
1.0 mm

1/1
Graefe

27-444-05 - 27-444-10
7 cm
1:2 Teeth

1/1
Graefe

27-445-05 - 27-445-10
7 cm
1:2 Teeth



Stevens
27-450-10
10 cm



Stevens
27-451-10
10 cm



Stevens
27-453-10
10 cm



Stevens
27-456-10
10 cm
1:2 Teeth



Stevens
27-457-10
10 cm
1:2 Teeth



Stevens
27-459-10
10 cm
1:2 Teeth

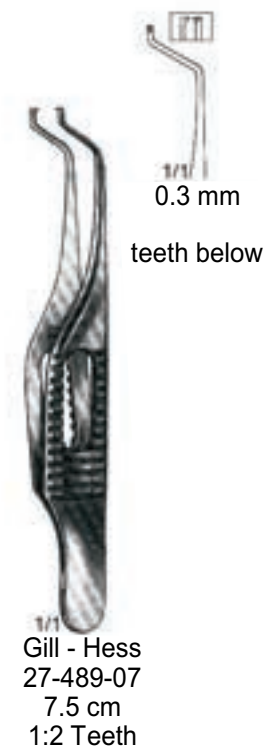

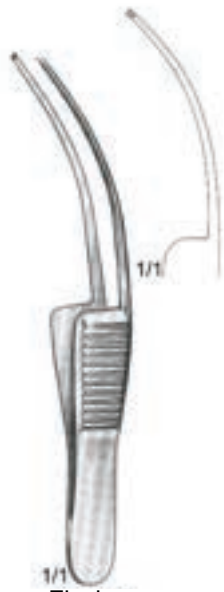

Fischer
 27-501-07
 7 cm
 1:2 Teeth



Fischer - Arnt
 27-503-07
 7 cm
 1:2 Teeth



Hess
 27-507-07
 7 cm
 1:2 Teeth



Hess
 27-509-07
 7 cm
 1:2 Teeth



Foerster
 27-510-08
 8.5 cm



Foerster
 27-511-08
 8.5 cm



Foerster
 27-516-08
 8.5 cm
 1:2 Teeth



Foerster
 27-517-08
 8.5 cm
 1:2 Teeth



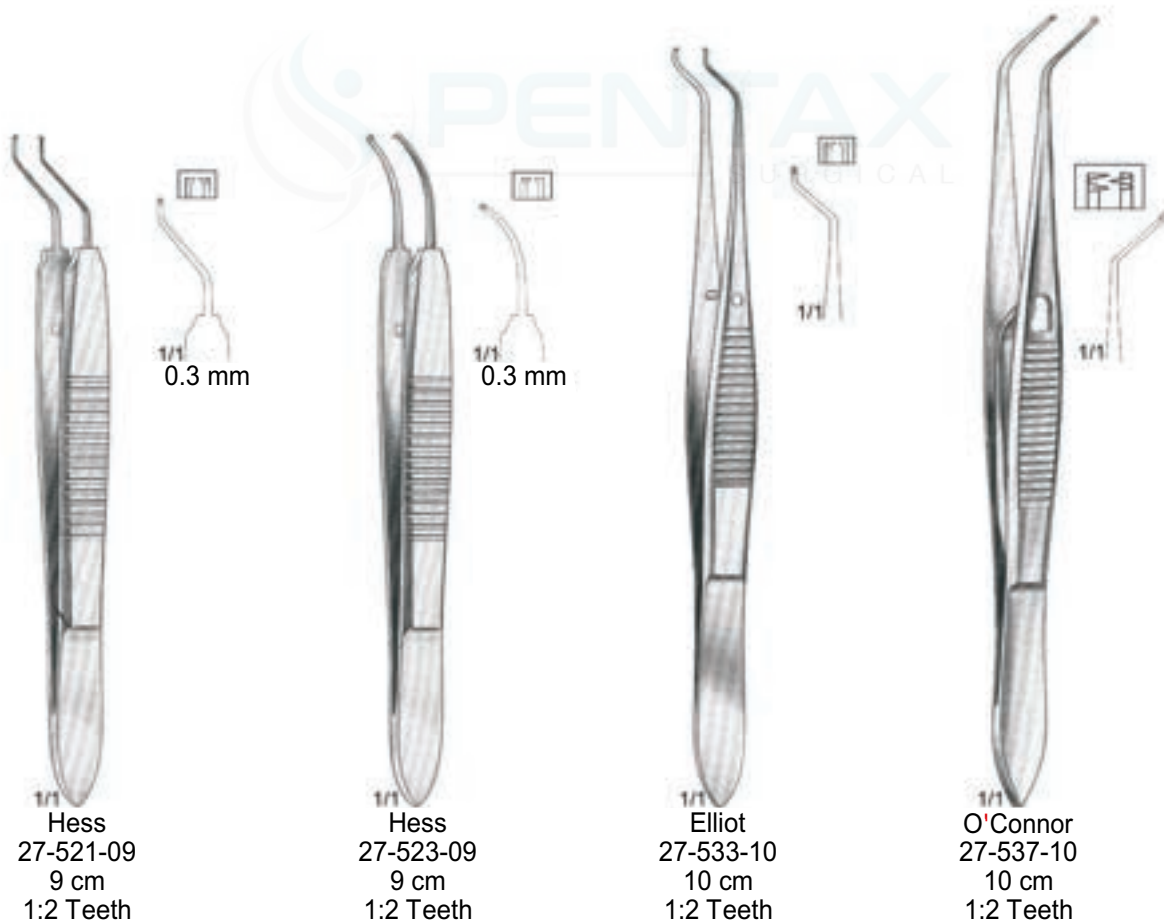

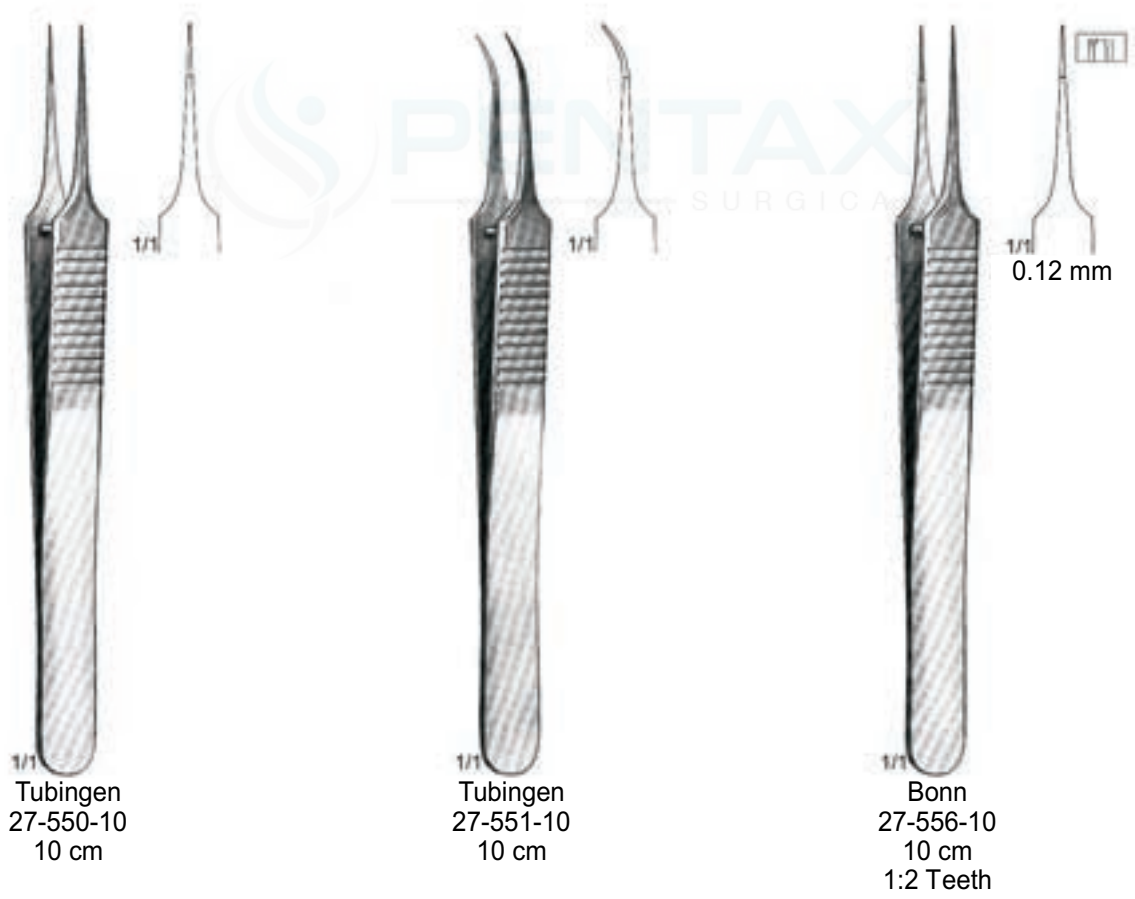



Castroviejo
27-560-01 - 27-560-15
10 cm
1:2 Teeth



Castroviejo
27-561-01 - 27-561-15
10 cm
1:2 Teeth

width of teeth

27-560-01	0.12 mm	27-561-01
27-560-03	0.30 mm	27-561-03
27-560-05	0.50 mm	27-561-05
27-560-10	1.00 mm	27-561-10
27-560-15	1.50 mm	27-561-15

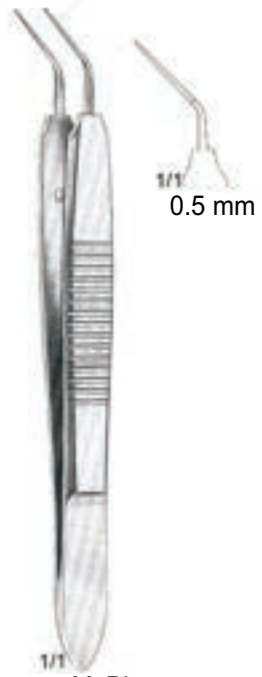
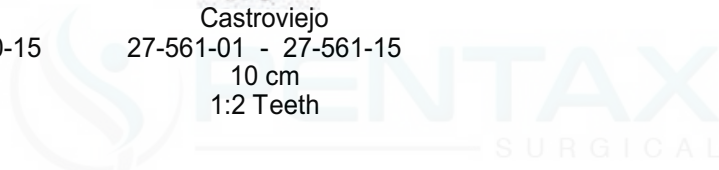

Kelman - McPherson
27-567-10
10 cm

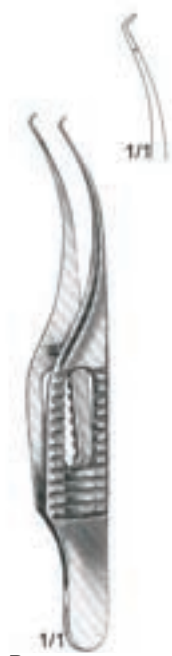

Barraquer
27-573-07
7 cm



St. Martin
27-580-07
7 cm
1:2 Teeth



Paufigue
27-584-01
8.5 cm



Paufigue
27-584-02
8.5 cm
1:2 Teeth



McPherson
27-591-01 - 27-591-02
10 cm



Moorfield
27-594-10
10 cm



Mod. Tubingen
27-596-10
10 cm



Barraquer
27-598-10
10 cm

without guide pin



Mod. Bonn
 27-610-07
 7 cm
 1:2 Teeth

with guide pin



Mod. Bonn
 27-612-07
 7 cm
 1:2 Teeth



Mod. Bonn
 27-614-07
 7 cm
 1:2 Teeth

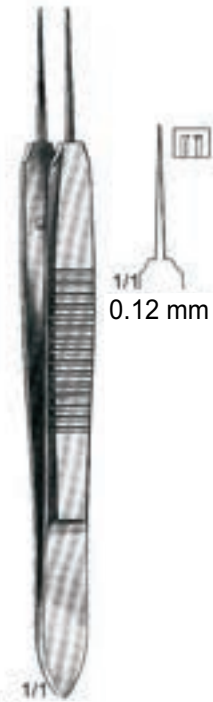

Mod. Bonn
 27-618-10
 10 cm
 1:2 Teeth



Bishop - Harman
 27-620-05
 8.5 cm



Bishop - Harman
 27-620-08
 8.5 cm



Bishop - Harman
 27-622-05
 8.5 cm
 1:2 Teeth

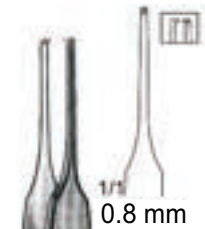

Bishop - Harman
 27-622-08
 8.5 cm
 1:2 Teeth

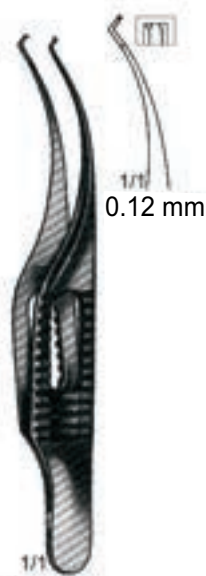

Barraquer (Colibri)
 27-630-07
 7 cm
 1:2 Teeth

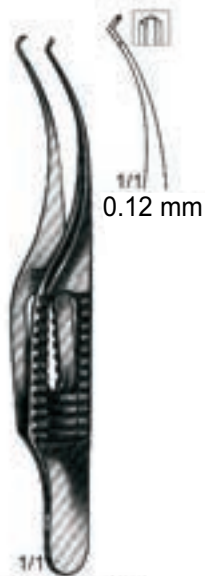

Barraquer (Colibri)
 27-631-07
 7 cm
 1:2 Teeth

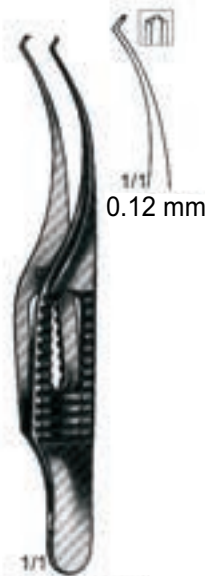

Barraquer - Katzin (Colibri)
 27-634-07
 7 cm
 1:2 Teeth

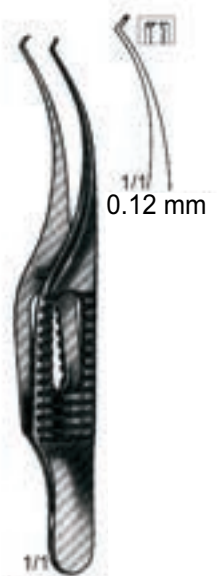

Barraquer - Katzin (Colibri)
 27-635-07
 7 cm
 1:2 Teeth

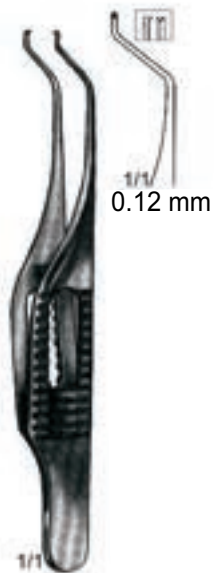

Troutman (Colibri)
 27-638-07
 7.5 cm
 1:2 Teeth



Kirby - Artur
 27-643-09
 9 cm
 1:2 Teeth



Kirby - Artur
 27-645-09
 9 cm
 1:2 Teeth



1/1
 Maumenee (Colibri)
 27-661-10
 10 cm
 1:2 Teeth



1/1
 Castroviejo (Colibri)
 27-665-10
 10 cm
 1:2 Teeth



1/1
 Willard (Colibri)
 27-669-13
 13 cm
 1:2 Teeth

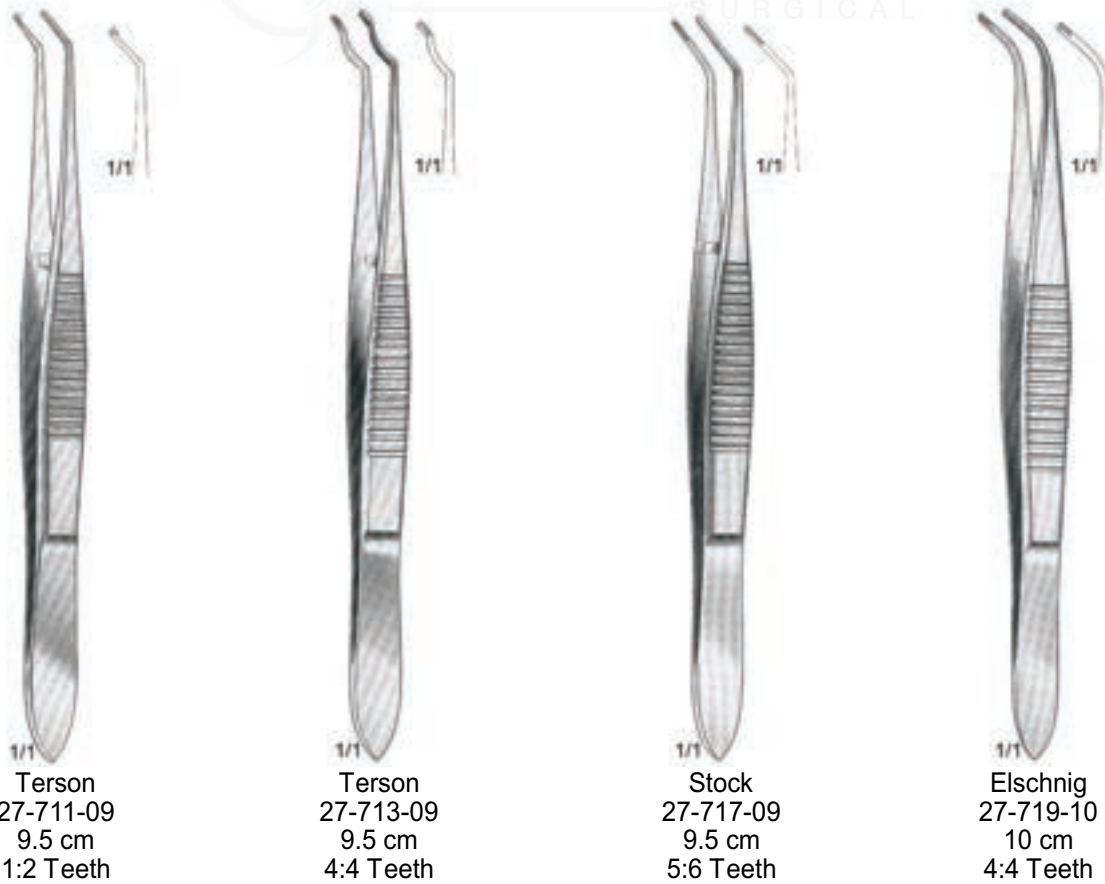
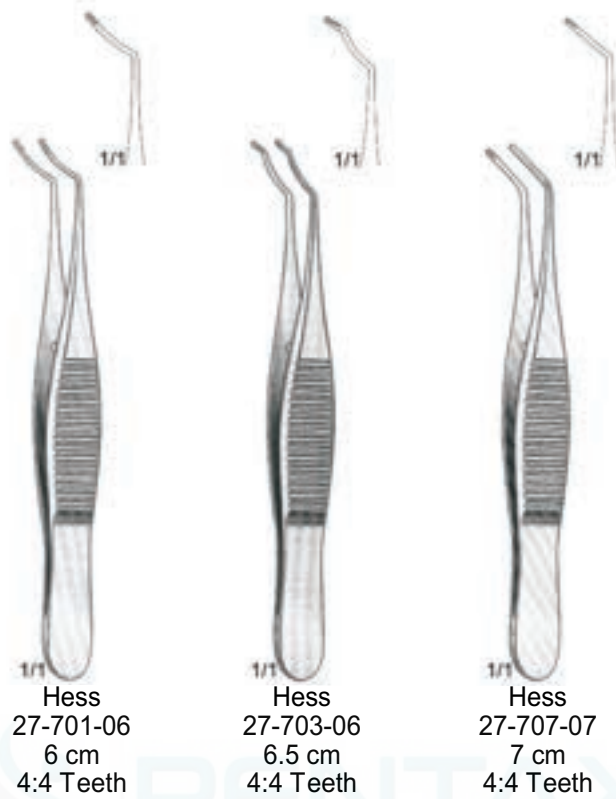

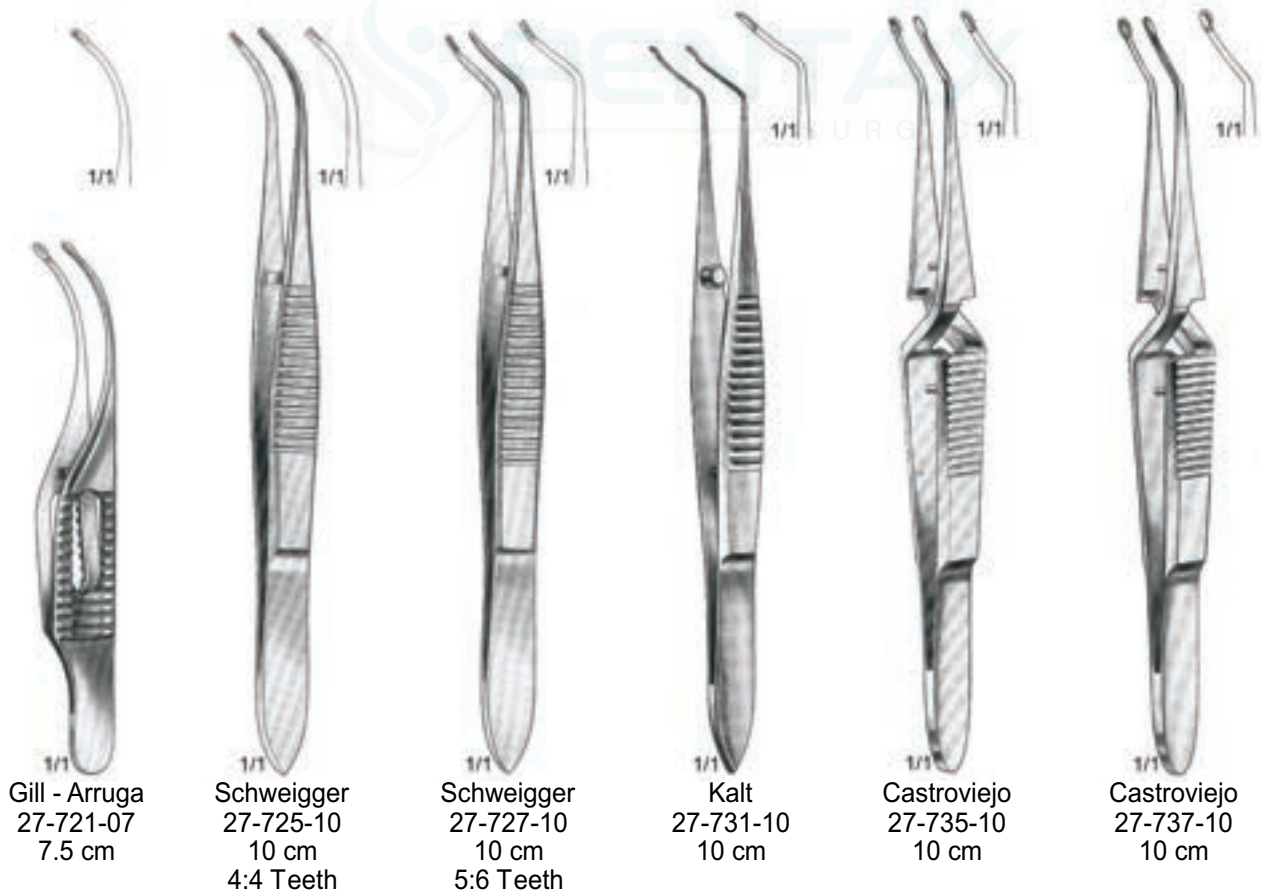

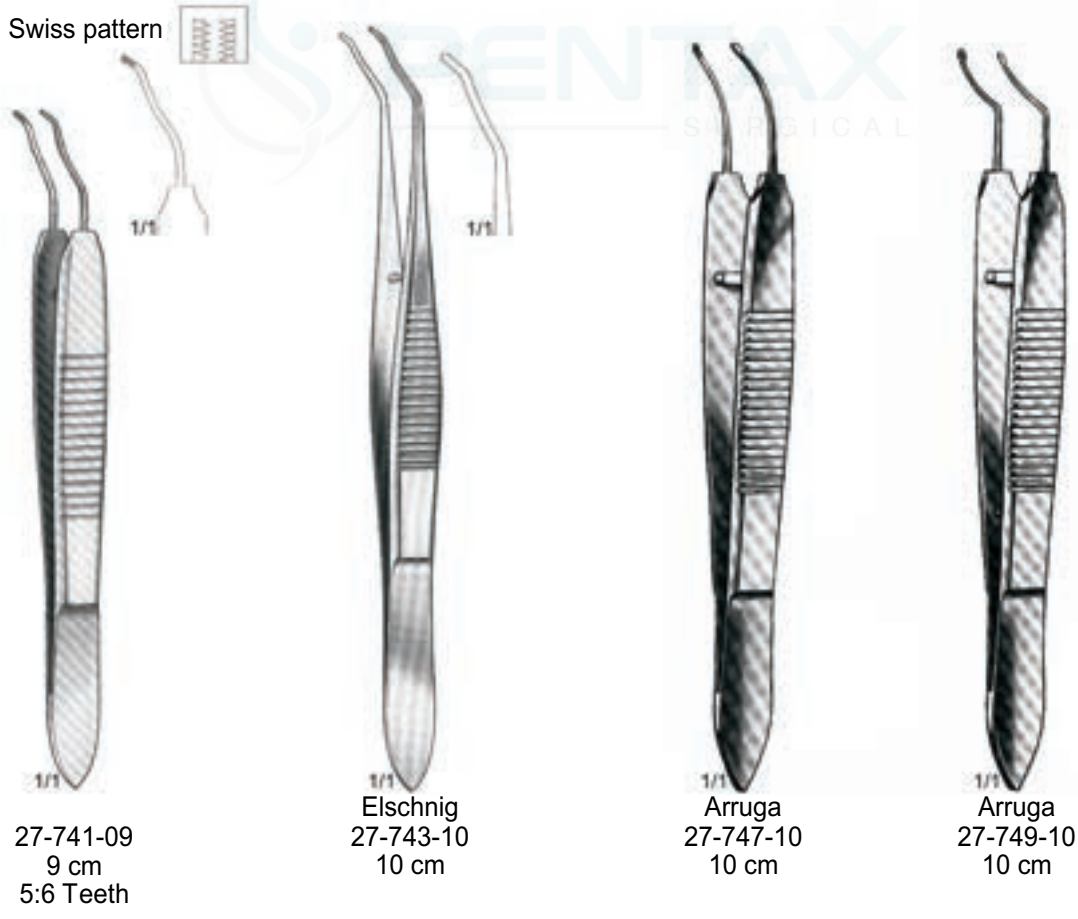



1/1
Binkhorst
 27-761-07
 7.5 cm



PENTAX
SURGICAL



1/1
Clayman
 27-763-08
 8 cm



1/1
Shepard
 27-765-08
 8 cm



1/1
Shepard
 27-767-08
 8 cm

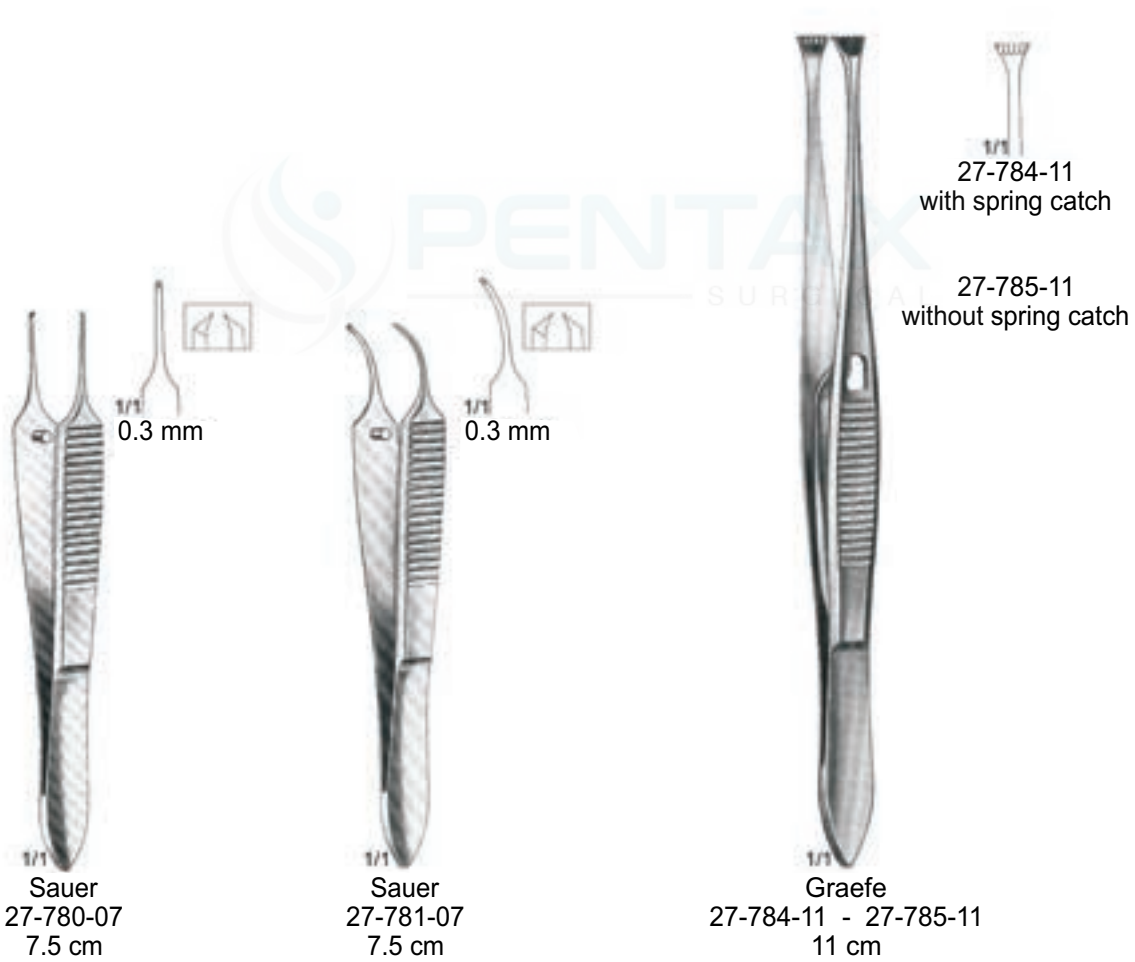



1/1
 Castroviejo
 27-800-09
 9 cm



1/1
 Castroviejo
 27-801-09
 9 cm



1/1
 Castroviejo
 27-804-09
 9 cm



1/1
 Castroviejo
 27-805-09
 9 cm



1/1
 Barraquer - Llovera
 27-808-09
 9 cm



1/1
 Barraquer
 27-810-10
 10 cm



1/1
 Green
 27-814-05 - 27-816-10
 10 cm



with spring catch		without spring catch
27-814-05	5 mm	27-816-05
27-814-10	10 mm	27-816-10

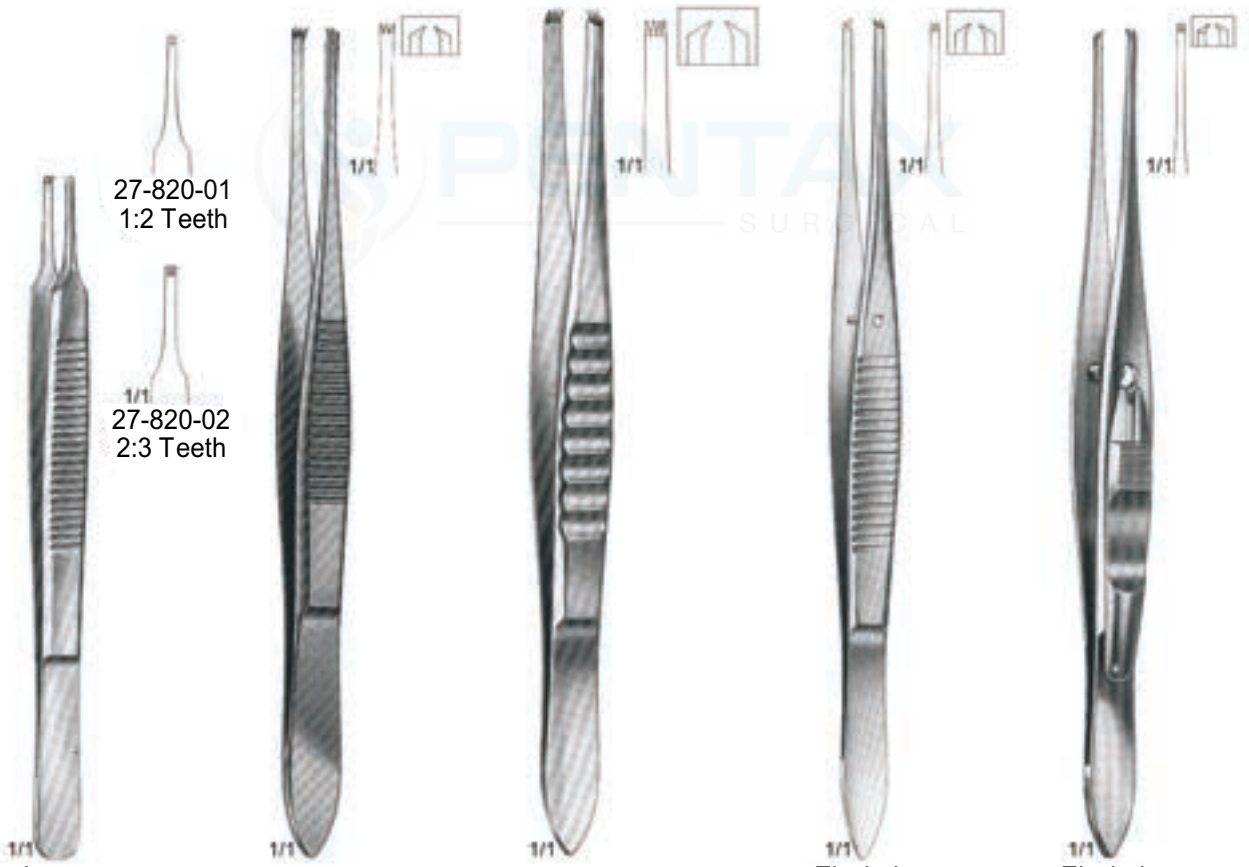

27-820-01
1:2 Teeth

1/1
27-820-02
2:3 Teeth

1/1
Lester
27-820-01 - 27-820-02
9 cm

1/1

1/1

1/1
27-824-11
11 cm
2:3 Teeth

1/1

1/1

1/1
27-828-11
11 cm
3:4 Teeth

1/1

1/1

1/1
Elschnig
27-832-11
11 cm
1:2 Teeth

1/1

1/1

1/1
Elschnig
27-836-11
11 cm
1:2 Teeth

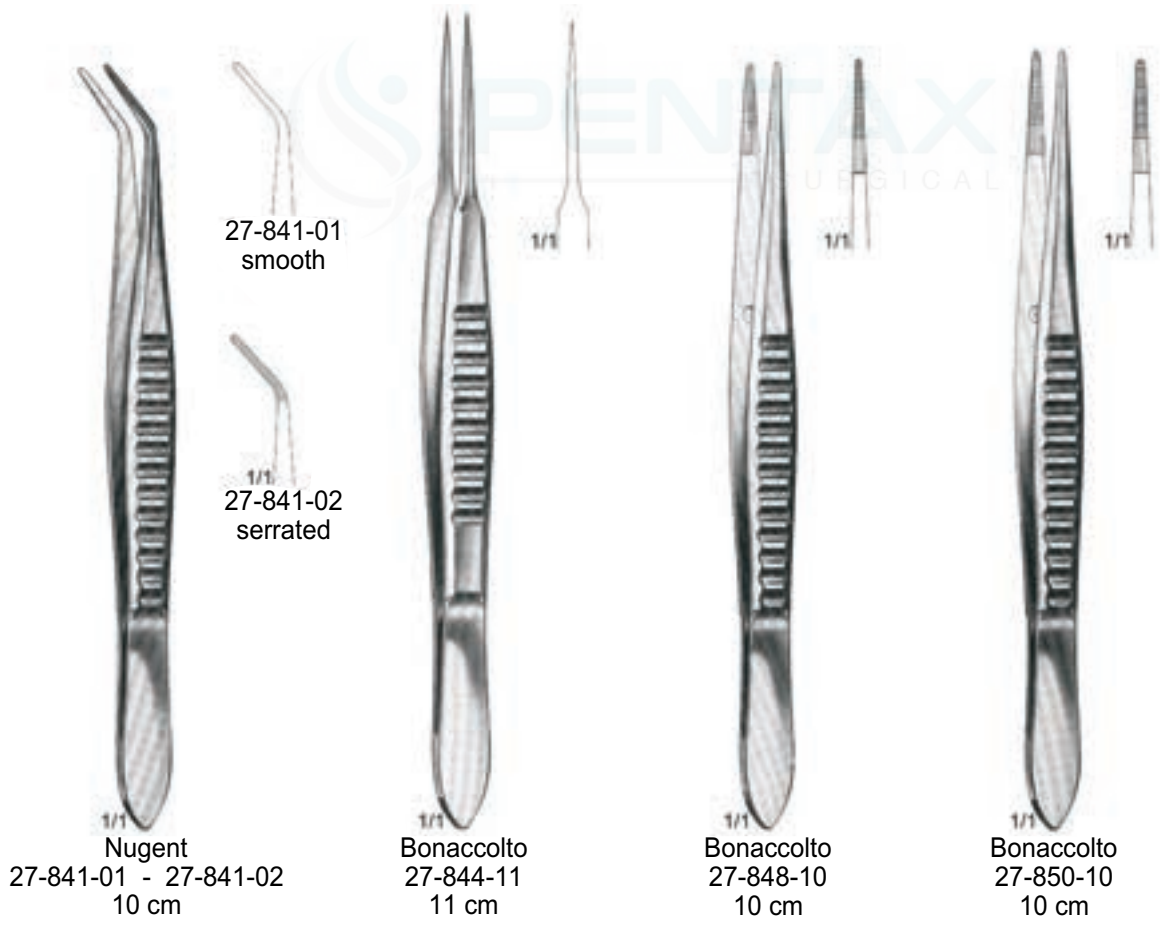



Dastoor
 27-855-10
 10 cm
 1:2 Teeth



Dastoor
 27-858-11
 11 cm



Dastoor
 27-860-11
 11 cm
 1:2 Teeth



Dastoor
 27-862-11
 11 cm
 2:3 Teeth

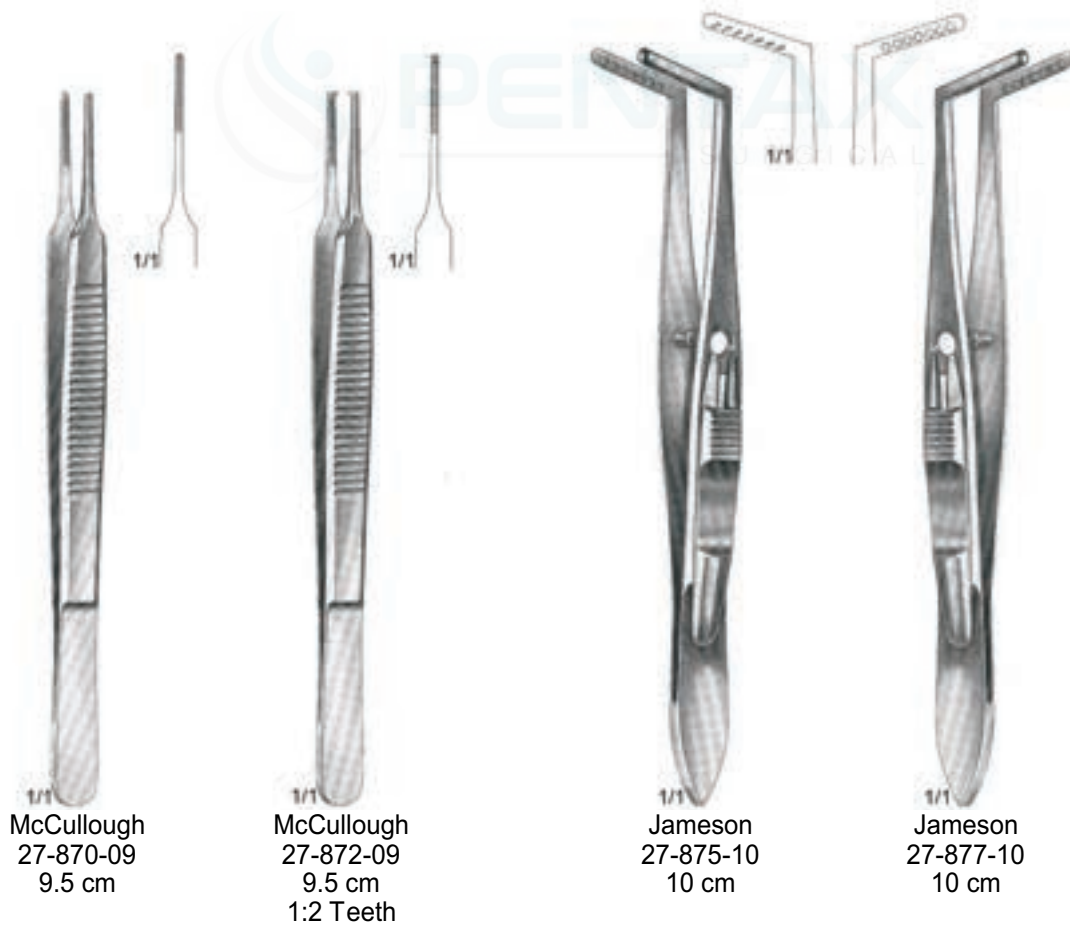

0.8 mm



Troutman - Rectus
27-890-08
8.5 cm
1:2 Teeth



Snellen
27-894-01
10 cm

Snellen
27-894-02
10 cm



Fink - Jameson
 27-911-10
 10 cm



Berens
 27-913-10
 10 cm



Bangerter
 27-915-10
 10 cm

Fig. 1
 27-925-01



Fig. 2
 27-925-02

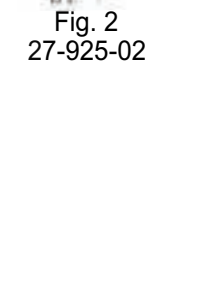

Berke
 27-925-01 - 27-925-02
 10 cm



Blascovics
 27-921-01
 9 cm



Blascovics
 27-921-02
 9 cm



Ayer
 27-940-01
 9 cm



Ayer
 27-940-02
 9 cm



Lambert
 27-944-09
 9 cm



Cauer
 27-948-10
 10 cm



Lordan
 27-954-09
 9 cm



Desmarres
 27-958-01 - 27-958-03
 9 cm



Fig. 1
 27-958-01



Fig. 2
 27-958-02



Fig. 3
 27-958-03

0.2 mm



1/1
 Dermot Pierse
 27-970-02
 8 cm

0.3 mm



1/1
 Dermot Pierse
 27-970-03
 8 cm

0.4 mm



1/1
 Dermot Pierse
 27-970-04
 8 cm

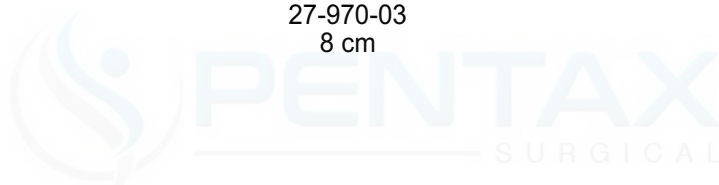

0.2 mm



1/1
 Dermot Pierse
 27-971-02
 8 cm

0.2 mm



1/1
 Dermot Pierse (Colibri)
 27-973-02
 8 cm

0.3 mm



1/1
 Dermot Pierse (Colibri)
 27-973-03
 8 cm

0.4 mm



1/1
 Dermot Pierse (Colibri)
 27-973-04
 8 cm

curved to left
for the right hand

curved to right
for the left hand

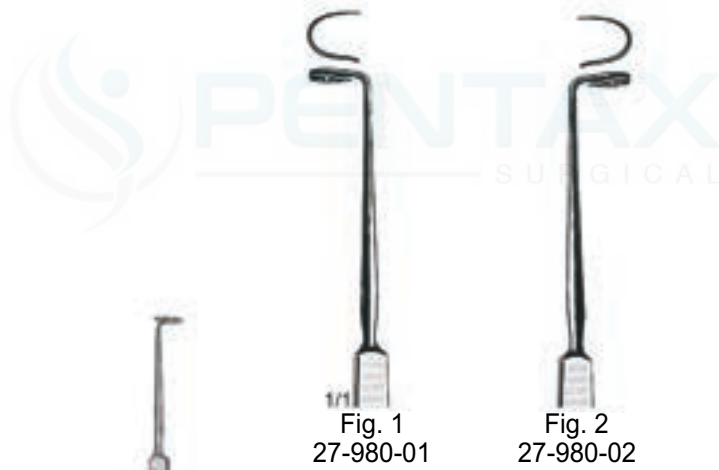



28



28-100-00



28-100-10



28-100-20



28-100-30



Anel
28-110-40



Anel
28-110-45



Bangerter
28-120-40 40 mm
28-120-60 60 mm



Mod. Bonn
28-140-00



Amsler
28-150-00



Schreck
28-160-00





Cranz
28-180-00



Castroviejo
28-190-00



Castroviejo
28-190-05

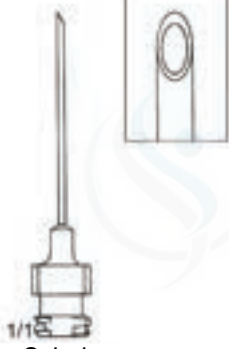

Scheie
28-210-10

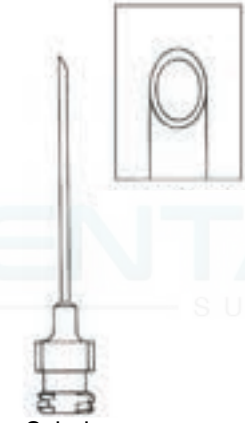

Scheie
28-210-15



Mod. Tubingen
28-230-00

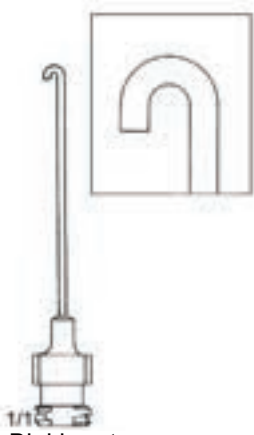

Binkhorst
28-240-10

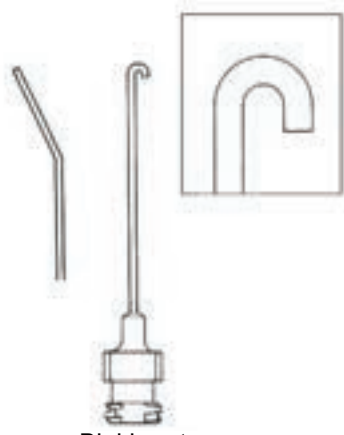

Binkhorst
28-240-20 Right
28-240-30 Left



1/16
 Simcoe
 28-260-00



Mod. Bonn
 28-280-00



Mod. Bonn
 28-280-10



Sauter
 28-290-00

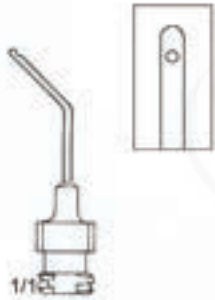

1/16
 28-300-00



28-310-00

Fig. 1
 1.1 mm



Ullerich
 28-330-10

Fig. 2
 1.5 mm

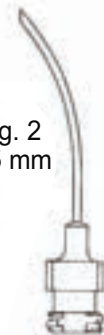

Ullerich
 28-330-20



1/16
 Sato
 28-350-00



Sheets
 28-360-00



Knolle - Pearce
 28-370-00



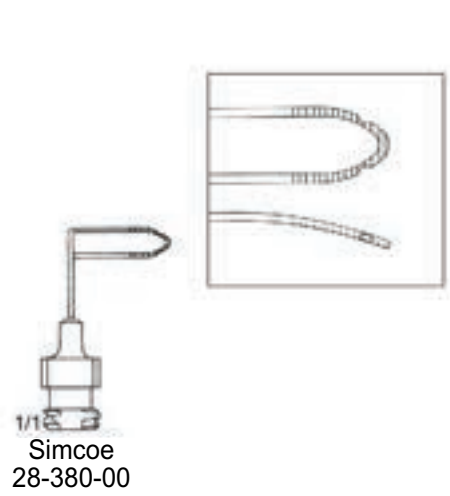

1/16
 Simcoe
 28-380-00

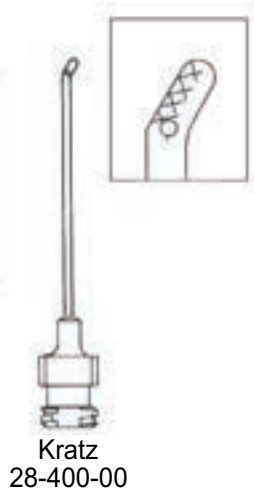

Kratz
 28-400-00

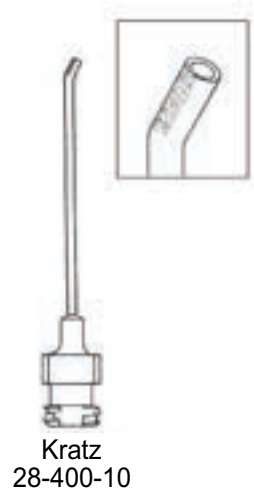

Kratz
 28-400-10

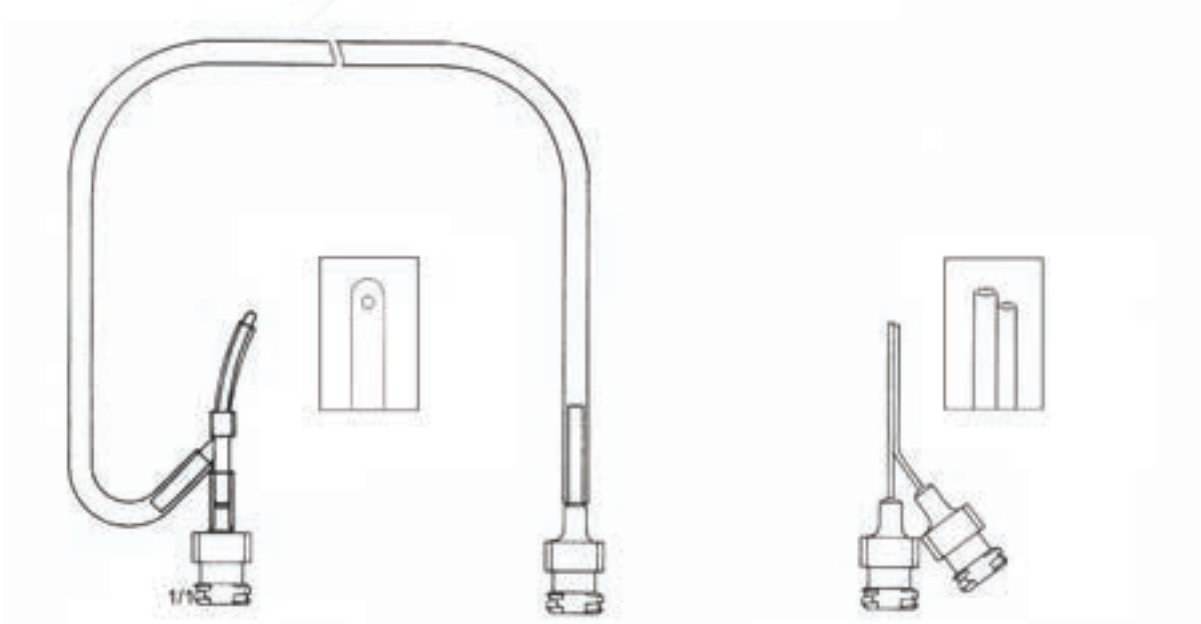

Friedburg
 28-430-10

Gills
 28-430-20

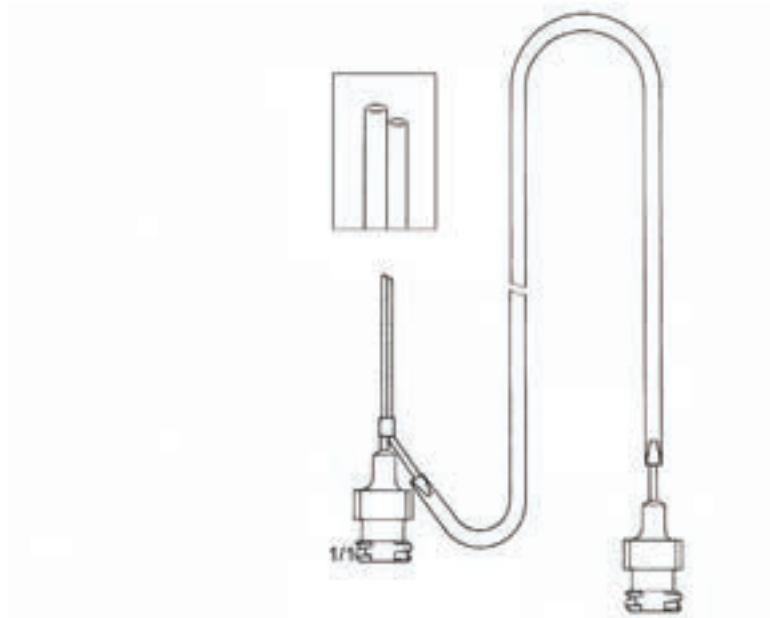

Gills - Welsh
28-430-30

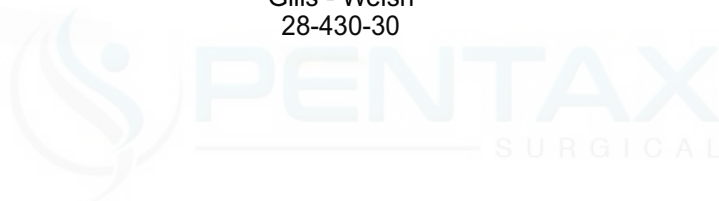

0.90 x 32 mm

O' Gawa
28-430-40

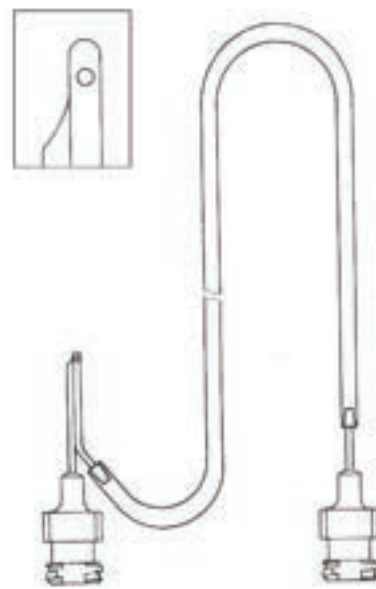

Simcoe
28-430-50

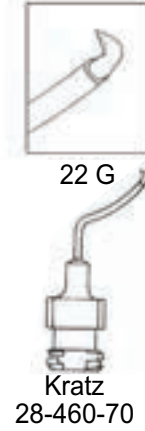
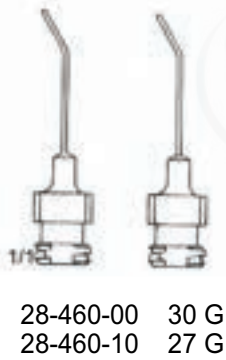
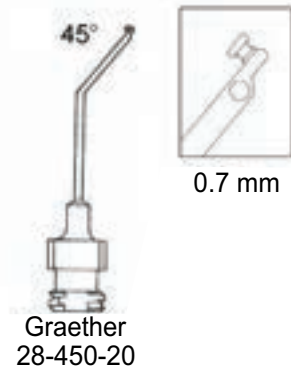
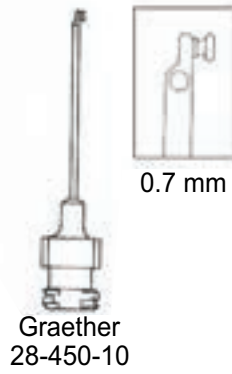
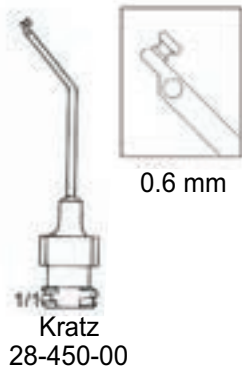

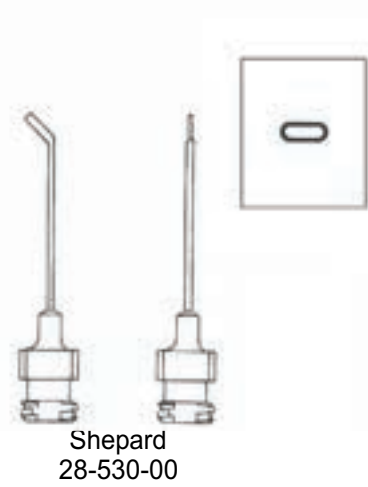
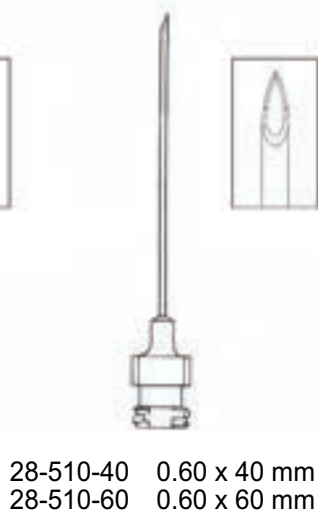
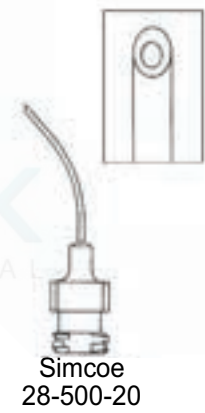
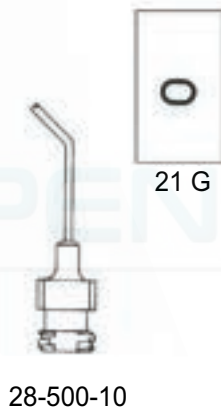
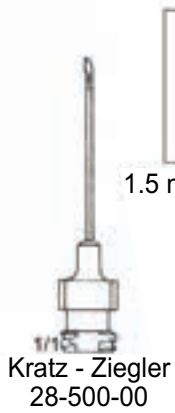
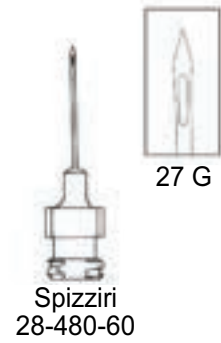
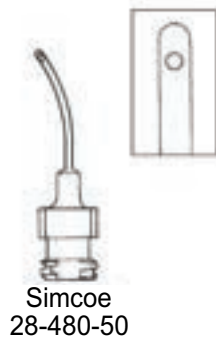
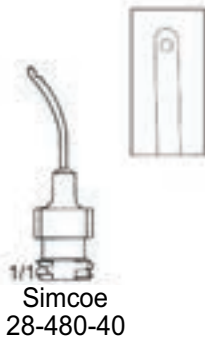

A

Advancement Forceps	27-34
Aebli Iris Scissors	27-3
Agricola Eye Specula	26-23
Alvis Foreign Body Instruments	26-11
Amsler Eye Cannulas	28-2
Anderson-Critchett Eye Knives	26-10
Anel Eye Cannulas	28-2
Arlt Lens Scoops	26-29
Arruga Capsular Forceps	27-25
Arruga Eye Specula	26-22
Arruga Hooks	26-18
Arruga Micro-Needle Holders	11-12, 11-13
Arruga Micro-Needle Holders with T/C Inserts	11-17
Arruga Retractors	26-18
Artery Forceps	07-3 – 07-4
Arthur Splinter Forceps	06-8
Axenfeld Dissectors	26-33
Axenfeld Hooks	26-17
Ayer Chalazion Forceps	27-35

B

Baby Mixer Artery Forceps	07-3
Backhaus Towel Forceps	07-5
Bangerter Advancement Forceps	27-34
Bangerter Cyclodialysis Spatulas	26-26
Bangerter Eye Cannulas	28-2, 28-8
Barkan Eye Knives	26-10
Barraquer (Colibri) Eye Specula	26-20
Barraquer (Colibri) Fixation Forceps	27-21
Barraquer Cilia Forceps	06-7
Barraquer Corneal Scissors	27-4
Barraquer Fixation Forceps	27-28
Barraquer Iris Scissors	05-12
Barraquer Keratoplastic Knives	26-34
Barraquer Micro-Needle Holders	11-2, 11-13
Barraquer Micro-Needle Holders with T/C Inserts	11-17
Barraquer Suture Forceps	27-18 – 27-19
Barraquer-Fino Cyclodialysis Spatulas	26-28
Barraquer-Katzin (Colibri) Fixation Forceps	27-21
Barraquer-Llovera Fixation Forceps	27-28
Barraquer-Troutman Micro-Needle Holders	11-2
Becker Cystotomes	26-14
Beer Cilia Forceps	06-7
Berens Advancement Forceps	27-34
Berens Eye Knives	26-6
Berke Entropium Forceps	27-34
Bernhard Towel Forceps	07-7
Binkhorst Eye Cannulas	28-3
Binkhorst Lens Implantation	27-26
Bishop-Harman Fixation Forceps	27-20
Blascovics Entropium Forceps	27-34
Bonaccolto Suture Forceps	27-30
Bonn Eye Scissors	05-6
Bonn Suture Forceps	27-17
Bowman Eye Knives	26-6 – 26-7
Bowman Eye Specula	26-20
Bowman Foreign Body Instruments	26-11
Bowman Lachrymal Dilators and Probes	27-9
Boynton Micro-Needle Holders with T/C Inserts	11-17
Brophy (Sullivan) Fine Operating Scissors	05-5
Bulldog Clamps	07-2
Bunge Scoops	26-33
Burch Eye Knives	26-10

C

Calipers	27-7
Capsular Forceps	27-23 – 27-25
Capsulotomy Scissors	27-5
Cartilage Scissors	05-17
Castroviejo (Colibri) Fixation Forceps	27-22
Castroviejo Calipers	27-7
Castroviejo Capsular Forceps	27-24
Castroviejo Corneal Scissors	05-14, 27-6
Castroviejo Cyclodialysis Spatulas	26-28
Castroviejo Eye Cannulas	28-3
Castroviejo Eye Knives	26-4, 26-6
Castroviejo Eye Specula	26-23
Castroviejo Fixation Forceps	27-28
Castroviejo Iris Scissors	05-12
Castroviejo Lid Instruments	26-19
Castroviejo Micro-Needle Holders	11-7 – 11-8, 11-14
Castroviejo Micro-Needle Holders with T/C Inserts	11-16, 11-18
Castroviejo Razor Blade Holders and Breakers	04-3
Castroviejo Spatula	26-28, 27-10
Castroviejo Suture Forceps	27-18
Castroviejo Trabecular Probes	27-8
Castroviejo-Barraquer Cyclodialysis Spatulas	26-27
Castroviejo-Barraquer Micro-Needle Holders	11-13
Castroviejo-Fine Micro-Needle Holders	11-9
Castroviejo-Kalt Micro-Needle Holders	11-12
Castroviejo-Schachar Calipers	27-7
Cataract Knives	26-2 – 26-3
Cauer Chalazion Forceps	27-35
Chadwick Eye Scissors	05-10
Chalazion Curettes	26-32 – 26-33
Chalazion Forceps	27-35
Chandler Iris Forceps	27-14
Chisels	26-34
Cilia Forceps	06-6 – 06-7
Clayman Lens Implantation	27-26
Conjunctival Forceps	27-15 – 27-16
Connin-Amsler Markers	27-7
Conway Lid Instruments	26-19
Cook Eye Specula	26-22
Corneal Knives	26-8 – 26-9
Corneal Scissors	27-4, 27-6, 05-14
Corneal Section Scissors	05-15 – 05-16
Craford Cartilage Scissors	05-17
Cranz Eye Cannulas	28-3
Critchett Eye Specula	26-20
Culler Cyclodialysis Spatulas	26-26
Cyclodialysis Spatulas	26-26 – 26-28
Cystotomes	26-14

D

Dastoor Strabismus Forceps	27-31
Daviel Spoons	26-31
Davis Foreign Body Instruments	26-11
Dean Corneal Knives	26-8
Dermot Pierser Fixation Forceps (Colibri)	27-36
Dermot Pierser Skeleton Forceps	27-36
Desmarres Chalazion Forceps	27-35
Deuschmann Eye Knives	26-4
Dieffenbach Bulldog Clamps	07-2
Dietrich Micro-Needle Holders with T/C Inserts	11-16
Dissectors	26-33

Dix Double – Ended Instruments	27-11	Green Foreign Body Instruments	26-12
Dix Foreign Body Instruments	26-11	Green Hooklets	26-18
Double – Ended Instruments	27-10 – 27-11	Green Spatula	27-10
Douglas Cilia Forceps	06-7	Guthrie Hooks	26-16
Doyen Towel Forceps	07-7	Guyton-Lundsgaard Eye Knives	26-10
E			
Elliot Conjunctival Forceps	27-16	H	
Ellis Foreign Body Instruments	26-12	Haitz Punches	26-34
Elschnig Capsular Forceps	27-23, 27-25	Halsted-Mosquito Artery Forceps	07-4
Elschnig Corneal Knives	26-9	Harms Lachrymal Probes	27-8
Elschnig Cyclodialysis Spatulas	26-28	Hartmann Artery Forceps	07-3
Elschnig Tissue Forceps	27-29	Heath Chalazion Curettes	26-33
English Model Towel Forceps	07-7	Hebra Chalazion Curettes	26-32
Enterotomy Scissors	05-17	Hepp-Scheidel Micro-Needle Holders with T/C Inserts	11-15
Entropium Forceps	27-34	Hess Capsular Forceps	27-23
Enucleation Eye Scissors	05-7	Hess Conjunctival Forceps	27-15 – 27-16
Eye Cannulas	28-2 – 28-8	Hess Lens Expressors	26-31
Eye Knives	26-4, 26-6 – 26-7, 26-10	Hirschmann Cyclodialysis Spatulas	26-27
	26-2	Hirschmann Hooks	26-16
Eye Scalpels	26-2	Hirschmann Iris Hooks	26-15
Eye Scissors	05-6 – 05-11	Holth Punches	26-34
Eye Specula	26-20 – 26-24	Hooklets	26-18
		Hooks	26-16 – 26-18
		Hunter Splinter Forceps	06-6
F			
Feilchenfeld Splinter Forceps	06-6	I	
Fine Operating Scissors	05-2 – 05-5	Iris Eye Scissors	05-6
Fine Pattern Forceps	06-2 – 06-3	Iris Forceps	27-12 – 27-14
Fink Hooks	26-16	Iris Hooks	26-15
Fink-Jameson Advancement Forceps	27-34	Iris Scissors	05-12, 27-3
Finochietto Cartilage Scissors	05-17		
Fischer Conjunctival Forceps	27-15	J	
Fischer-Arlt Conjunctival Forceps	27-15	Jaboma Micro-Needle Holders with T/C Inserts	11-15
Fixation Forceps	27-20 – 27-22, 27-27 – 27-28	Jacobson Micro-Needle Holders	11-8
	27-36	Jacobson Micro-Needle Holders with T/C Inserts	11-18
Fixation Forceps (Colibri)	27-36	Jaeger Hooks	26-18
Foerster Conjunctival Forceps	27-15	Jaeger Lid Instruments	26-19
Foreign Body Instruments	26-11 – 26-13	Jaeger-Grieshaber Keratomes	26-5
Francis Foreign Body Instruments	26-11	Jaffe Cyclodialysis Spatulas	26-27
Freemann Eye Cannulas	28-7	Jaffe-Berchert Lens Manipulators	26-30
Friedburg Eye Cannulas	28-5	Jameson Hooklets	26-18
Fuchs Iris Forceps	27-14	Jameson Muscular Forceps	27-32
		Jeffe-Knolle Iris Hooks	26-15
		Jensen Eye Cannulas	28-7
		Johns Hopkins Bulldog Clamps	07-2
		Jones Towel Forceps	07-5
		Jones-Martin Towel Forceps	07-5
		Joseph Fine Operating Scissors	05-2
G			
Gill Corneal Knives	26-9	K	
Gill Iris Forceps	27-14	Kalt Capsular Forceps	27-24
Gill-Arruga Capsular Forceps	27-24	Kalt Micro-Needle Holders	11-12
Gill-Hess Iris Forceps	27-14	Kalt Micro-Needle Holders with T/C Inserts	11-18
Gills Eye Cannulas	28-5	Kalt-Arruga Micro-Needle Holders	11-12
Gills-Welsch Capsulotomy Scissors	27-5	Katzin Corneal Section Scissors	05-15
Gills-Welsch Eye Cannulas	28-6	Katzin-Barraquer Corneal Section Scissors	05-15
Goldstein Eye Specula	26-24	Kelman Eye Cannulas	28-7
Gomel Micro Forceps	06-4	Kelman-McPherson Suture Forceps	27-18
Gomel Micro-Needle Holders	11-6	Keratomes	26-5
Gradle Splinter Forceps	06-8	Keratotomy Scissors	27-3
Graefe Cataract Knives	26-2 – 26-3	Keratoplastic Knives	26-34
Graefe Cystotomes	26-14	Kilner Fine Operating Scissors	05-3
Graefe Eye Knives	26-6	Kirby-Artur Fixation Forceps	27-21
Graefe Eye Scissors	05-10	Knapp Eye Knives	26-7
Graefe Eye Specula	26-20	Knapp Hooks	26-16
Graefe Fine Pattern Forceps	06-2	Knapp Spoons	26-31
Graefe Fixation Forceps	27-27		
Graefe Hooks	26-16, 26-18		
Graefe Iris Forceps	27-12		
Graefe Iris Hooks	26-15		
Graefe Spoons	26-31		
Graefe-Arruga Cataract Knives	26-3		
Graether Eye Cannulas	28-7		
Green Fixation Forceps	27-28		

Knapp-Clark Eye Specula	26-20	Muscular Forceps	27-32 – 27-33
Knapp-Rollet Hooks	26-17		
Knolle Iris Hooks	26-15	N	
Knolle-Pearce Eye Cannulas	28-4	Nevyas Eye Cannulas	28-7
Knotting Micro Forceps	06-5	Nicati Foreign Body Instruments	26-12
Kratz Eye Cannulas	28-5, 28-7	Nightingale Chalazion Curettes	26-33
Kratz-Ziegler Eye Cannulas	28-8	Noyes Corneal Section Scissors	05-16
Kuhnt Corneal Knives	26-8	Noyes Iris Scissors	05-12
Kwitko Cyclodialysis Spatulas	26-27	Nugent Suture Forceps	27-30
L		O	
La Force Foreign Body Instruments	26-11	O'Brien Eye Scissors	05-8
La Grange Eye Scissors	05-10	O'Connor Conjunctival Forceps	27-16
Labectomy Scissors	05-17	O'Connor Iris Hooks	26-15
Lachrymal Dilators and Probes	27-9	O'Gawa Eye Cannulas	28-6
Lachrymal Probes	27-8	Ong Iris Scissors	27-3
Lambert Chalazion Forceps	27-35	Orbit Spatulas	26-25
Lancaster Eye Specula	26-21		
Landolt Eye Scissors	05-8		
Lane Towel Forceps	07-6	P	
Lang Dissectors	26-33	Papst Eye Knives	26-6
Lang Expressors	26-31	Park Eye Specula	26-21
Lens Implantation	27-26	Park Guyton Eye Specula	26-21
Lens Manipulators	26-30	Park-Maumenee Eye Specula	26-22
Lens Scoops	26-29	Paton Corneal Knives	26-9
Lester Tissue Forceps	27-29	Paton Micro-Needle Holders	11-12
Levinson Foreign Body Instruments	26-11	Paufique Keratoplastic Knives	26-34
Lewis Lens Scoops	26-29	Paufique Suture Forceps	27-19
Lid Instruments	26-19	Peck-Joseph Fine Operating Scissors	05-3
Ligature Needles	27-37	Peers-Bertram Towel Forceps	07-6
Lindner Spatula	27-10	Peet Splinter Forceps	06-8
Lister-Burch Eye Specula	26-21	Piange Foreign Body Instruments	26-12
Littauer Cilia Forceps	06-7	Pley Eye Specula	26-20
Littler Fine Operating Scissors	05-4	Potts-Smith Cartilage Scissors	05-17
Lordan Chalazion Forceps	27-35	Potts-Smith Micro-Needle Holders	11-12
Lorna Towel Forceps	07-6	Potts-Smith Micro-Needle Holders with T/C inserts	11-18
Lundsgaard Eye Knives	26-10	Punches	26-34
M		R	
Markers	27-7	Ralk Splinter Forceps	06-8
Martin Cartilage Scissors	05-17	Razor Blade Holders and Breakers	04-3
Maumenee (Colibri) Fixation Forceps	27-22	Reill Micro-Needle Holders	11-3
Mc Indoe Cartilage Scissors	05-17	Retractors	26-18
McCullough Strabismus Forceps	27-32	Reynolds Fine Operating Scissors	05-3
McGannan Hooks	26-16	Roeder Towel Forceps	07-5
McPherson Suture Forceps	27-19	Rollet Foreign Body Instruments	26-12
McPherson-Westcott Tenotomy Scissors	27-4		
Mellinger Beard Eye Specula	26-23		
Mellinger Eye Specula	26-22	S	
Mellinger-Axenfeld Eye Specula	26-22	Sanvenero Fine Operating Scissors	05-2
Meyer Foreign Body Instruments	26-12	Sato Corneal Knives	26-8
Meyer-Schwickerath Iris Hooks	26-15	Sato Eye Cannulas	28-4
Meyhoefer Chalazion Curettes	26-32	Sauer Eye Specula	26-23
Micro Forceps	06-4 – 06-5	Sauer Fixation Forceps	27-27
Micro Scissors	27-2	Sauter Eye Cannulas	28-4
Micro-Mosquito Artery Forceps	07-4	Sautter Orbit Spatulas	26-25
Micro-Needle Holders	11-2 – 11-14	Scalpel Handle No. 7	04-2
Micro-Needle Holders with T/C Inserts	11-15 – 11-18	Scalpel Handles	04-2
Mod. Barraquer Eye Specula	26-20	Schaedel Towel Forceps	07-5
Mod. Bonn Eye Cannulas	28-2, 28-4	Scheie Eye Cannulas	28-3
Mod. Bonn Fixation Forceps	27-20	Scheie Eye Knives	26-10
Mod. Bonn Iris Hooks	26-15	Schott Eye Specula	26-24
Mod. Hamburg Eye Knives	26-6	Schreck Eye Cannulas	28-2
Mod. Tubingen Eye Cannulas	28-3	Schweigger Capsular Forceps	27-24
Mod. Tubingen Iris Hooks	26-15	Schweiz Mod. Foreign Body Instruments	26-11
Mod. Tubingen Suture Forceps	27-19	Scoops	26-33
Moorfield Suture Forceps	27-19	Secondary Cataract Scissors	05-13
Mueller Eye Specula	26-23	Shaaf Cilia Forceps	06-7
Murdock Eye Specula	26-22	Sheets Eye Cannulas	28-4
		Shepard Eye Cannulas	28-8

Shepard Lens Implantation	27-26	Wells Spoons	26-31
Sichel Corneal Knives	26-8	Wessely-Grieshaber Keratomes	26-5
Simcoe Eye Cannulas	28-4 – 28-8	West Chisels	26-34
Sinsky Lens Manipulators	26-30	Westcott Corneal Section Scissors	05-16
Sinsky-Cornic Lens Manipulators	26-30	Westcott Tenotomy Scissors	05-14
Skeleton Forceps	27-36	Wheeler Dissector	27-10
Smith-Fisher Spatula	27-10	Wheeler Eye Knives	26-4
Snellen Lens Scoops	26-29	Wiener Eye Knives	26-6
Snellen Muscular Forceps	27-33	Wiener Iris Hooks	26-15
Spatula	26-28	Wilder Lachrymal Probes	27-8
Spizziri Eye Cannulas	28-8	Willard (Colibri) Fixation Forceps	27-22
Splinter Forceps	06-6, 06-8	Williams Eye Specula	26-21
Spoons	26-31	Wilmer Eye Scissors	05-10
St. Martin Suture Forceps	27-19	Woodruff Ligature Needles	27-37
Standard Foreign Body Instruments	26-13		
Standard Scalpel Handles No. 3	04-2	Z	
Standard Scalpel Handles No. 4	04-2	Ziegler Eye Knives	26-7
Stevens Eye Scissors	05-7	Ziegler Eye Specula	26-20
Stevens Hooklets	26-18	Ziegler Lachrymal Dilators and Probes	27-9
Stevens Iris Forceps	27-13	Ziegler Splinter Forceps	06-8
Stevens Micro-Needle Holders	11-12	Ziegler Trabecular Probes	27-8
Stevenson Eye Specula	26-23		
Stieglitz Splinter Forceps	06-8		
Stille Double – Ended Instruments	27-11		
Stock Capsular Forceps	27-23		
Stock Cyclodialysis Spatulas	26-26		
Strabismus Eye Scissors	05-7		
Strabismus Forceps	27-31 – 27-32		
Suker Cyclodialysis Spatulas	26-26		
Suture Forceps	27-17 – 27-19, 27-30		

T

Tenotomy Scissors	05-14, 27-4
Terson Capsular Forceps	27-23
Tissue Forceps	27-29
Tohoku Towel Forceps	07-6
Took Corneal Knives	26-9
Towel Forceps	07-5 – 07-7
Trabecular Probes	27-8
Troutman (Colibri) Fixation Forceps	27-21
Troutman Corneal Knives	26-9
Troutman Corneal Scissors	05-14
Troutman Lens Scoops	26-29
Troutman Micro-Needle Holders	11-3
Troutman-Castroviejo Corneal Scissors	27-6
Troutman-Castroviejo Keratomy Scissors	27-3
Troutman-Castroviejo Micro Scissors	27-2
Troutman-Chris Razor Blade Holders and Breakers	04-3
Troutman-Rectus Muscular Forceps	27-33
Tubingen Suture Forceps	27-17

U

Ullerich Eye Cannulas	28-4
-----------------------	------

V

Vannas Mod. Tubingen Secondary Cataract Scissors	05-13
Vannas Secondary Cataract Scissors	05-13

W

Walter-Carmalt Splinter Forceps	06-6
Walton Eye Scissors	05-8
Walton Foreign Body Instruments	26-12
Weber Lens Scoops	26-29
Wecker Cyclodialysis Spatulas	26-26
Wecker Iris Scissors	05-12
Weiss Eye Specula	26-21