

Contents

Scalpel Handles	40-2
Razor Blade Holders and Breakers	40-3
Operating Scissors	40-4
Dissecting Scissors	40-10
Scissors for Cardiovascular Surgery	40-14
Eye Scissors	40-15
Iris Scissors	40-15
Secondary Cataract Scissors	40-17
Tenotomy Scissors	40-18
Micro Scissors	40-18
Dressing Forceps	40-19
Tissue Forceps	40-20
Grasping Forceps	40-21
Jeweler's Forceps	40-22
Tumor Forceps	40-23
Micro Forceps	40-24
Atrauma Tissue Forceps	40-25
Artery Forceps	40-27
Micro - Needle Holders	41-2
Needle Holders	41-4
Rib Spreaders	41-5
Atrauma Cardiovascular Forceps	41-10
Tissue and Organ Holding Forceps	41-12
Micro Spring Type Scissors	41-13
Micro Suture Tying Forceps	41-15
Micro Forceps, bayonet - shaped	41-17
Tumor and Tissue Grasping Forceps, bayonet- shaped	41-18
Micro Needle Holders, bayonet shaped	41-19
Exploration and Coagulation Hook	41-20
Tumor Knives	41-21
Micro Dissectors	41-23
Foreign Body Instruments	42-2
Cystotomes	42-4
Iris Hooks	42-5
Cyclodialysis Spatulas	42-6
Chalazion Curettes	42-7
Lachrymal Probes	42-8
Iris Forceps	42-9
Suture Forceps	42-11
Fixation Forceps	42-13
Skeleton Forceps	42-17
Fixation Forceps (Colibri)	42-17

for Fig. 10-17



1/1

Standard
 40-100-03
 12.0 cm
 No. 3

for Fig. 18-36

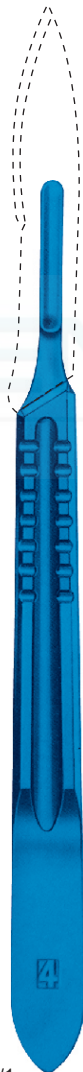

1/1

Standard
 40-110-04
 12.0cm
 No. 4

for Fig. 10-17



1/1

40-120-07
 16.0 cm
 No. 7

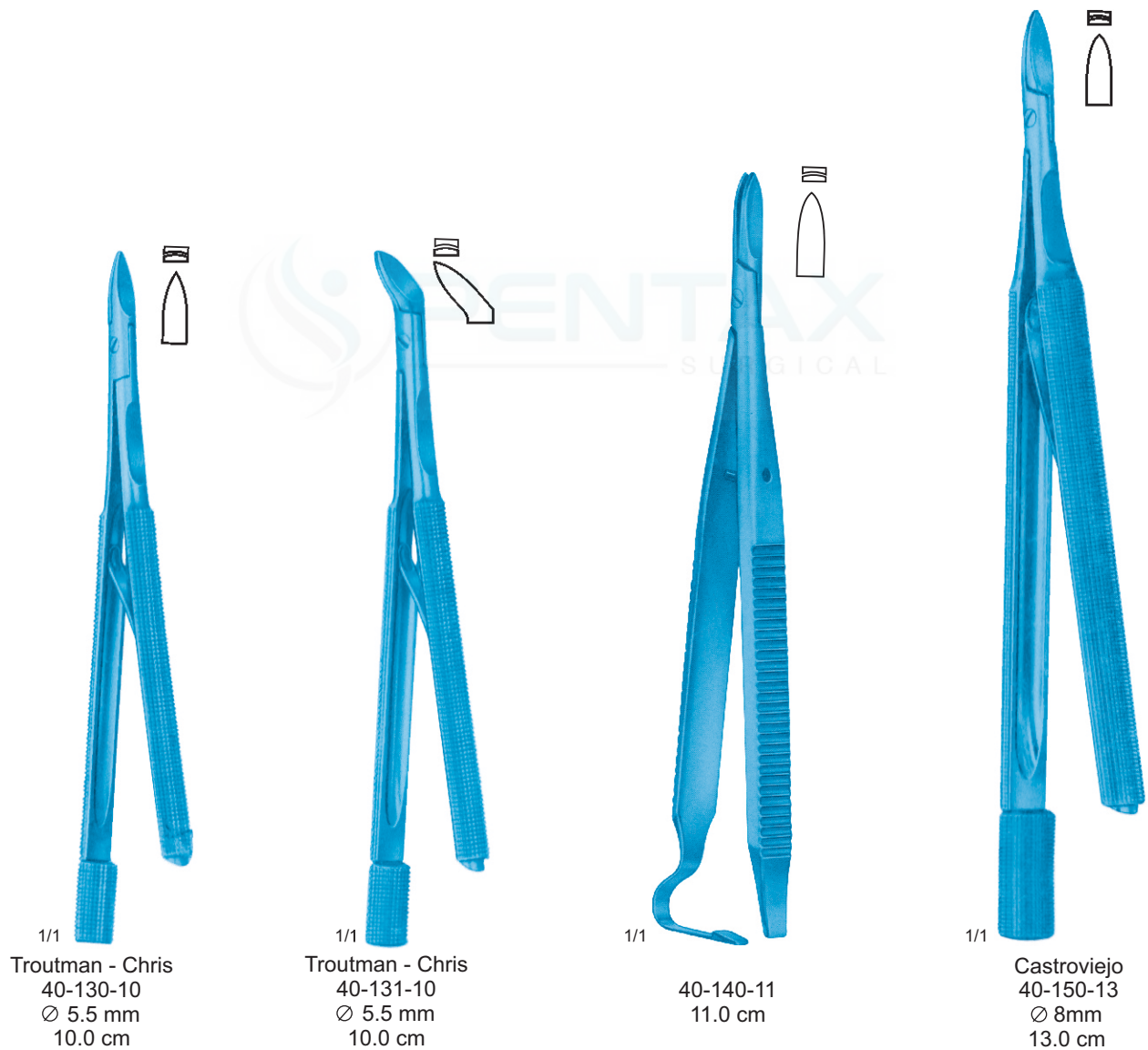



Standard

40-200-10	10.5 cm
40-200-11	11.5 cm
40-200-13	13.0 cm
40-200-14	14.5 cm
40-200-15	15.5 cm
40-200-16	16.5 cm
40-200-18	18.5 cm
40-200-20	20.0 cm

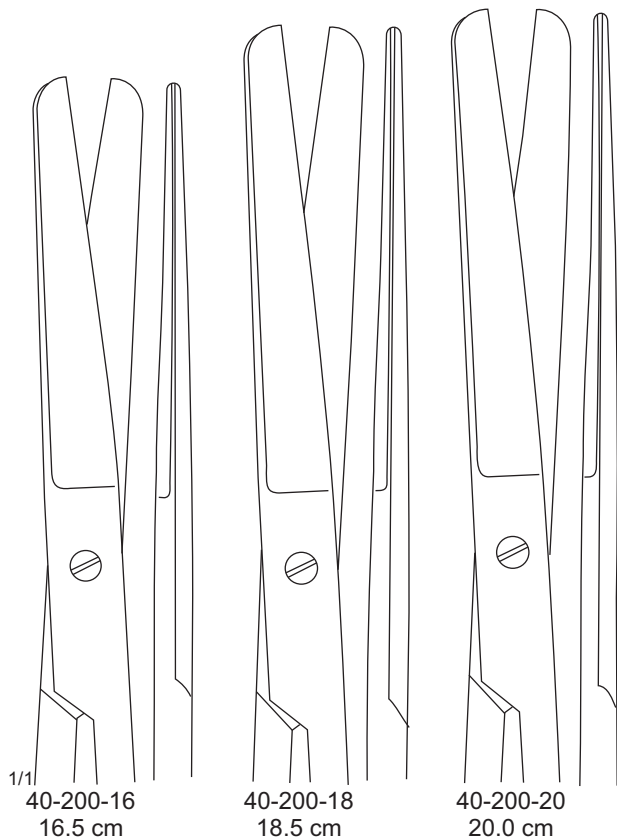
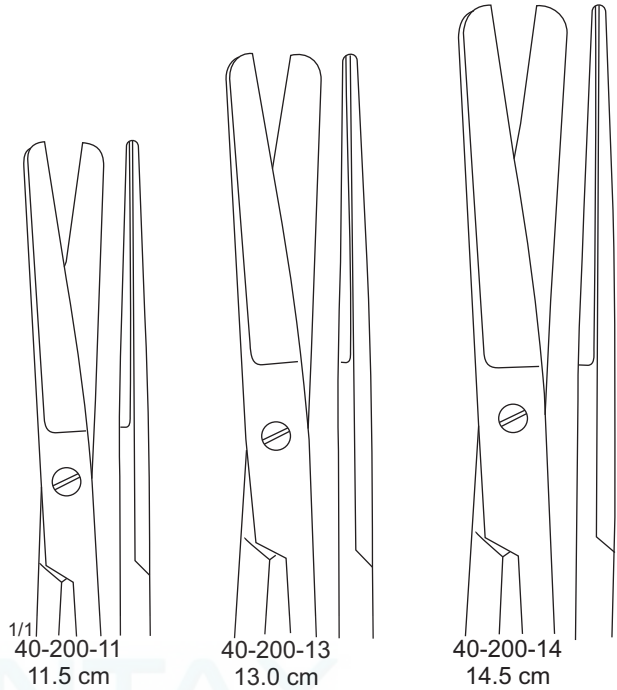



Standard

- 40-201-10 10.5 cm
- 40-201-11 11.5 cm
- 40-201-13 13.0 cm
- 40-201-14 14.5 cm
- 40-201-15 15.5 cm
- 40-201-16 16.5 cm
- 40-201-18 18.5 cm
- 40-201-20 20.0 cm

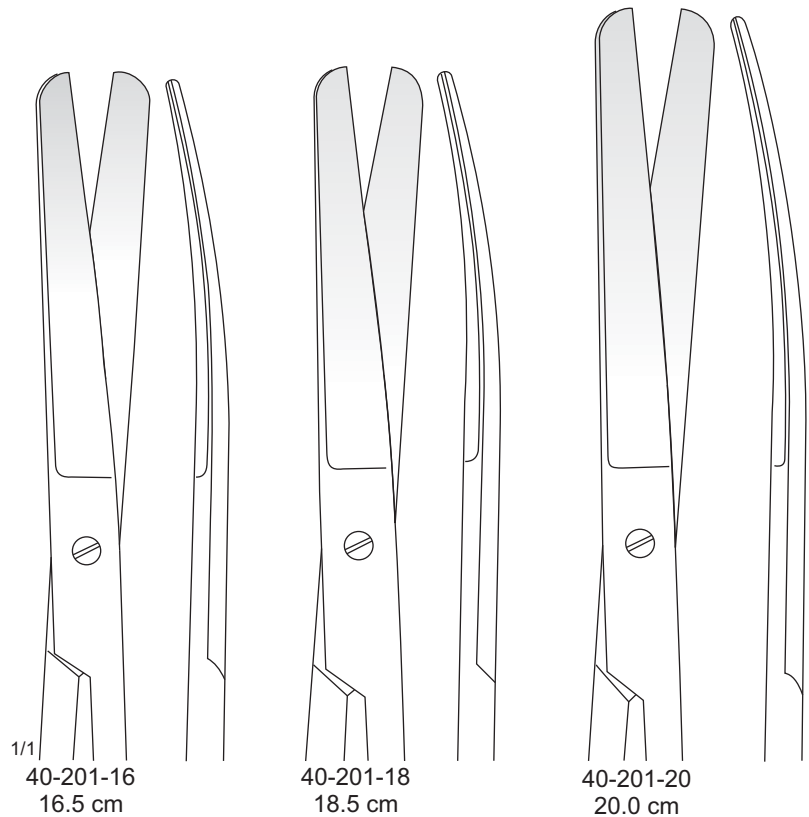
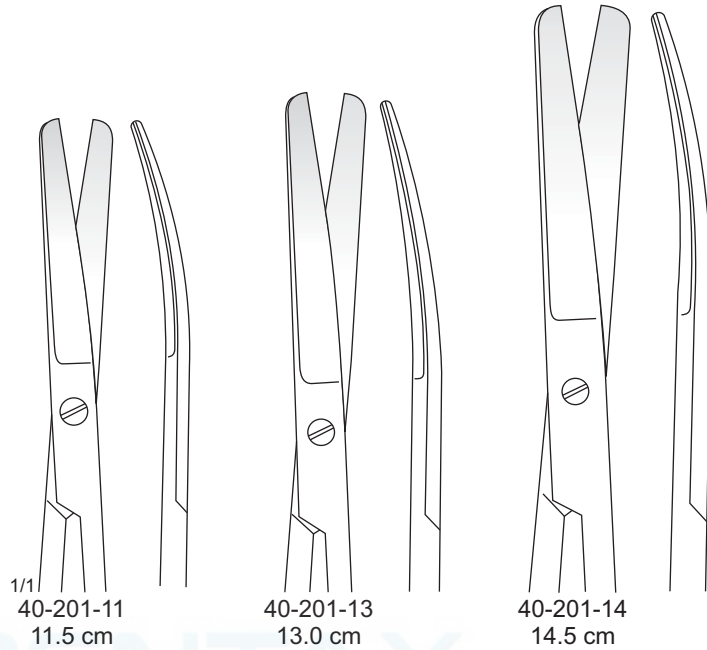



Standard

- 40-202-10 10.5 cm
- 40-202-11 11.5 cm
- 40-202-13 13.0 cm
- 40-202-14 14.5 cm
- 40-202-15 15.5 cm
- 40-202-16 16.5 cm
- 40-202-18 18.5 cm
- 40-202-20 20.0 cm

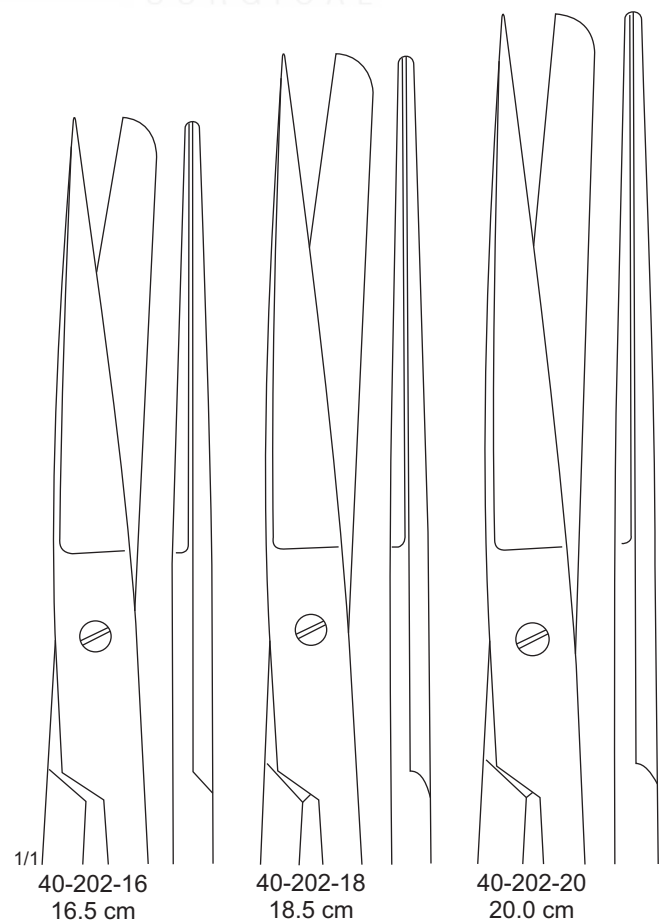
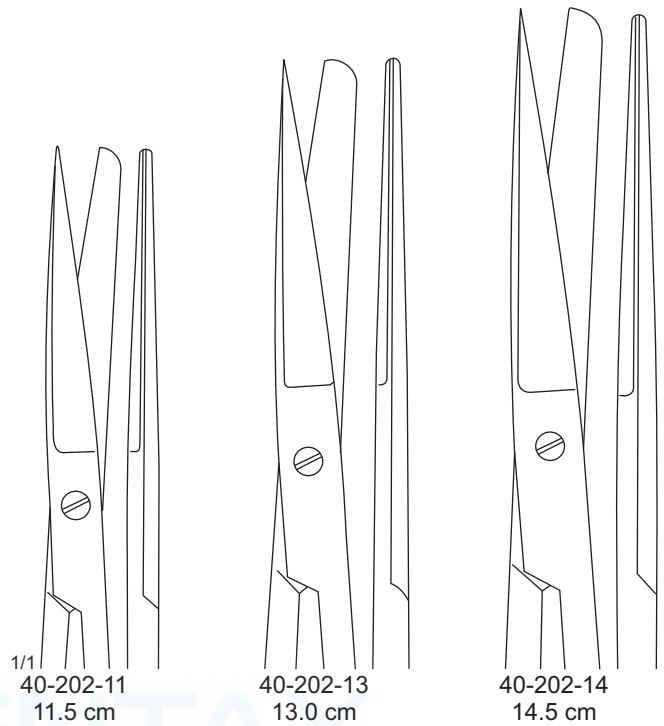



Standard

- 40-203-10 10.5 cm
- 40-203-11 11.5 cm
- 40-203-13 13.0 cm
- 40-203-14 14.5 cm
- 40-203-15 15.5 cm
- 40-203-16 16.5 cm
- 40-203-18 18.5 cm
- 40-203-20 20.0 cm

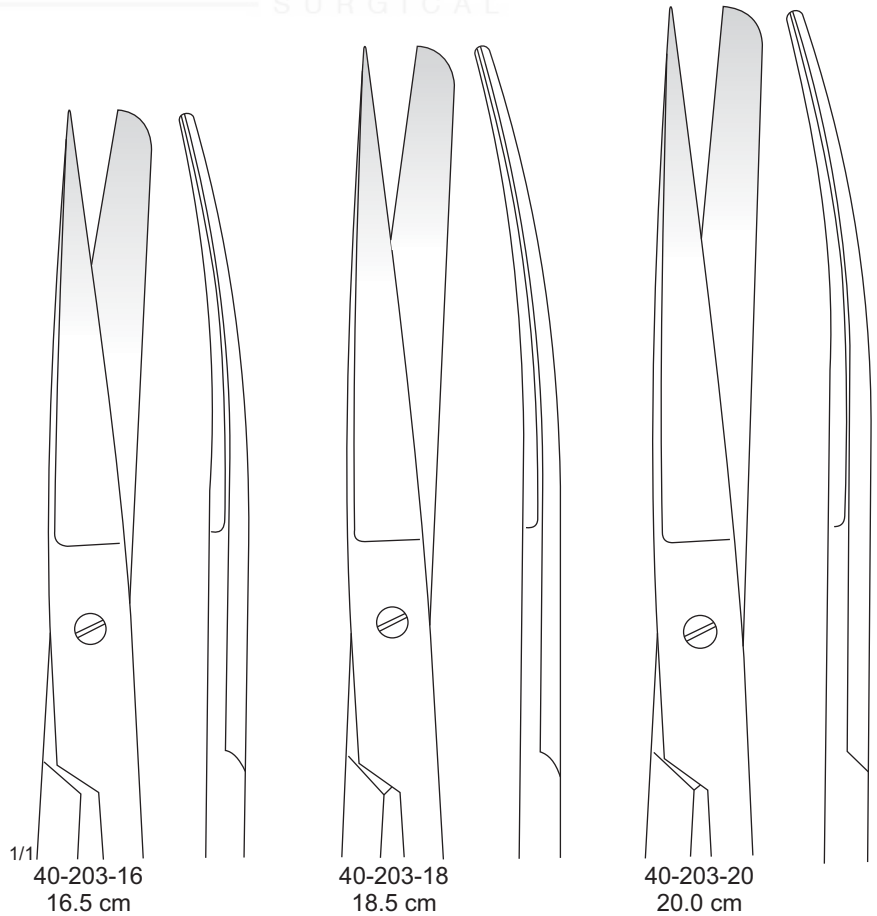
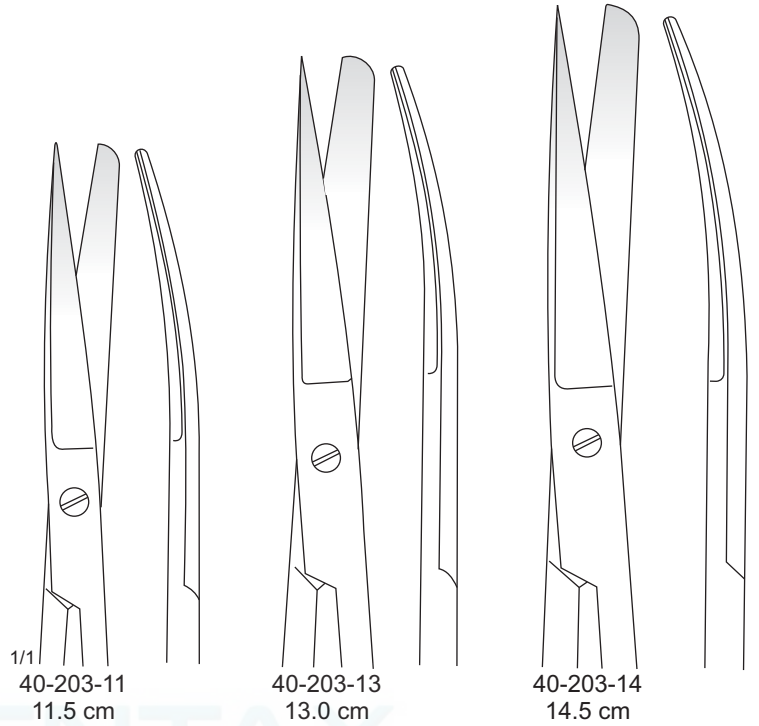



Standard

- 40-204-10 10.5 cm
- 40-204-11 11.5 cm
- 40-204-13 13.0 cm
- 40-204-14 14.5 cm
- 40-204-15 15.5 cm
- 40-204-16 16.5 cm
- 40-204-18 18.5 cm
- 40-204-20 20.0 cm

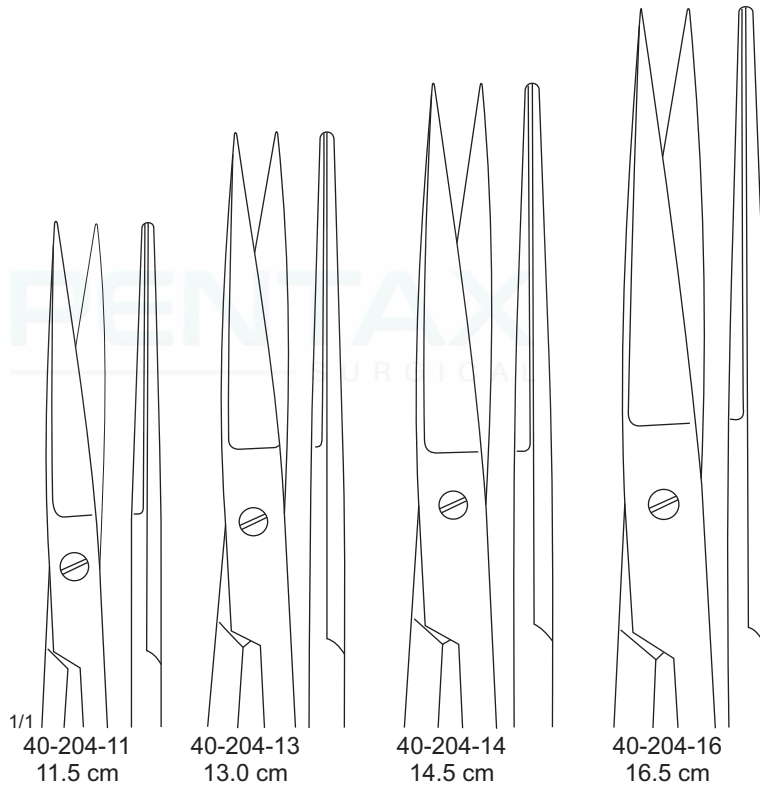



Standard

- 40-205-10 10.5 cm
- 40-205-11 11.5 cm
- 40-205-13 13.0 cm
- 40-205-14 14.5 cm
- 40-205-15 15.5 cm
- 40-205-16 16.5 cm
- 40-205-18 18.5 cm
- 40-205-20 20.0 cm

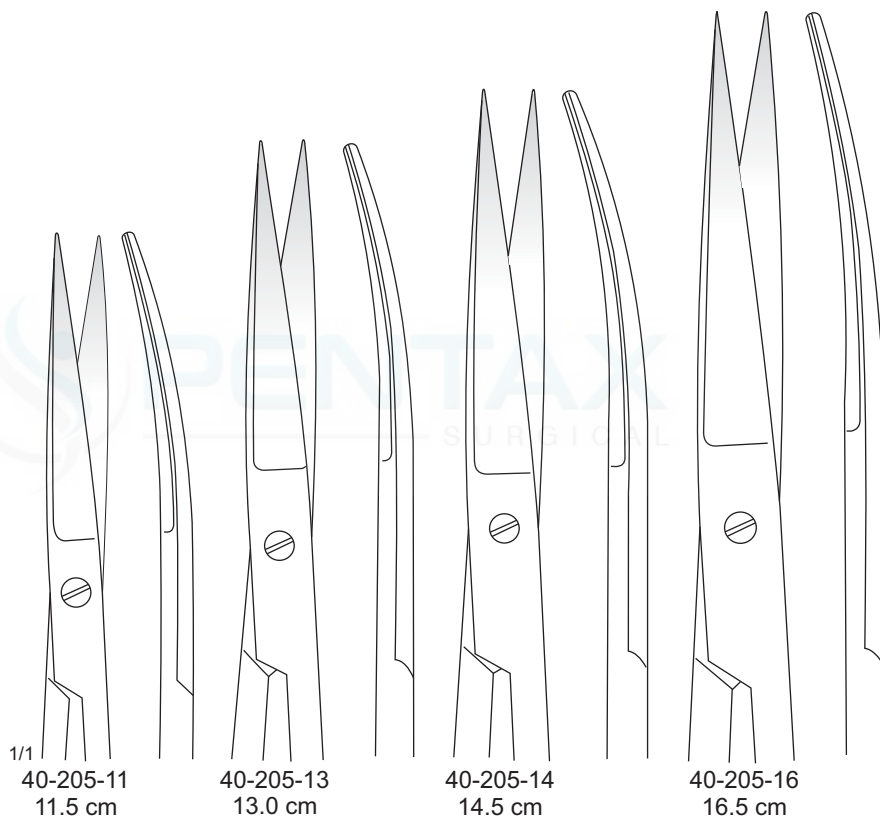



Mayo

- 40-230-14 14.5 cm
- 40-230-15 15.0 cm
- 40-230-17 17.0 cm
- 40-230-23 23.0 cm
- 40-230-28 28.0 cm
- 40-231-14 14.5 cm
- 40-231-15 15.0 cm
- 40-231-17 17.0 cm
- 40-231-23 23.0 cm
- 40-231-28 28.0 cm

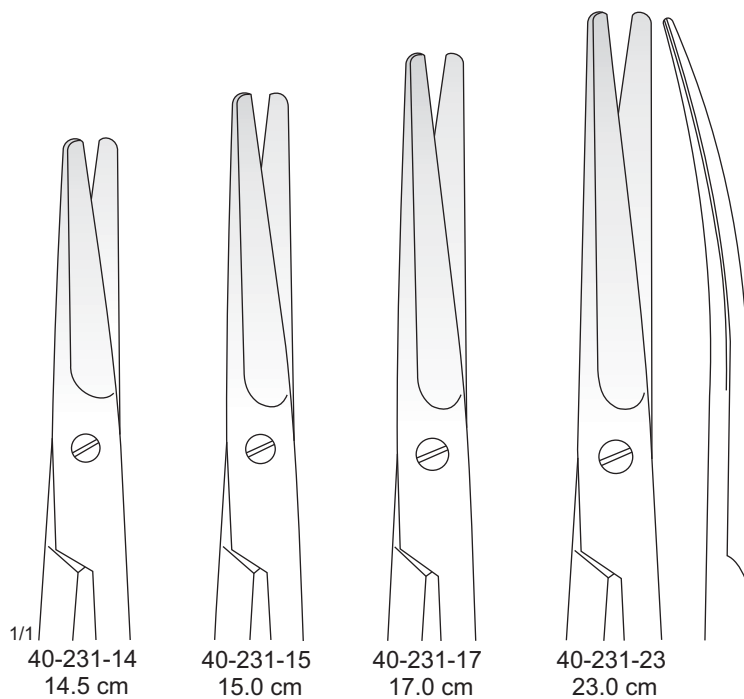
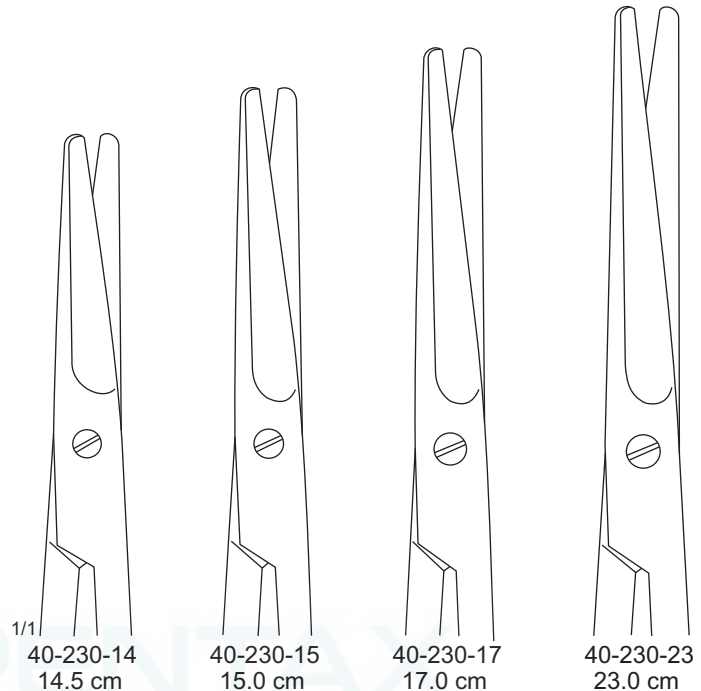

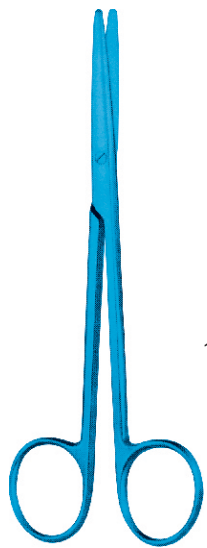

Metzenbaum
40-250-14 - 40-255-14
14.5 cm

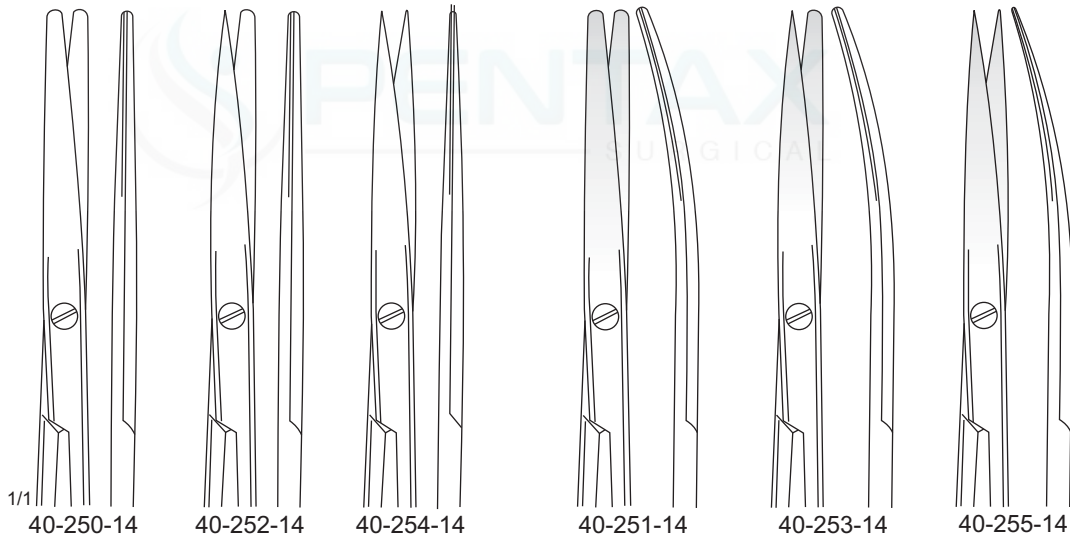



Metzenbaum - Nelson
 40-280-18 - 40-280-30

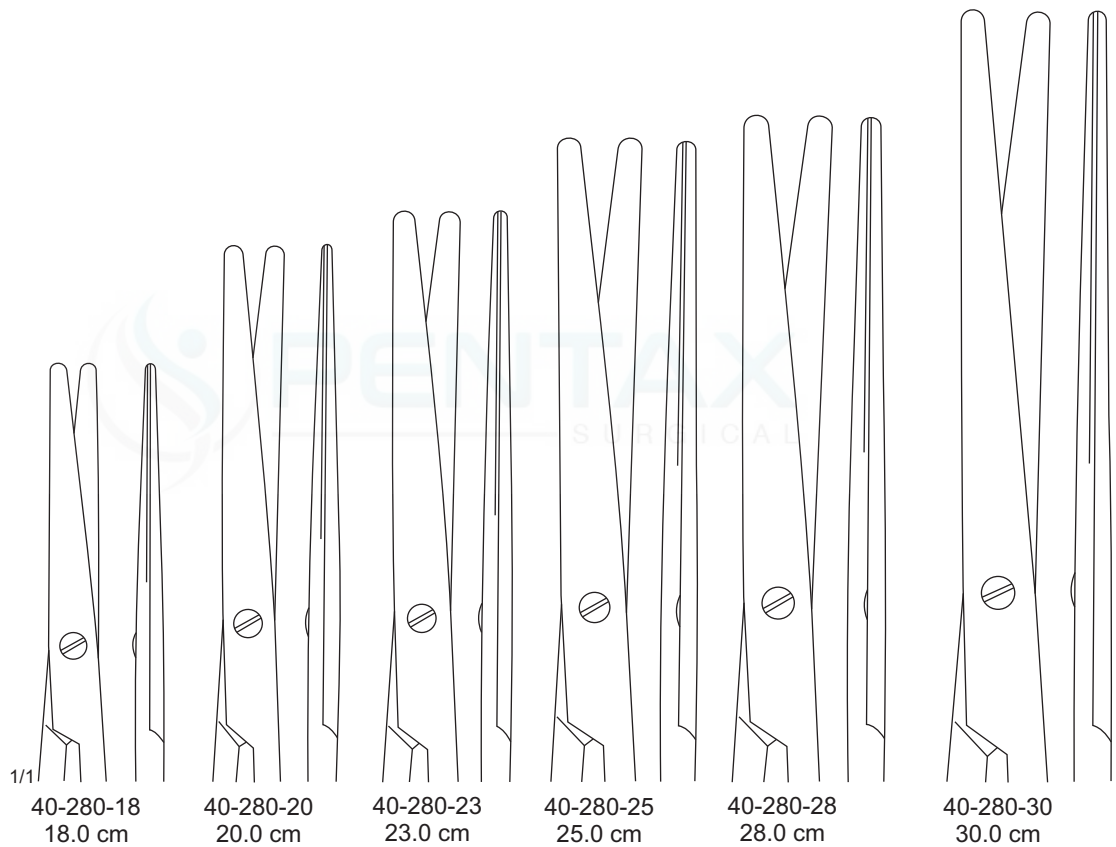

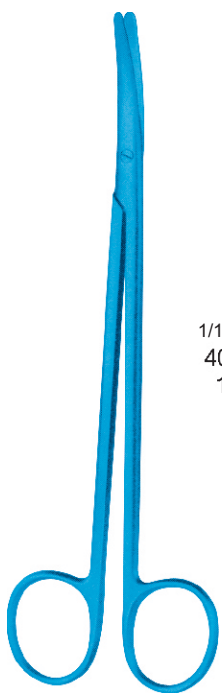

Metzenbaum - Nelson
 40-281-18 - 40-281-30

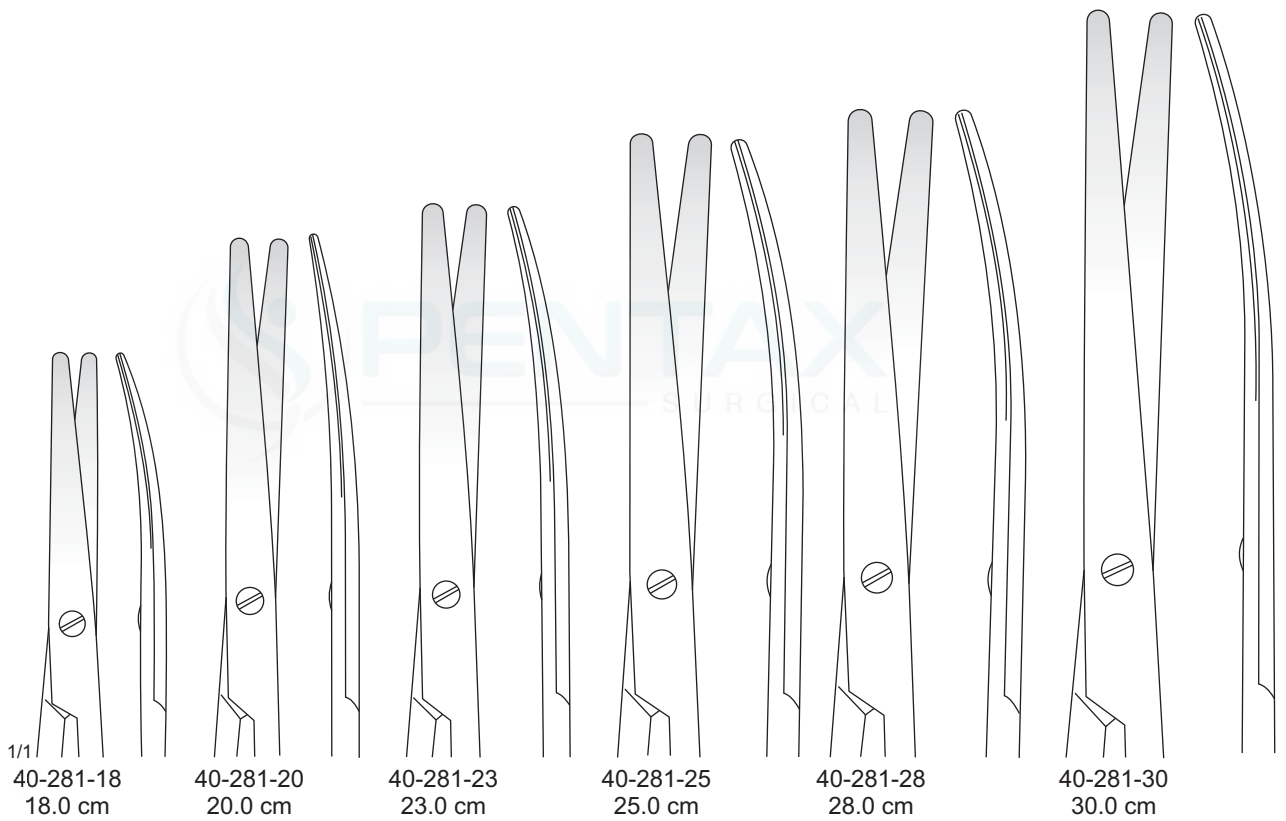

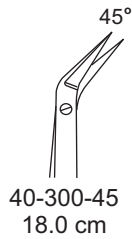
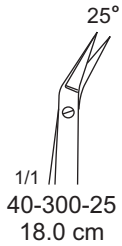

with probe
60°

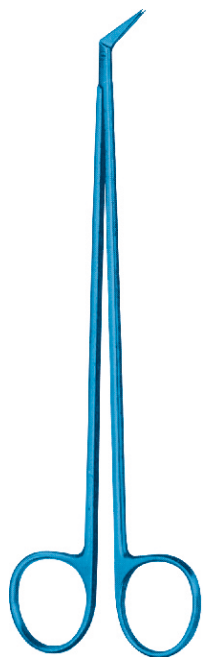
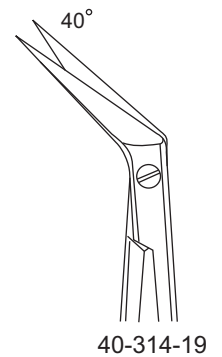
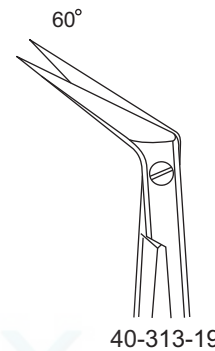
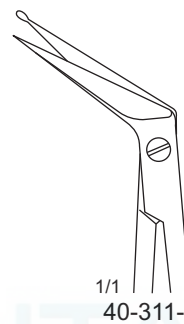

Dietrich
40-300-25 - 40-301-00

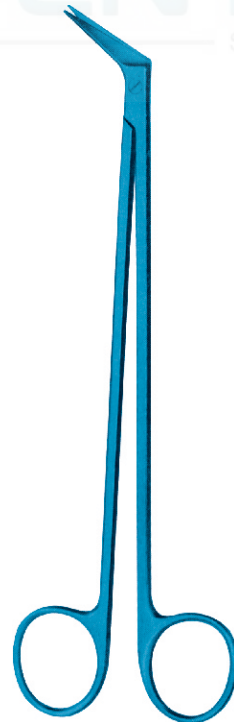

Potts - Smith
40-311-19 - 40-317-19
19.0 cm

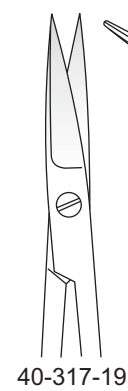
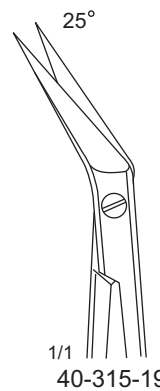

General Instruments - Instrumental general
 Eye Scissors, Iris Scissors / Titanium
 Augenscheren, Iridektomiescheren / Titan
 Tijeras oculares, Tijeras para iridectomía / Titanio

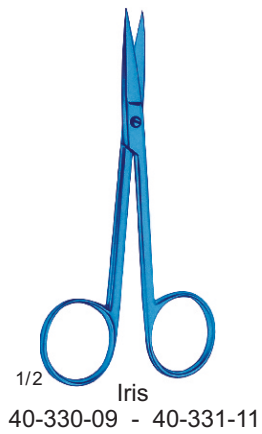
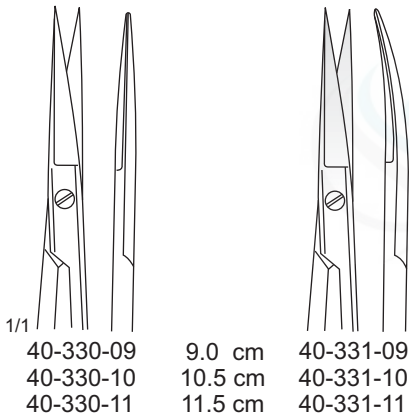

40-350-12
 40-352-12
 40-354-12



Fig. 1



Fig. 2



Fig. 3

Noyes
 12.0 cm
 Fig. 1
 Fig. 2
 Fig. 3



40-351-12
 40-353-12
 40-355-12



1/1
 Castroviejo
 40-370-02
 9.0 cm

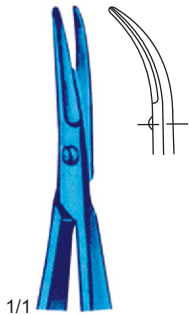

1/1
 Castroviejo
 40-370-03
 9.0 cm



1/1
 Castroviejo
 40-371-09
 9.0 cm



1/1
 Castroviejo
 40-372-09
 9.0 cm

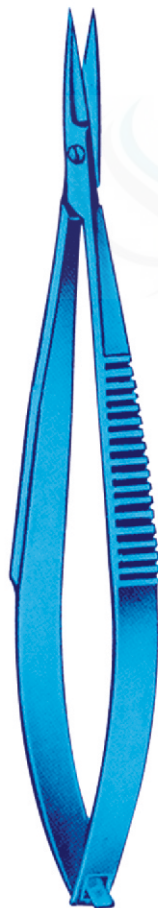

Castroviejo
 40-370-00
 9.0 cm

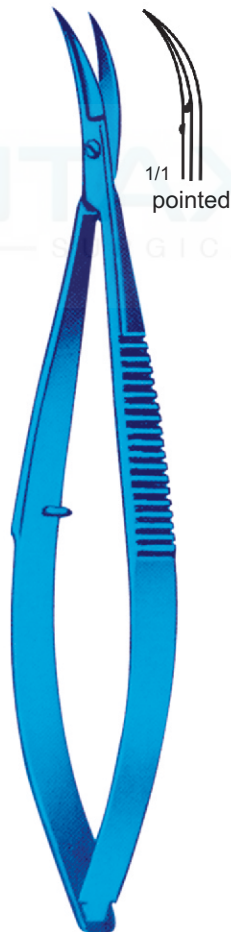

1/1
 pointed
 Castroviejo
 40-373-10
 10.0 cm

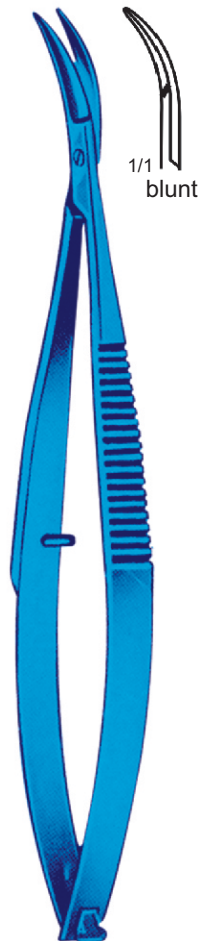

1/1
 blunt
 Castroviejo
 40-375-10
 10.0 cm

General Instruments - Instrumental general
 Secondary Cataract Scissors / Titanium
 Nachstarscheren / Titan
 Tijeras para catarata secundaria / Titanio

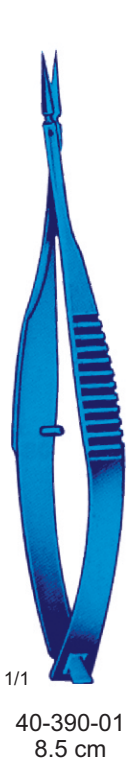

Vannas Mod. Tubingen

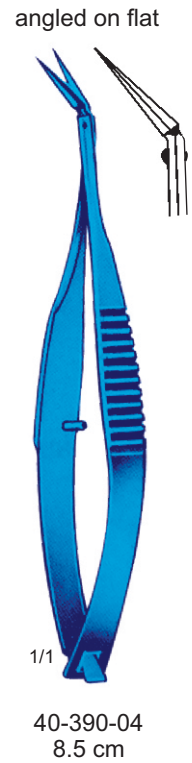
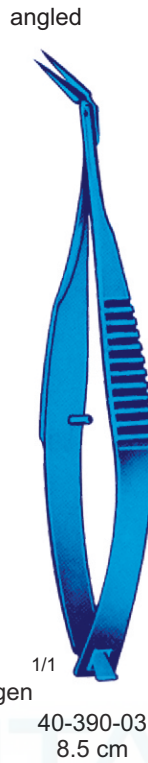

Vannas

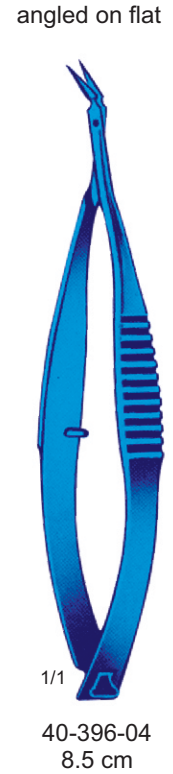
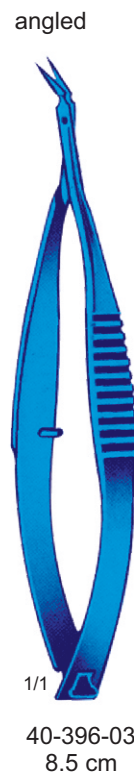

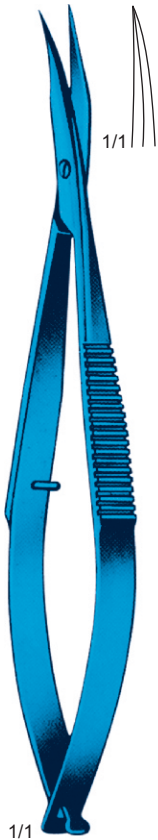
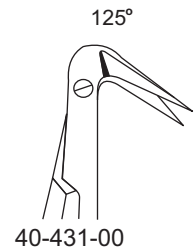
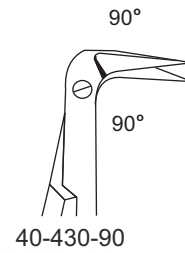
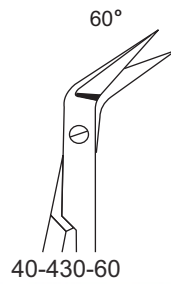
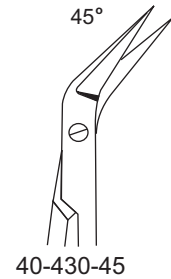
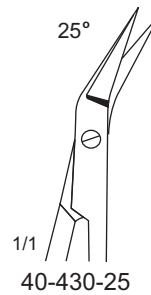

Westcott
40-410-11
11.0 cm

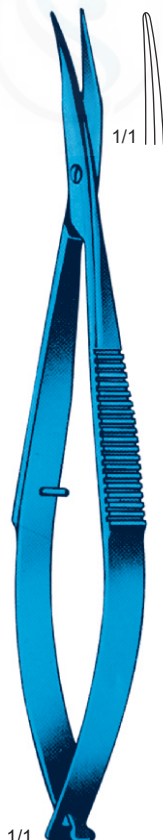

Westcott
40-411-11
11.0 cm

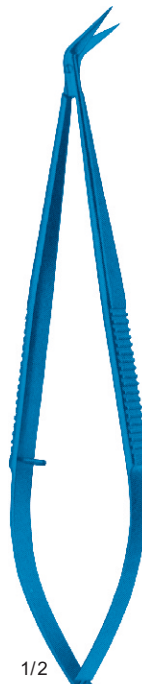

40-430-25 - 40-431-00
18.0 cm

General Instruments - Instrumental general
 Dressing Forceps / Titanium
 Anatomische Pinzetten / Titan
 Pinzas de disección / Titanio



Standard
 40-500-10 - 40-500-25

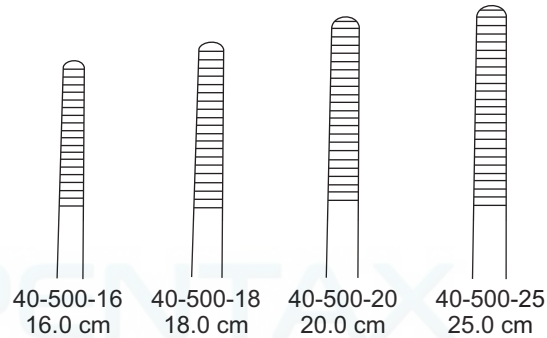
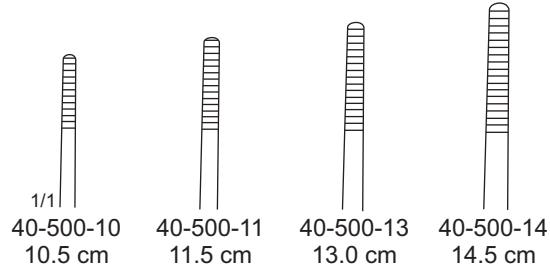

Narrow
 40-510-11 - 40-510-25

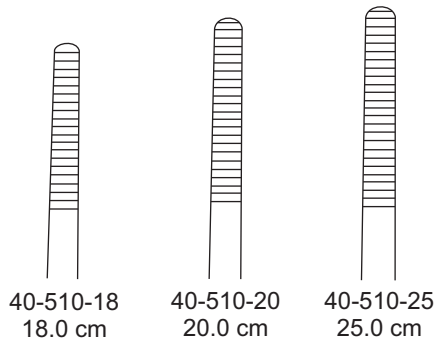
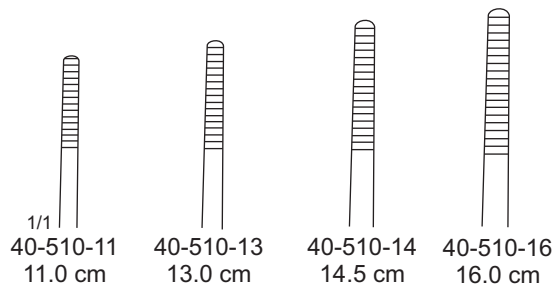

Adson
 40-522-12 40-522-15

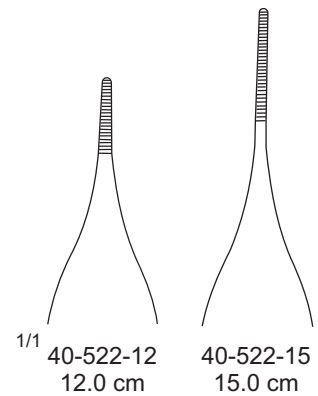

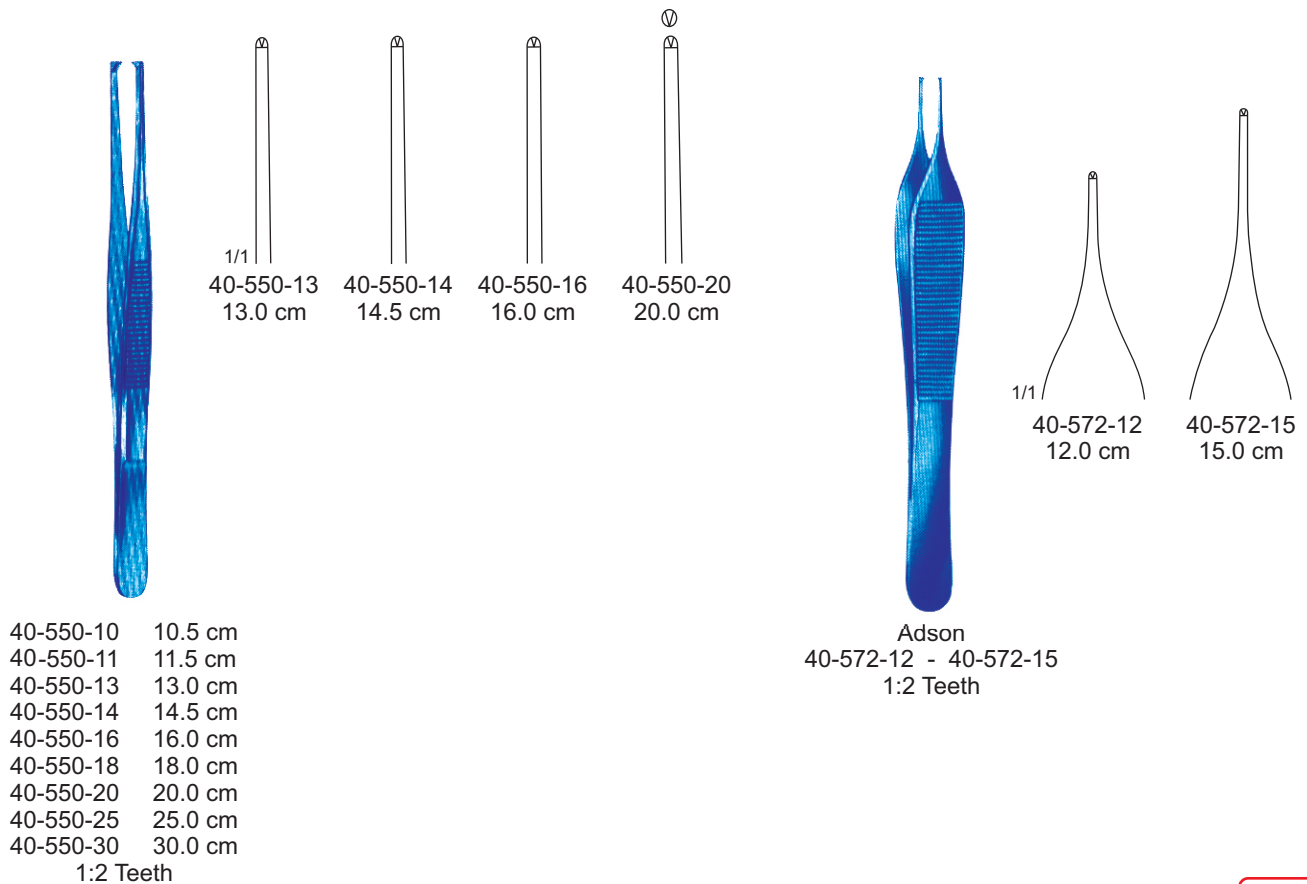
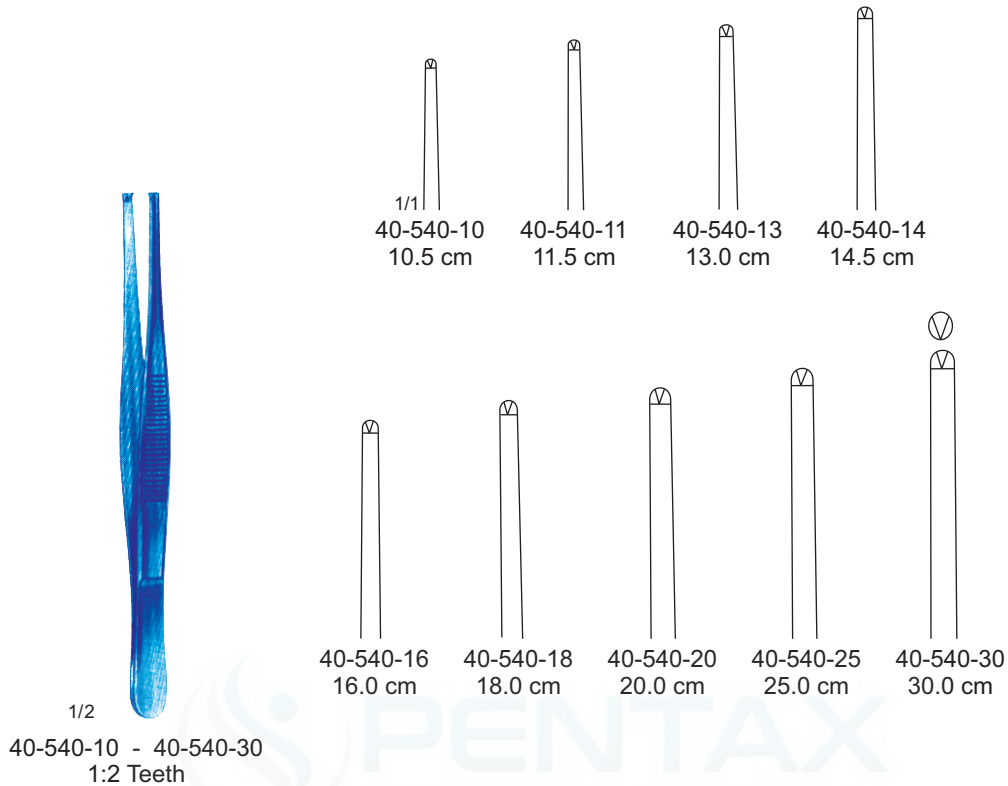

- 40-550-10 10.5 cm
 - 40-550-11 11.5 cm
 - 40-550-13 13.0 cm
 - 40-550-14 14.5 cm
 - 40-550-16 16.0 cm
 - 40-550-18 18.0 cm
 - 40-550-20 20.0 cm
 - 40-550-25 25.0 cm
 - 40-550-30 30.0 cm
- 1:2 Teeth

- Adson
 40-572-12 - 40-572-15
 1:2 Teeth



Russ. Modell
40-600-15 40-600-25

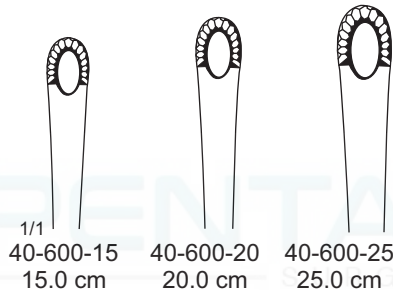



40-620-01
11.5 cm



40-620-02
11.0 cm



40-620-03
11.0 cm



40-620-04
11.5 cm



40-620-05
10.5 cm



40-620-06
10.5 cm



40-620-07
11.5 cm



40-620-08
11.5 cm



40-620-09
11.5 cm



40-620-10
10.5 cm



40-620-11
10.5 cm



40-620-12
12.5 cm



40-620-13
12.5 cm

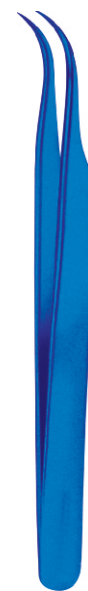

40-620-14
12.5 cm



40-631-22
Ø 3.0 mm

40-633-22
Ø 5.0 mm

1/2
Yasargil
40-631-22 - 40-633-22



40-635-22
Ø 3.0 mm

40-637-22
Ø 5.0 mm

1/2
Yasargil
40-635-22 - 40-637-22



40-639-22
Ø 3.0 mm

40-639-22
Ø 5.0 mm

1/2
Heifetz
40-639-22 - 40-641-22

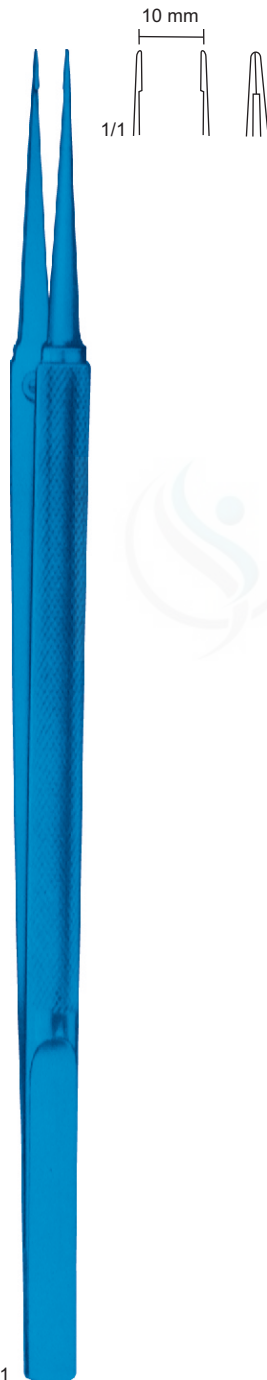

1/1
 Gomel
 40-660-01
 16.0 cm



1/1
 Gomel
 40-660-06
 16.0 cm
 1:2 Teeth

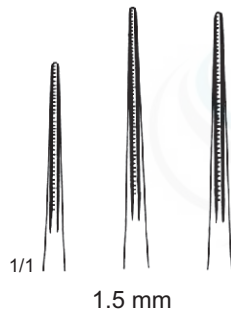

De Bakey
 40-670-16 16.0 cm
 40-670-20 20.0 cm
 40-670-24 24.0 cm



De Bakey
 40-672-16 16.0 cm
 40-672-20 20.0 cm
 40-672-24 24.0 cm
 40-672-30 30.0 cm

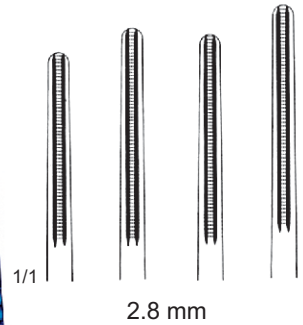

De Bakey
 40-674-16 16.0 cm
 40-674-20 20.0 cm
 40-674-24 24.0 cm
 40-674-30 30.0 cm

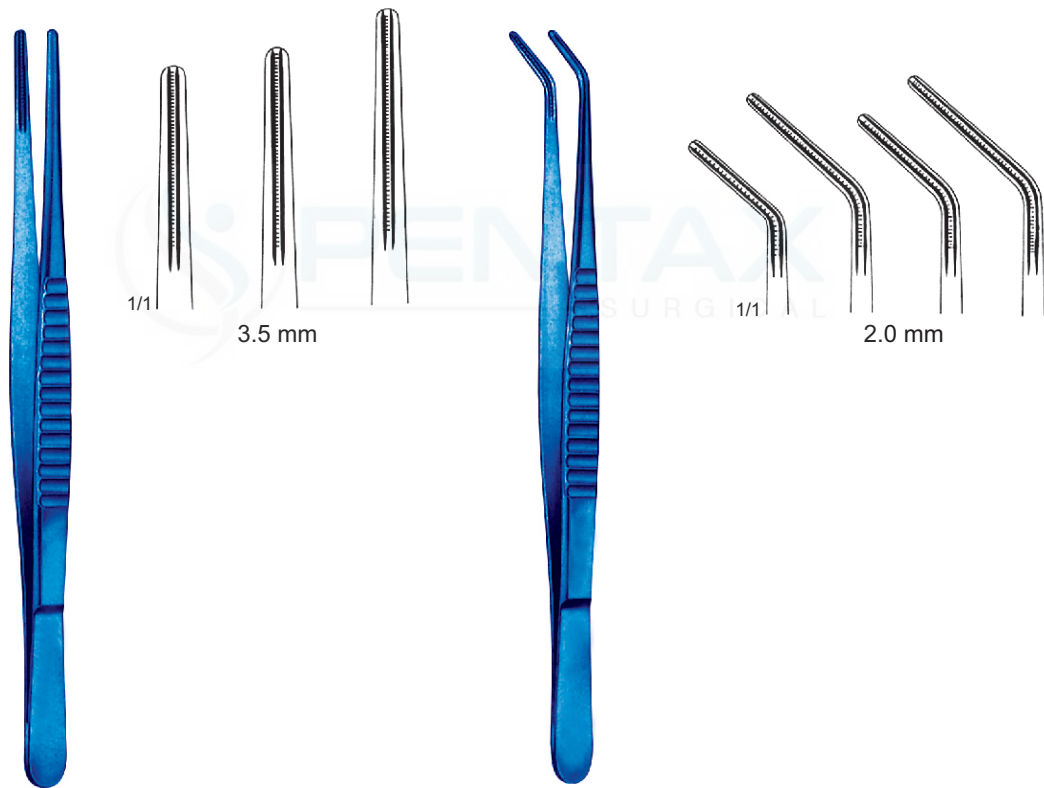

De Bakey
 40-676-20 20.0 cm
 40-676-24 24.0 cm
 40-676-30 30.0 cm

De Bakey
 40-679-16 16.0 cm
 40-679-20 20.0 cm
 40-679-24 24.0 cm
 40-679-30 30.0 cm

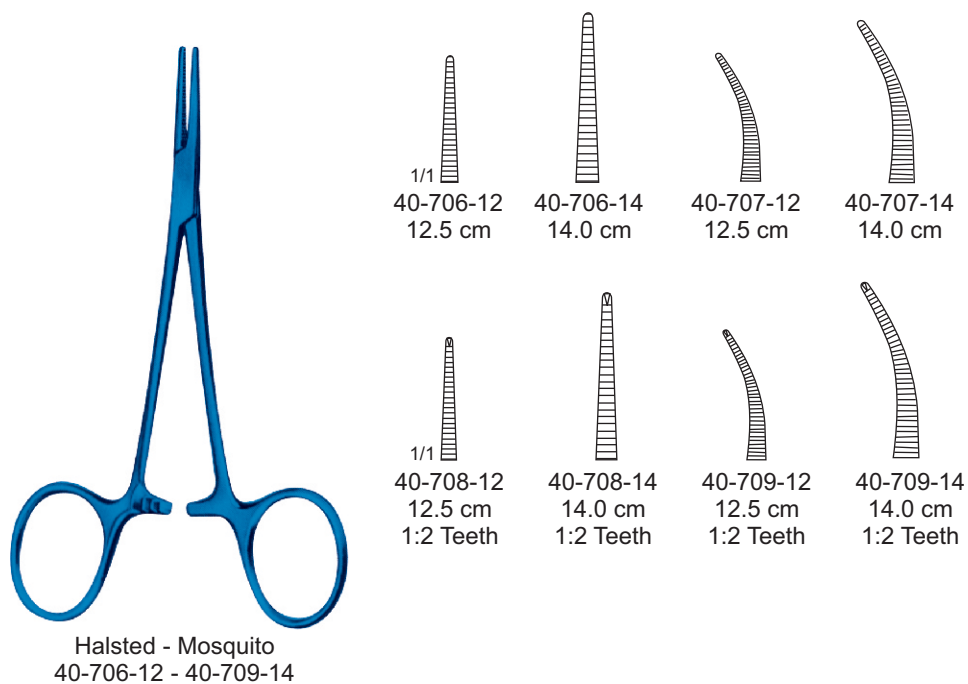
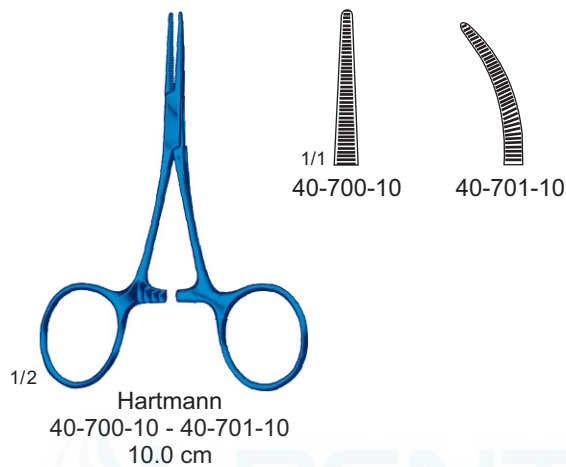

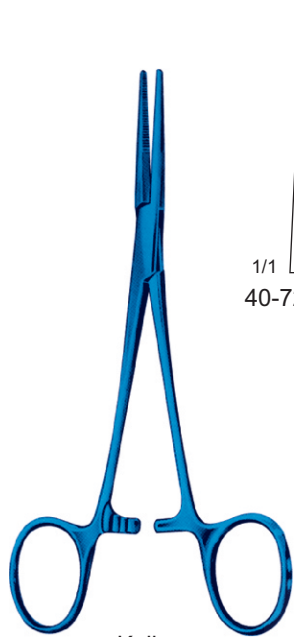

Kelly
 40-720-14 - 40-721-14
 14.0 cm

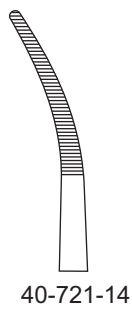
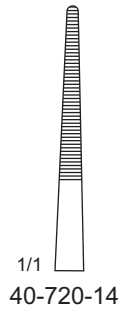

Kelly - Rankin
 40-726-16 - 40-727-16
 16.0 cm

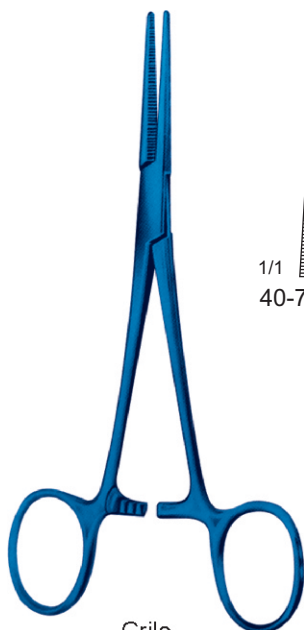
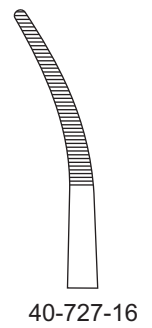
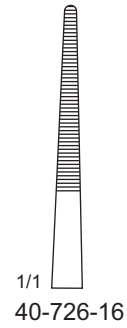

Crile
 40-750-14 - 40-751-14
 14.0 cm

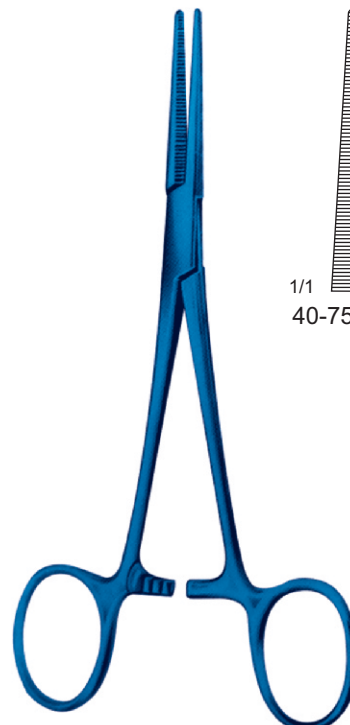
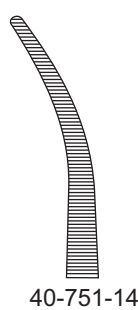
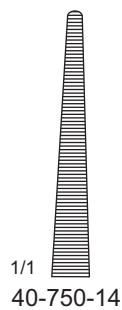

Crile - Rankin
 40-756-16 - 40-757-16
 16.0 cm

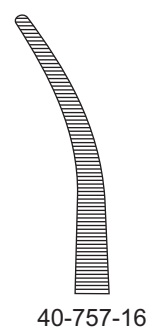
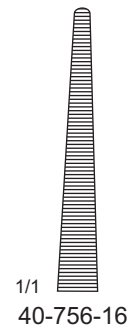

General Instruments - Instrumental general
 Artery Forceps / Titanium
 Arterienklemmen / Titan
 Pinzas hemostáticas / Titanio

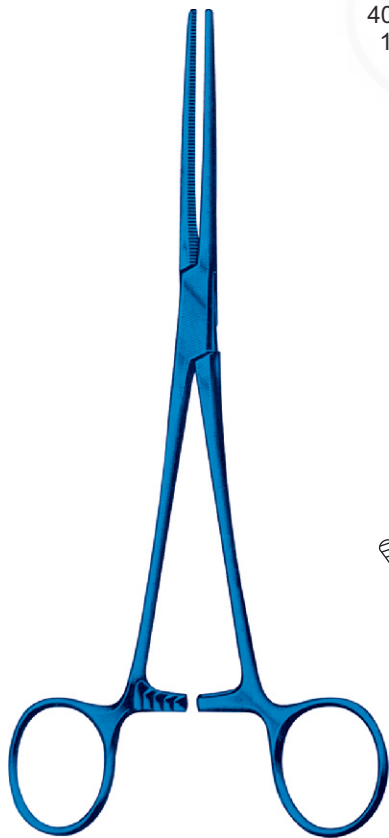
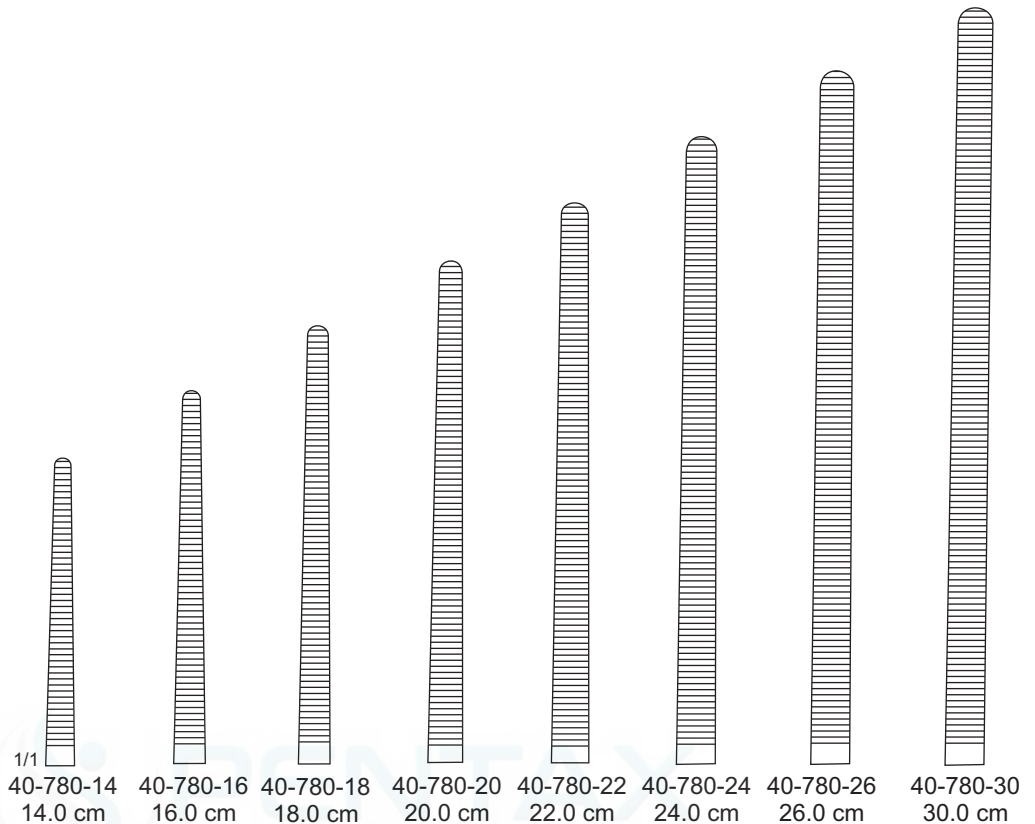

Rochester Pean
 40-780-14 - 40-781-30

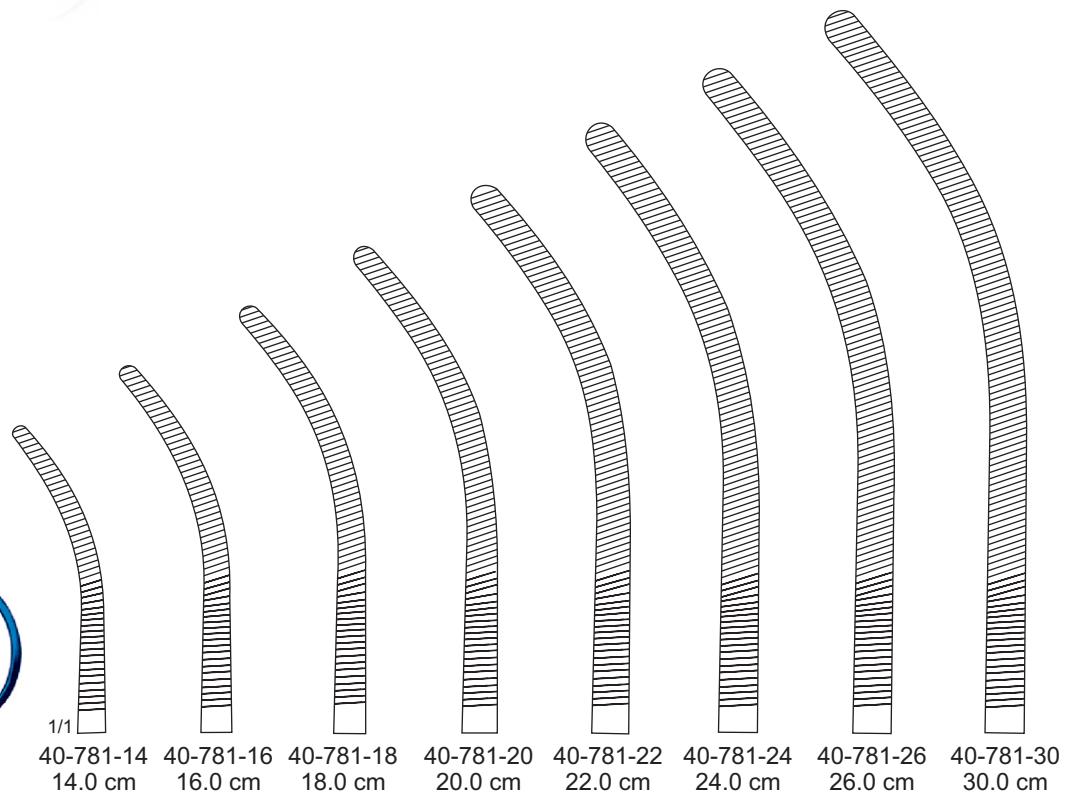

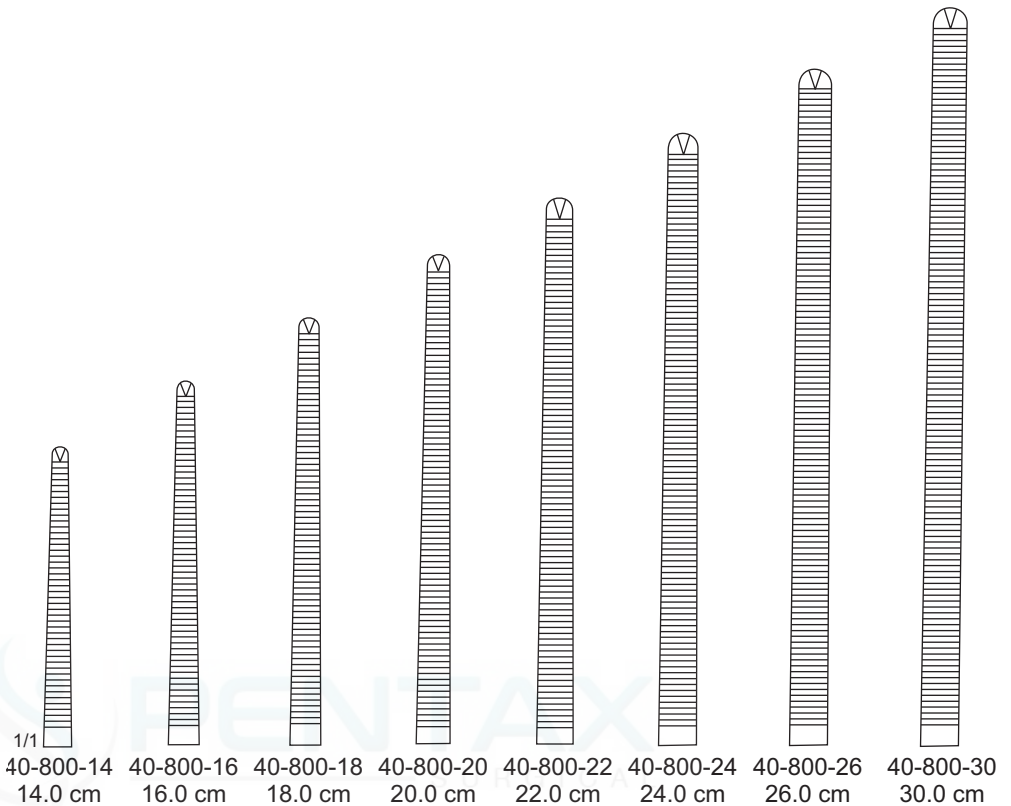

Kocher (Ochsner)
 40-800-14 - 40-801-30
 1:2 Teeth

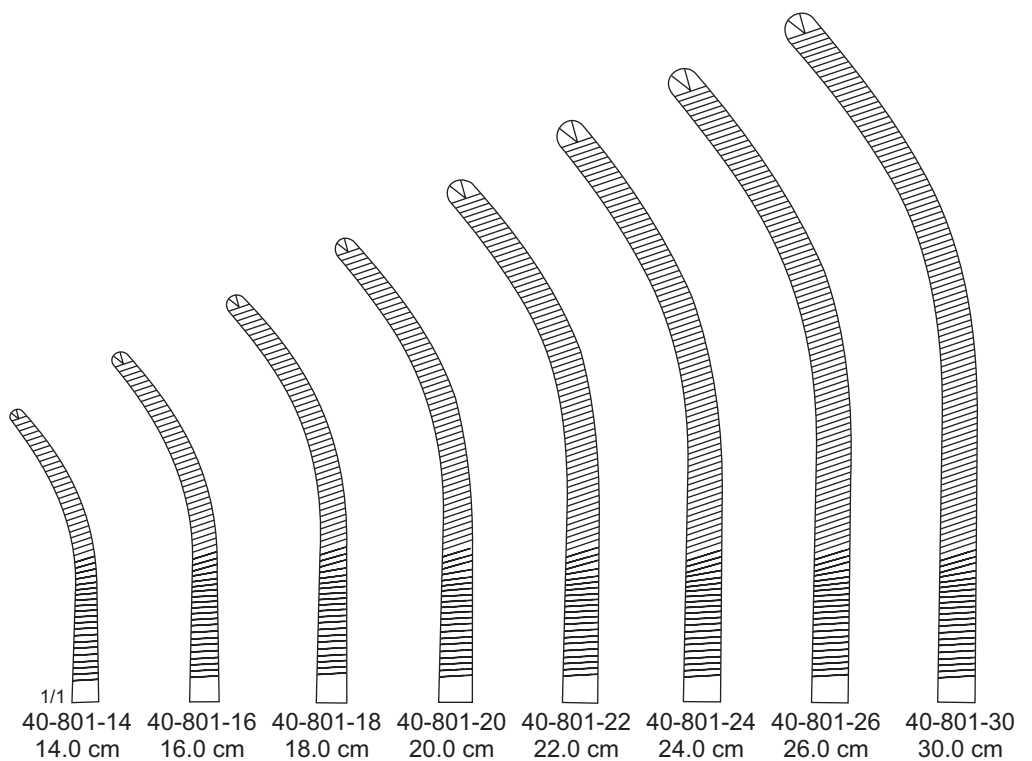

Suture - Naht - Sutura
 Micro - Needle Holders / Titanium
 Mikro - Nadelhalter / Titan
 Micro - porta - agujas / Titanio

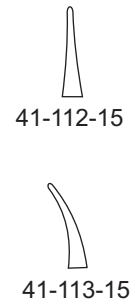
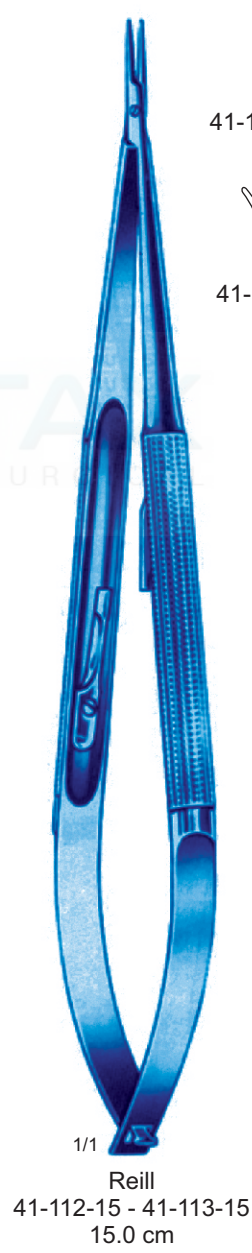
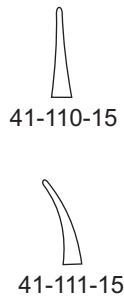
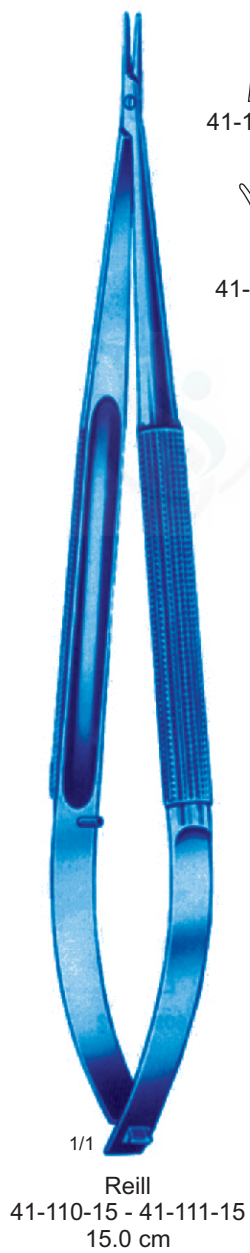

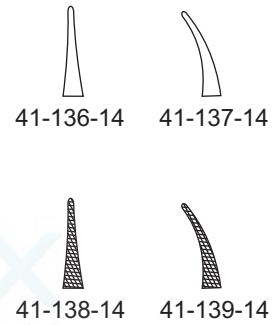
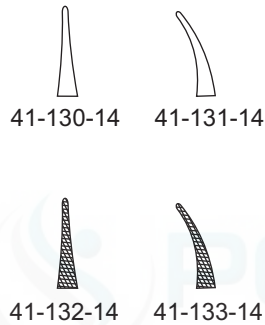

Suture - Naht - Sutura
 Needle Holders / Titanium
 Nadelhalter / Titan
 Porta - agujas / Titanio

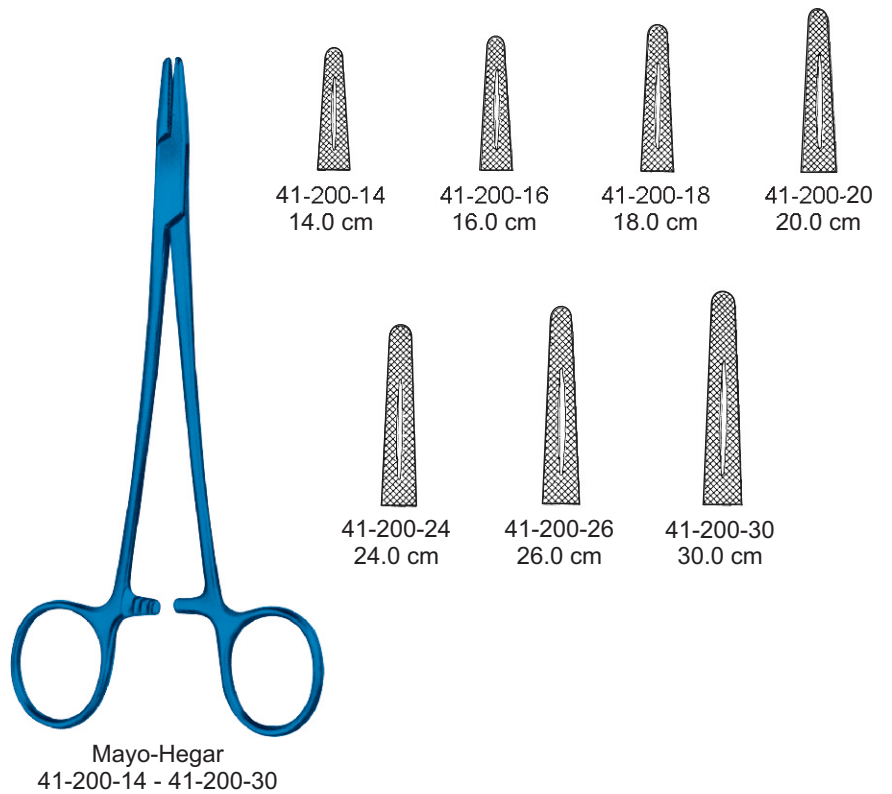
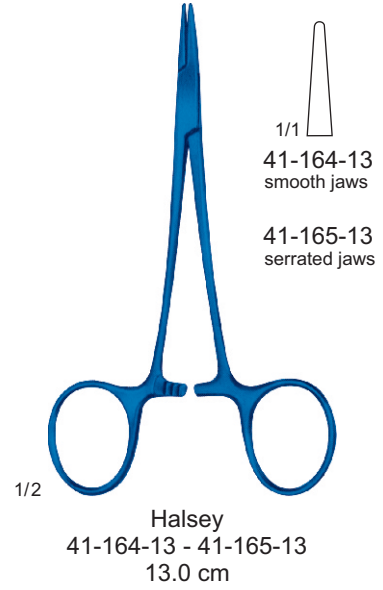
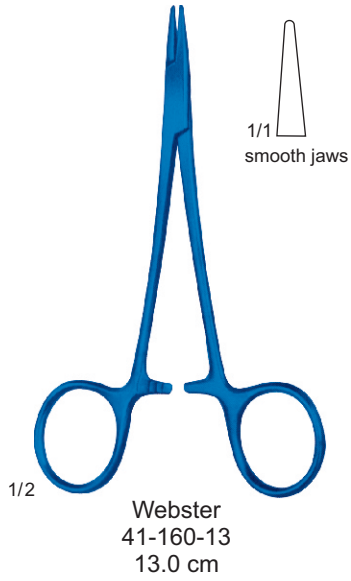

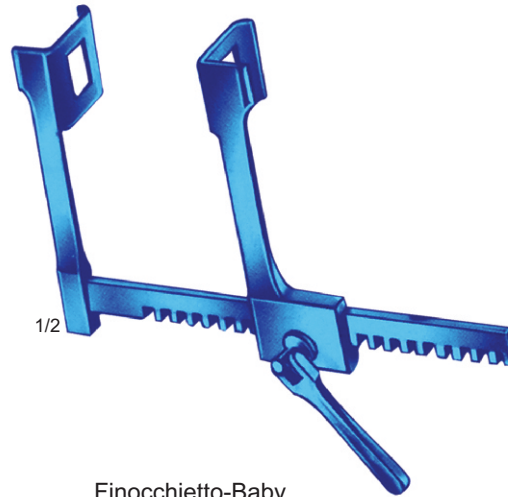
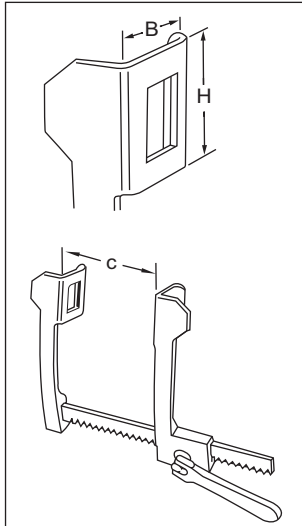

Finocchietto-Baby
 41-250-75
 B=14.0 mm H=15.0 mm C=75.0 mm



Finocchietto
 41-254-01 B=30.0 mm H=45.0 mm C=150.0 mm
 41-254-02 B=46.0 mm H=62.0 mm C=190.0 mm
 41-254-03 B=80.0 mm H=65.0 mm C=190.0 mm

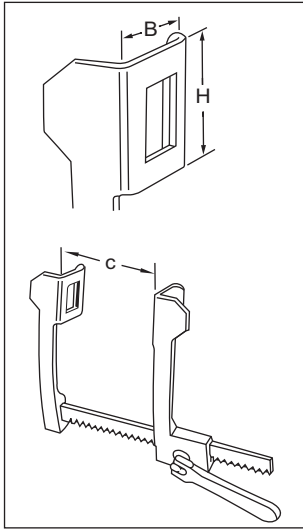

41-258-01
 B=17.0 mm H=22.0 mm C=160.0 mm



Finocchietto-Infant
 41-262-01
 B=15.0 mm H=15.0 mm C=75.0 mm

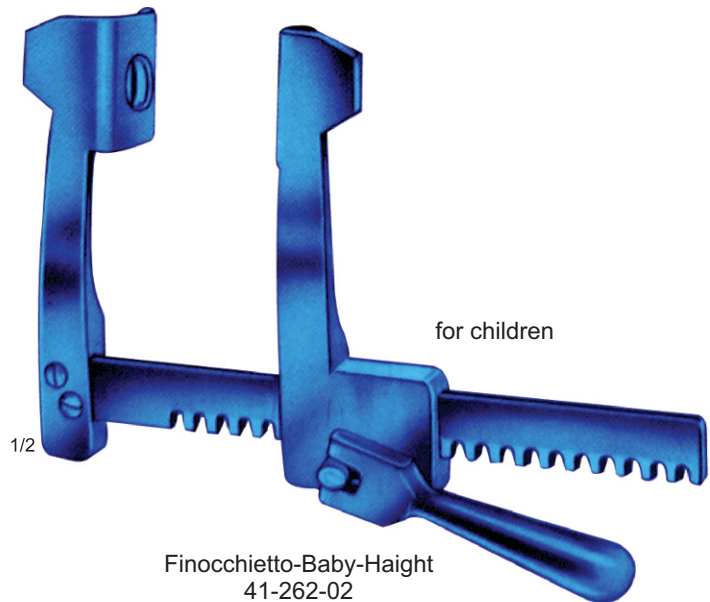

Finocchietto-Baby-Haight
 41-262-02
 B=31.0 mm H=31.0 mm C=100.0 mm

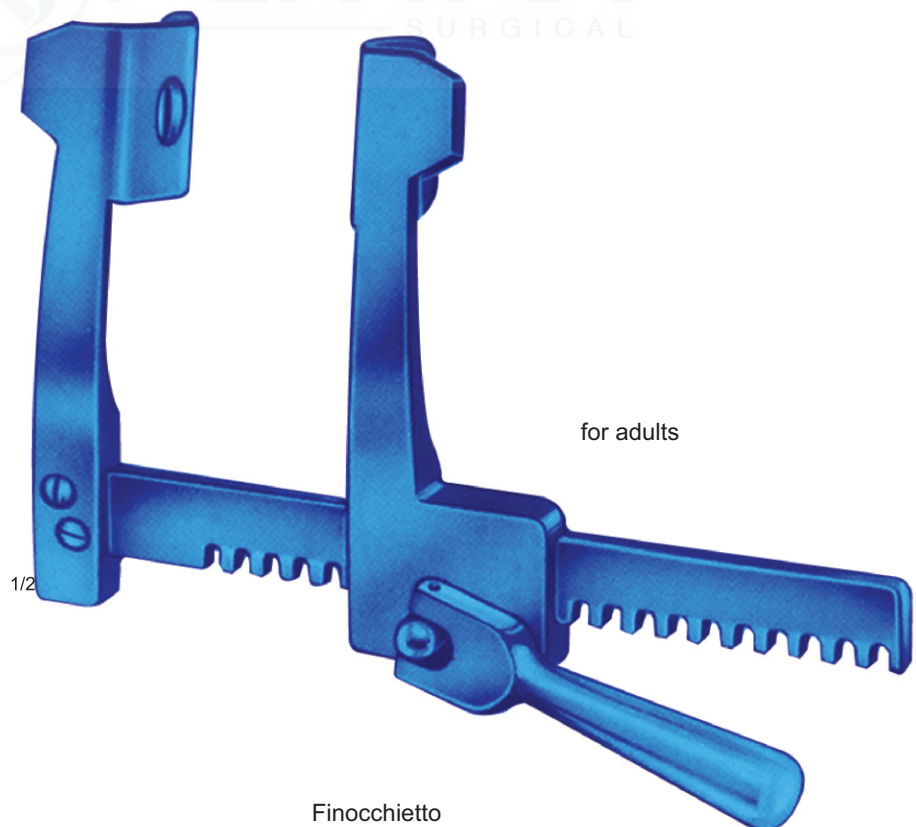
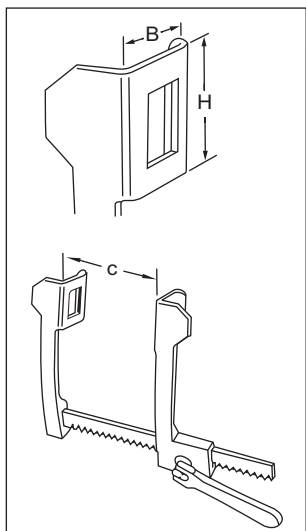

Finocchietto
 41-262-03 B=40.0 mm H=45.0 mm C=135.0 mm
 41-262-04 B=52.0 mm H=62.0 mm C=175.0 mm
 41-262-05 B=84.0 mm H=65.0 mm C=175.0 mm

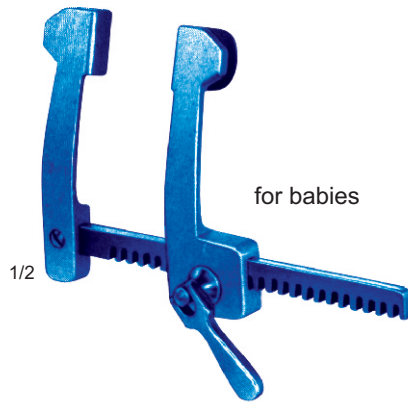

for babies

1/2
 Cooley
 41-266-01
 B=12.0 mm H=16.0 mm C=95.0 mm

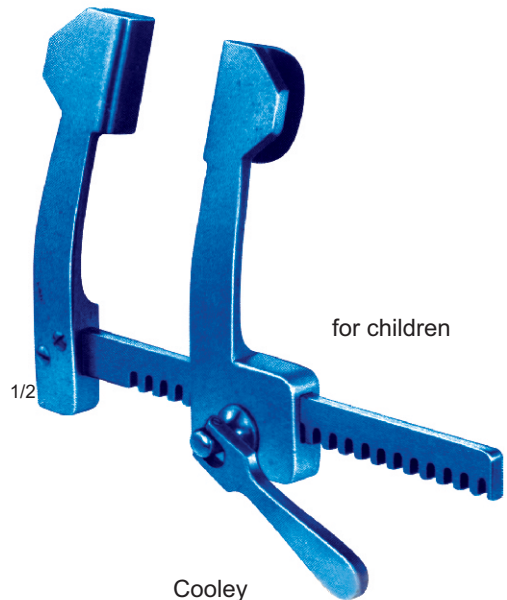

for children

1/2
 Cooley
 41-266-02 B=15.0 mm H=30.0 mm C=140.0 mm
 41-266-03 B=21.0 mm H=44.0 mm C=150.0 mm

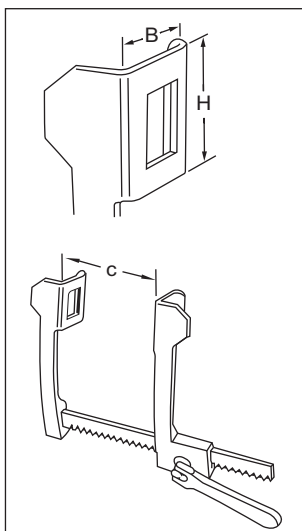

for adults

1/2
 Cooley
 41-266-04
 B=35.0 mm H=50.0 mm C=200.0 mm



for babies

Castaneda
 41-270-01
 B=10.5 mm H=32.0 mm C=65.0 mm

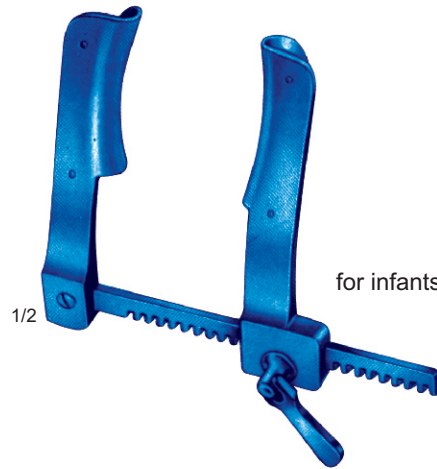

for infants

Castaneda
 41-270-02
 B=12.0 mm H=45.0 mm C=70.0 mm

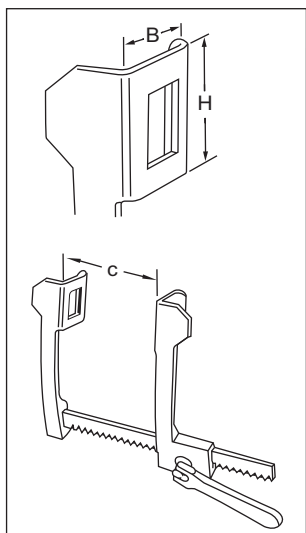

for children

Castaneda
 41-270-03
 B=15.0 mm H=60.0 mm C=120.0 mm

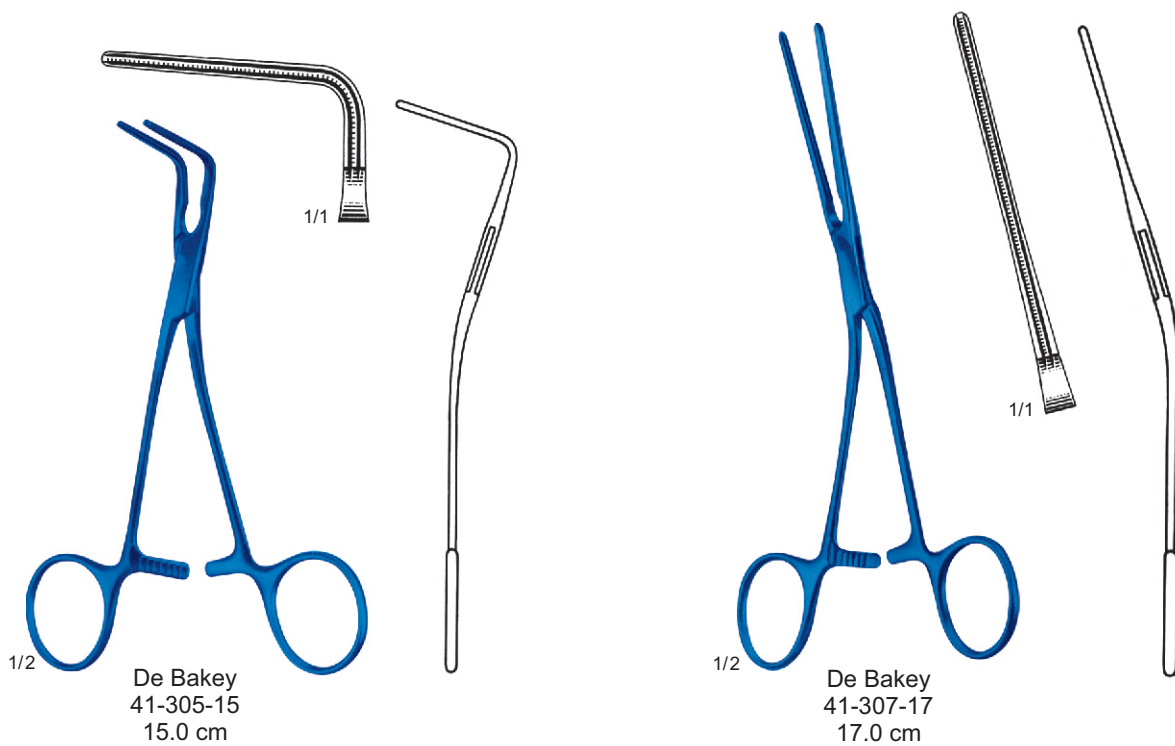
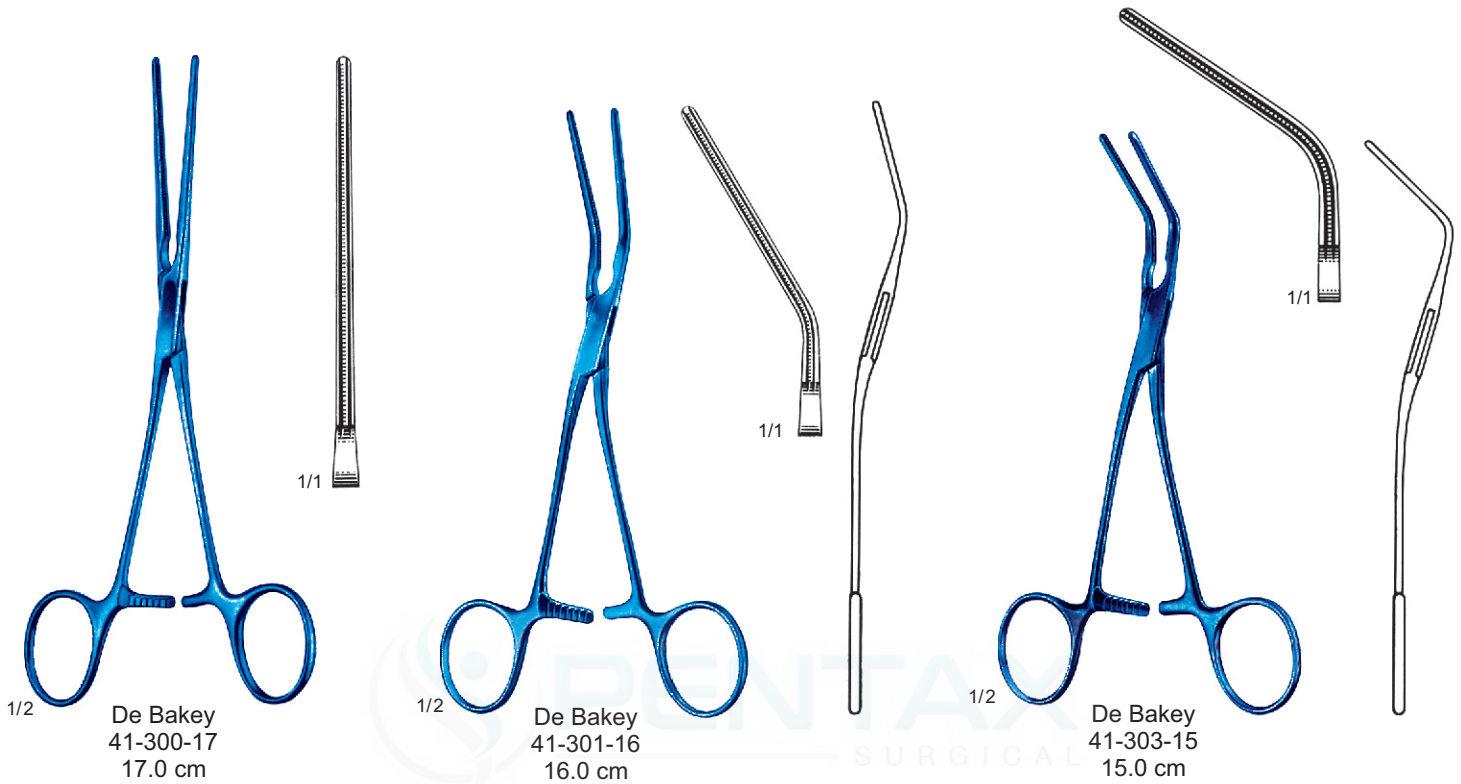

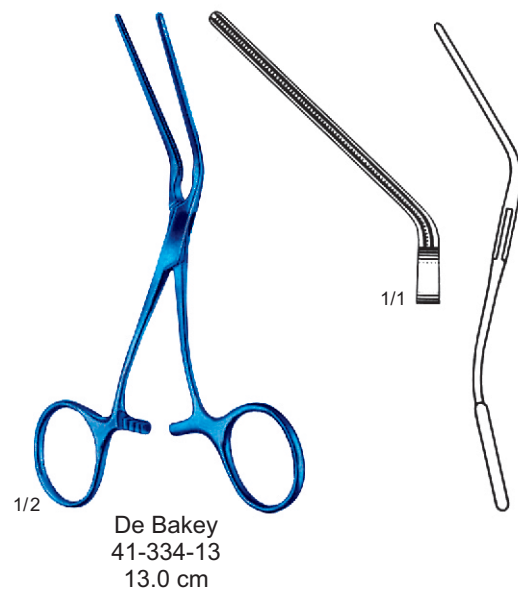
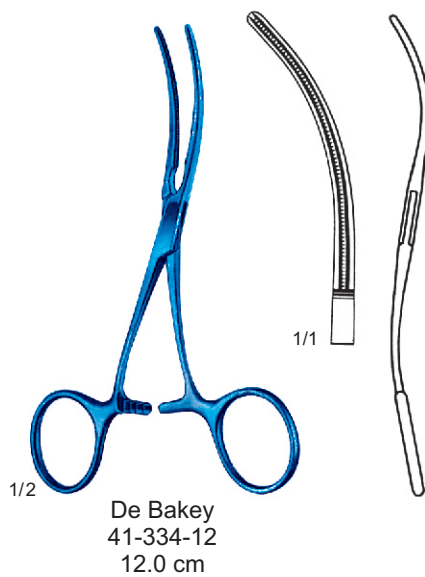
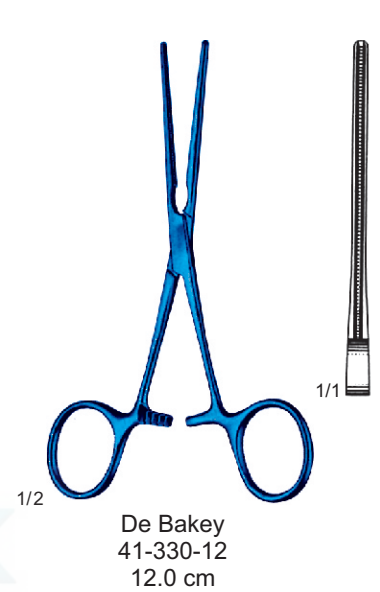
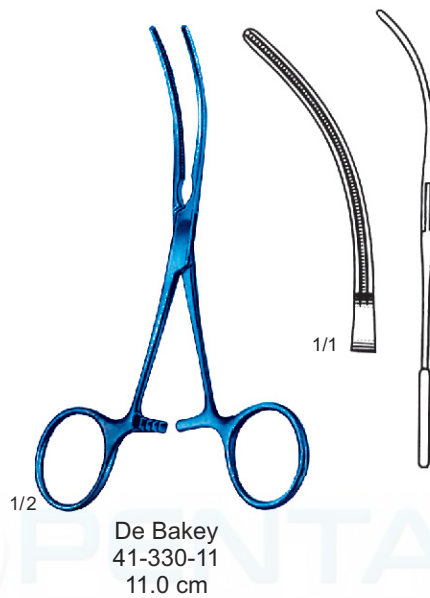

- | | | |
|---|---|---|
| 4.5

1/1
41-400-15
15.0 cm |  | 5.6

41-404-15
15.0 cm |
| | | 1/1
41-404-19
19.0 cm |
| | | 41-404-25
25.0 cm |

Allis
41-400-15 - 41-404-25



41-450-18 - 41-451-18

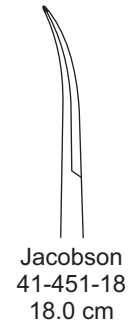
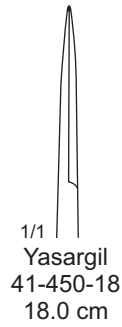



1/1
 Yasargil
 41-480-16 - 41-487-20

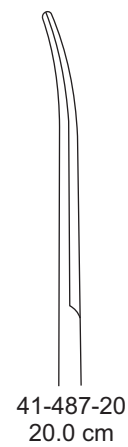
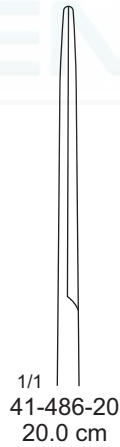
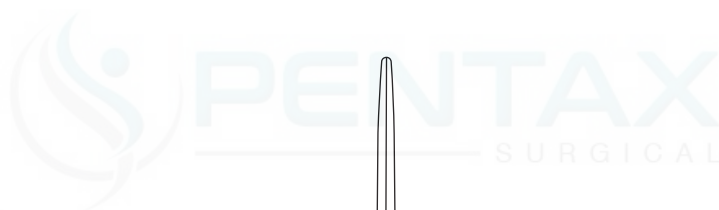
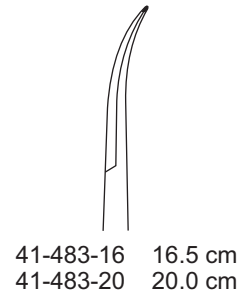
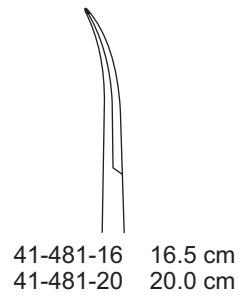
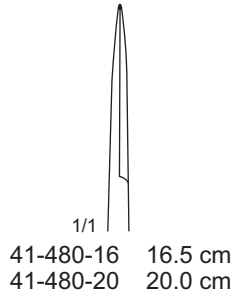

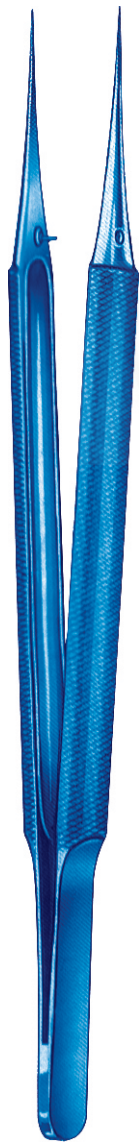

41-500-15 - 41-505-21



1/1
 41-500-15 15.0 cm
 41-500-18 18.0 cm
 41-500-21 21.0 cm
 0.4 mm



41-501-15 15.0 cm
 41-501-18 18.0 cm
 41-501-21 21.0 cm
 0.4 mm



41-504-15 15.0 cm
 41-504-18 18.0 cm
 41-504-21 21.0 cm
 0.8 mm



41-505-15 15.0 cm
 41-505-18 18.0 cm
 41-505-21 21.0 cm
 0.8 mm



1/1
 41-560-12 - 41-565-23



41-560-12 12.0 cm
 41-560-15 15.0 cm
 41-560-18 18.0 cm
 0.3 mm



41-561-12 12.0 cm
 41-561-15 15.0 cm
 41-561-18 18.0 cm
 0.3 mm

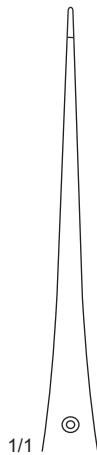



41-564-18 18.0 cm
 41-564-21 21.0 cm
 41-564-23 23.0 cm
 0.6 mm



41-565-18 18.0 cm
 41-565-21 21.0 cm
 41-565-23 23.0 cm
 0.6 mm



1/1			
41-580-16	16.0 cm	41-584-16	16.0 cm
41-580-18	18.0 cm	41-584-18	18.0 cm
41-580-20	20.0 cm	41-584-20	20.0 cm
41-580-22	22.0 cm	41-584-22	22.0 cm
41-580-24	24.0 cm	41-584-24	24.0 cm
	0.6 mm		0.9 mm
			41-588-18 18.0 cm 1:2 Teeth



Yasargil
 41-580-16 - 41-588-18



1/1⊙
 Yasargil
 41-600-03
 22.0 cm
 Ø 3.0 mm

⊙
 Yasargil
 41-600-05
 22.0 cm
 Ø 5.0 mm

⊙
 Yasargil
 41-602-03
 22.0 cm
 Ø 3.0 mm

⊙
 Yasargil
 41-602-05
 22.0 cm
 Ø 5.0 mm

1/1⊙
 Yasargil - Samii
 41-606-03
 24.0 cm
 Ø 3.0 mm

⊙
 Yasargil - Samii
 41-606-05
 24.0 cm
 Ø 5.0 mm

⊙
 Yasargil - Samii
 41-606-07
 24.0 cm
 Ø 7.0 mm

1/1⊙
 Heifetz
 41-610-03
 22.0 cm
 Ø 3.0 mm

⊙
 Heifetz
 41-610-05
 22.0 cm
 Ø 5.0 mm



41-600-03 - 41-610-05

Neurosurgery - Neurochirurgie - Neurocirugía
 Micro - Needle Holders, bayonet - shaped / Titanium
 Mikro - Nadelhalter, bajonettformig / Titan
 Micro - porta - agujas, en forma bayoneta / Titanio



41-640-16	16.5 cm
41-640-20	20.0 cm
41-640-22	22.5 cm
41-640-24	24.5 cm



41-641-16	16.5 cm
41-641-20	20.0 cm
41-641-22	22.5 cm
41-641-24	24.5 cm

Yasargil
 41-640-16 - 41-641-24

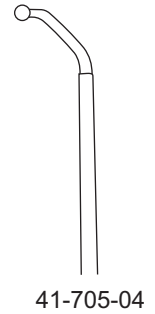
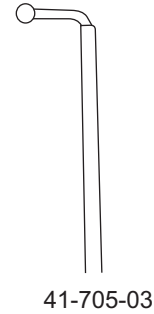
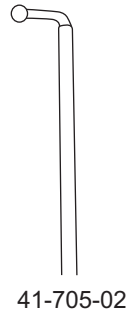
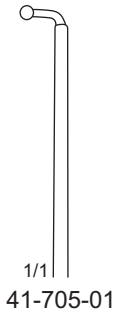

Caspar
41-705-01 - 41-705-04
24.5 cm

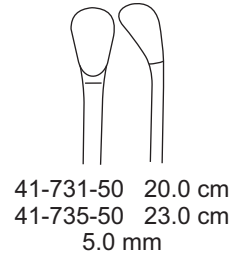
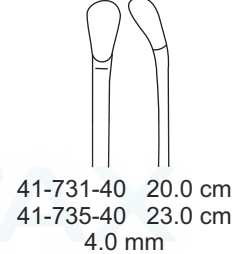
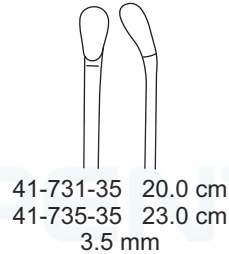
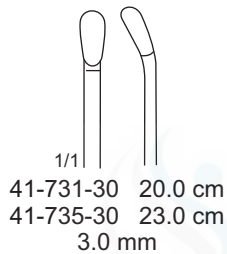
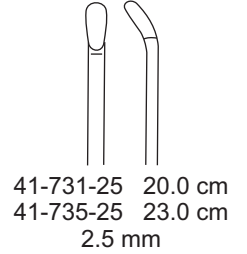
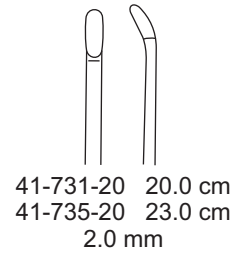
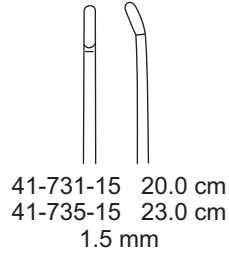
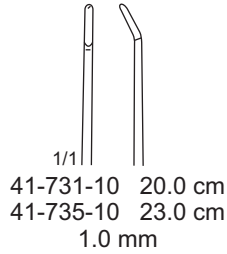

Samii
 41-731-10 - 41-735-50



Samii
 41-751-15 - 41-763-25

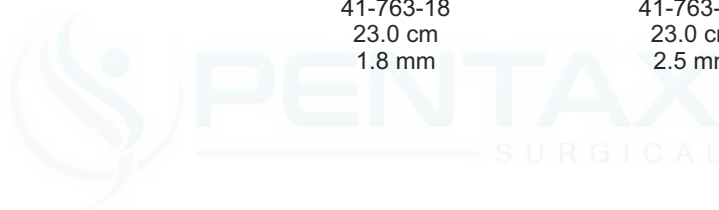
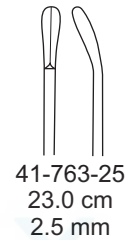
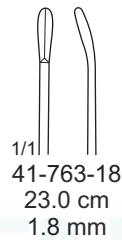
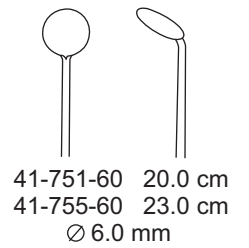
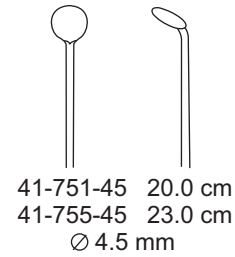
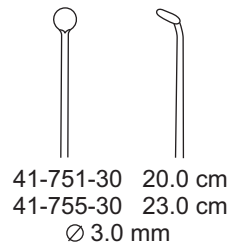
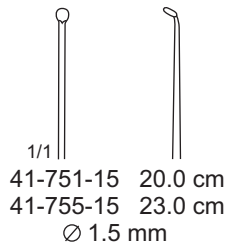



41-781-10 - 41-799-18

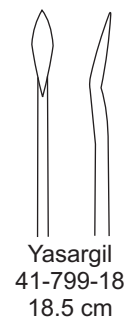
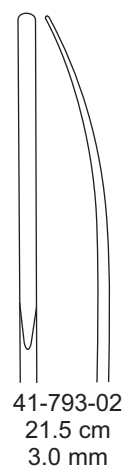
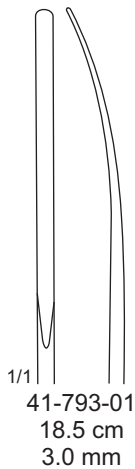
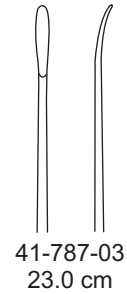
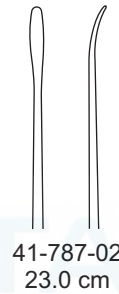
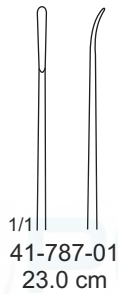
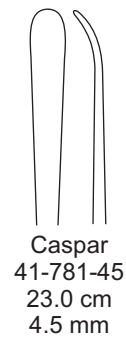
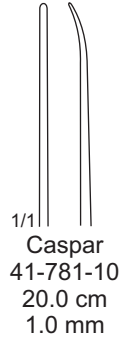



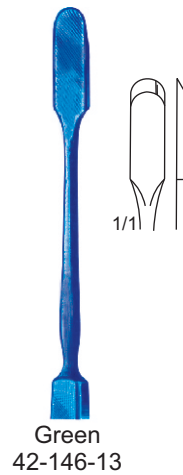
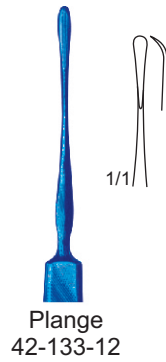
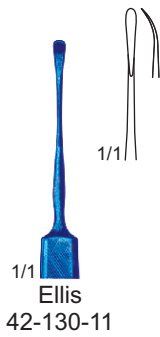



1/2
Graefe
42-170-13 - 42-173-13



1/1
42-170-13



42-171-13



42-173-13

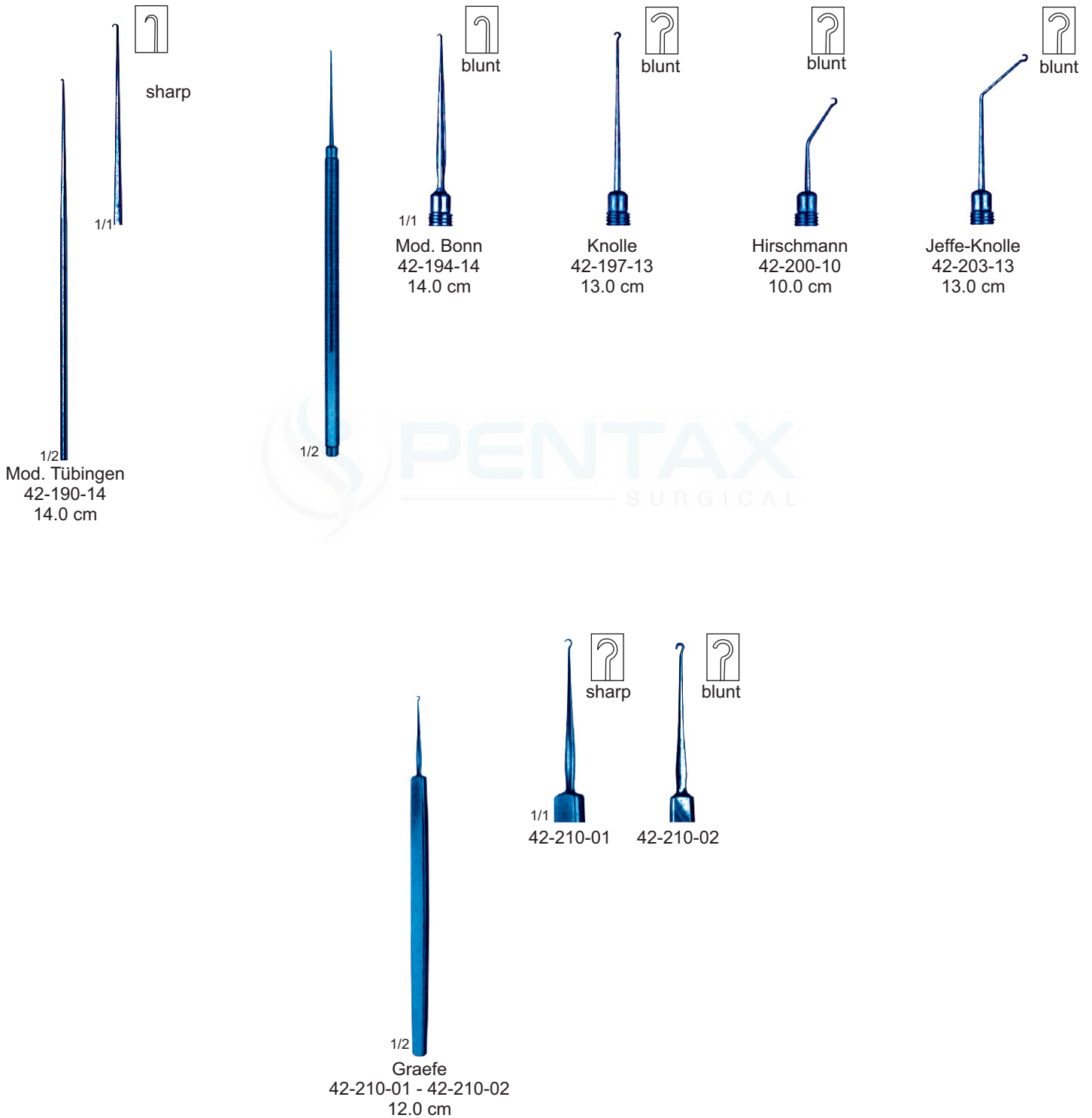

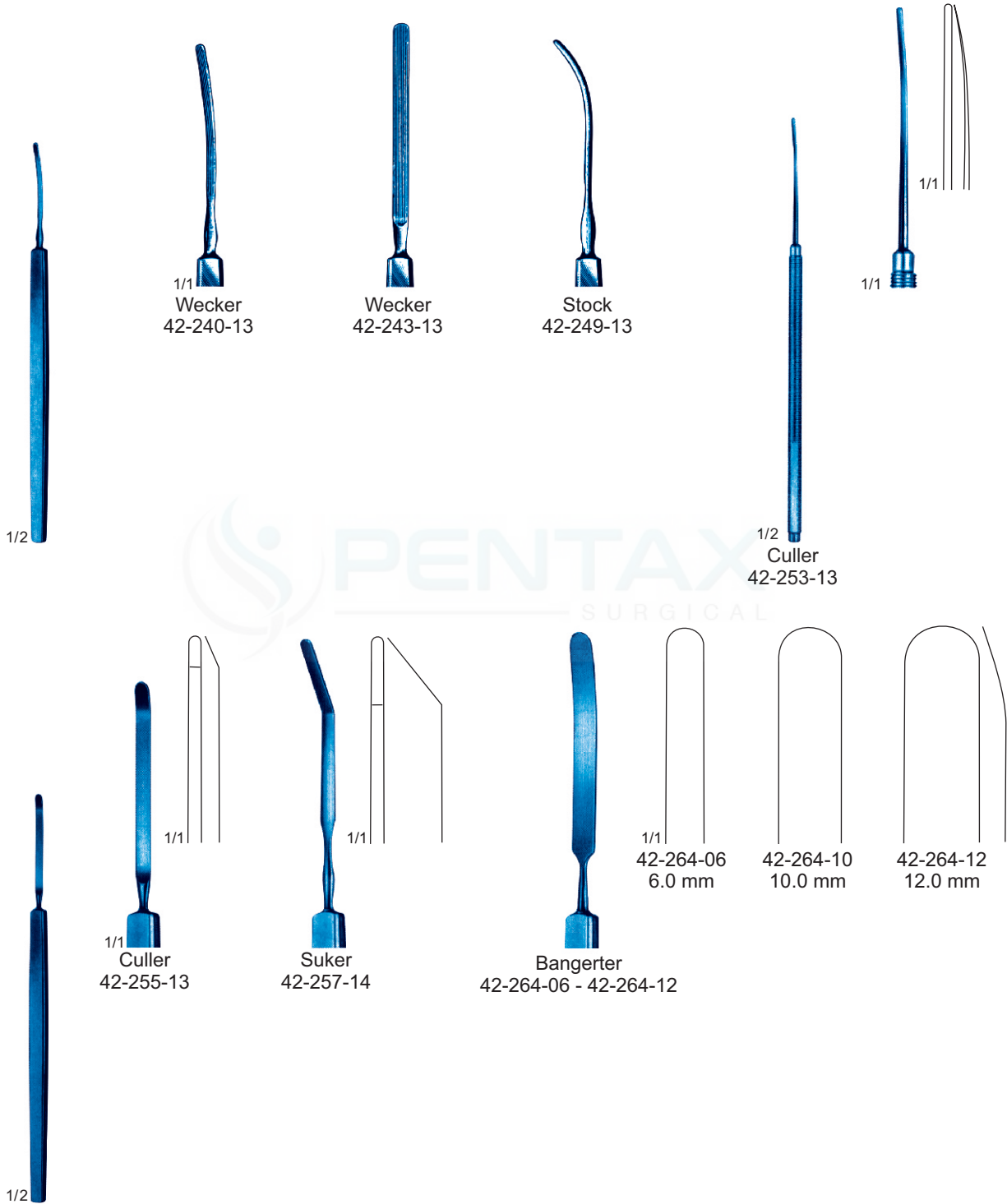

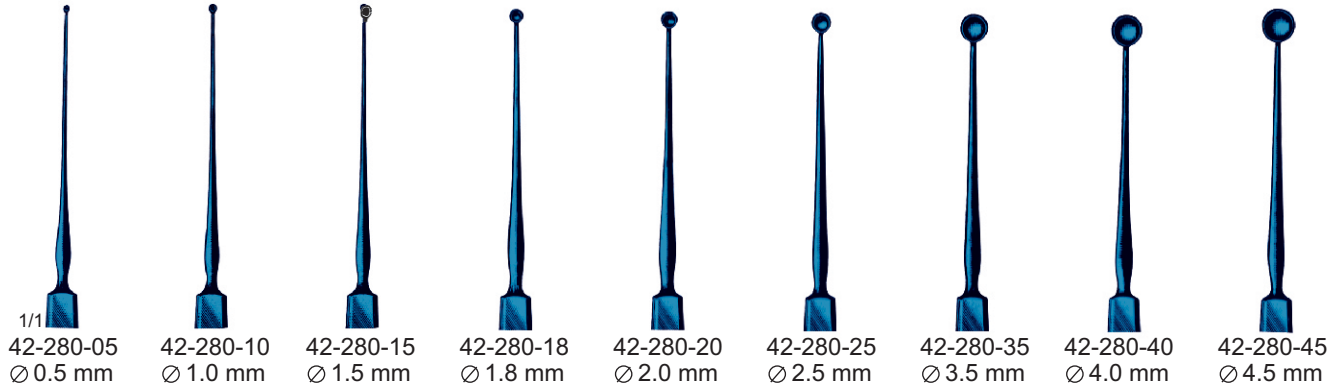

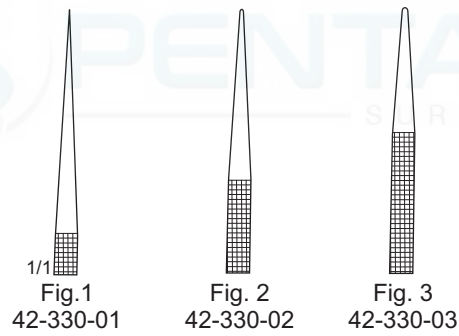

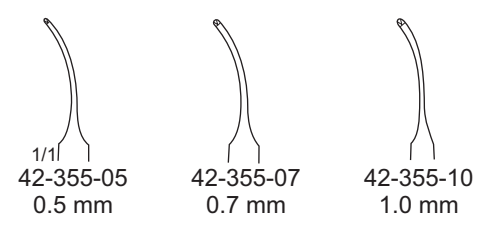
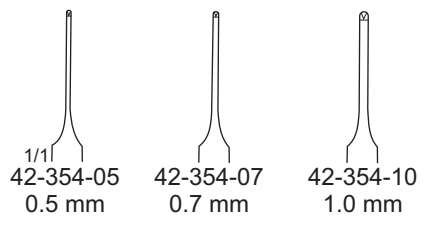
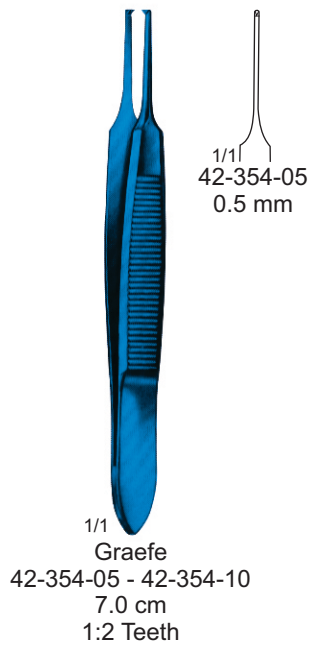
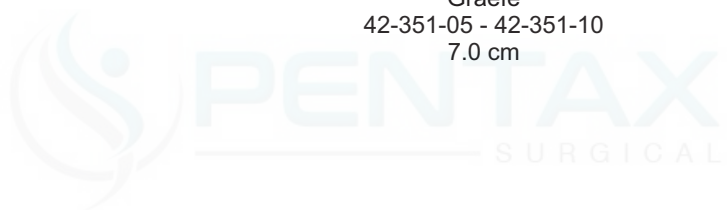
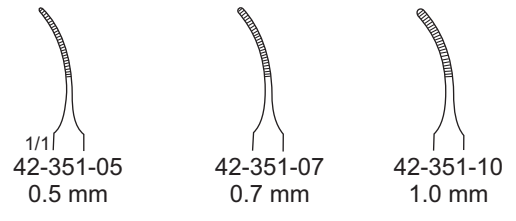
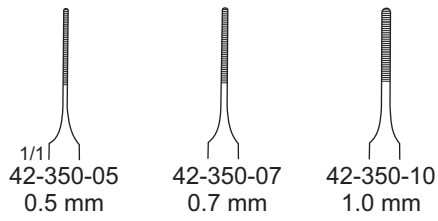





1/1
Tübingen
42-400-10
10.0 cm



1/1
Tübingen
42-401-10
10.0 cm

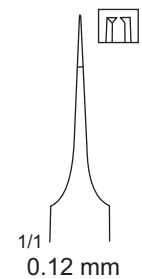

1/1
Tübingen
42-406-10
10.0 cm
1:2 Teeth



1/1
Castroviejo
42-410-01 - 42-410-15
10.0 cm
1:2 Teeth

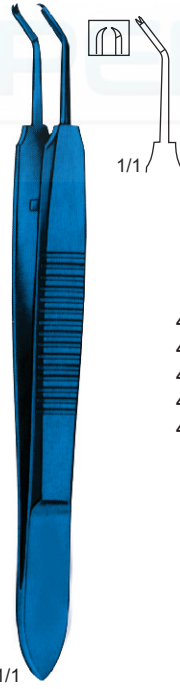

1/1
Castroviejo
42-411-01 - 42-411-15
10.0 cm
1:2 Teeth

width of teeth

42-410-01	0.12 mm	42-411-01
42-410-03	0.30 mm	42-411-03
42-410-05	0.50 mm	42-411-05
42-410-10	1.00 mm	42-411-10
42-410-15	1.50 mm	42-411-15

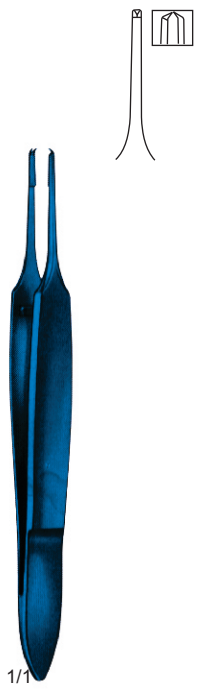

1/1
St. Martin
42-420-07
7.0 cm
1:2 Teeth



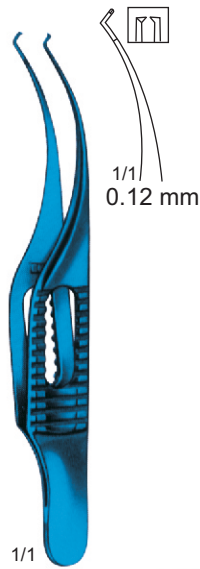

1/1
 Barraquer (Colibri)
 42-460-07
 7.0 cm
 1:2 Teeth

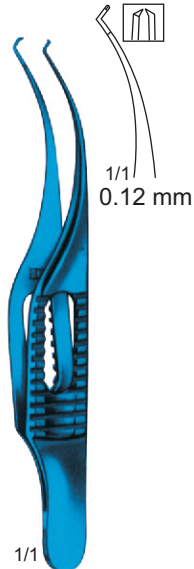

1/1
 Barraquer (Colibri)
 42-461-07
 7.0 cm
 1:2 Teeth

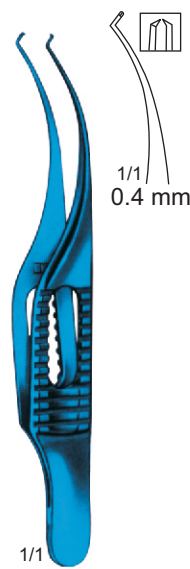

1/1
 Barraquer - Katzin (Colibri)
 42-464-07
 7.0 cm
 1:2 Teeth

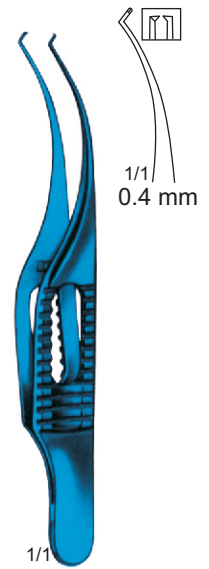

1/1
 Barraquer - Katzin (Colibri)
 42-465-07
 7.0 cm
 1:2 Teeth

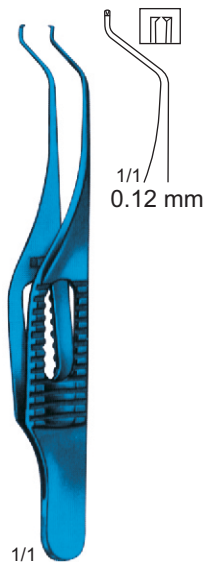

1/1
 Troutman (Colibri)
 42-468-07
 7.5 cm
 1:2 Teeth



1/1
 Kirby - Artur
 42-473-09
 9.0 cm
 1:2 Teeth



1/1
 Kirby - Artur
 42-475-09
 9.0 cm
 1:2 Teeth



1/1
 Castroviejo
 42-490-09
 9.0 cm



1/1
 Castroviejo
 42-491-09
 9.0 cm



1/1
 Castroviejo
 42-494-09
 9.0 cm



1/1
 Castroviejo
 42-495-09
 9.0 cm

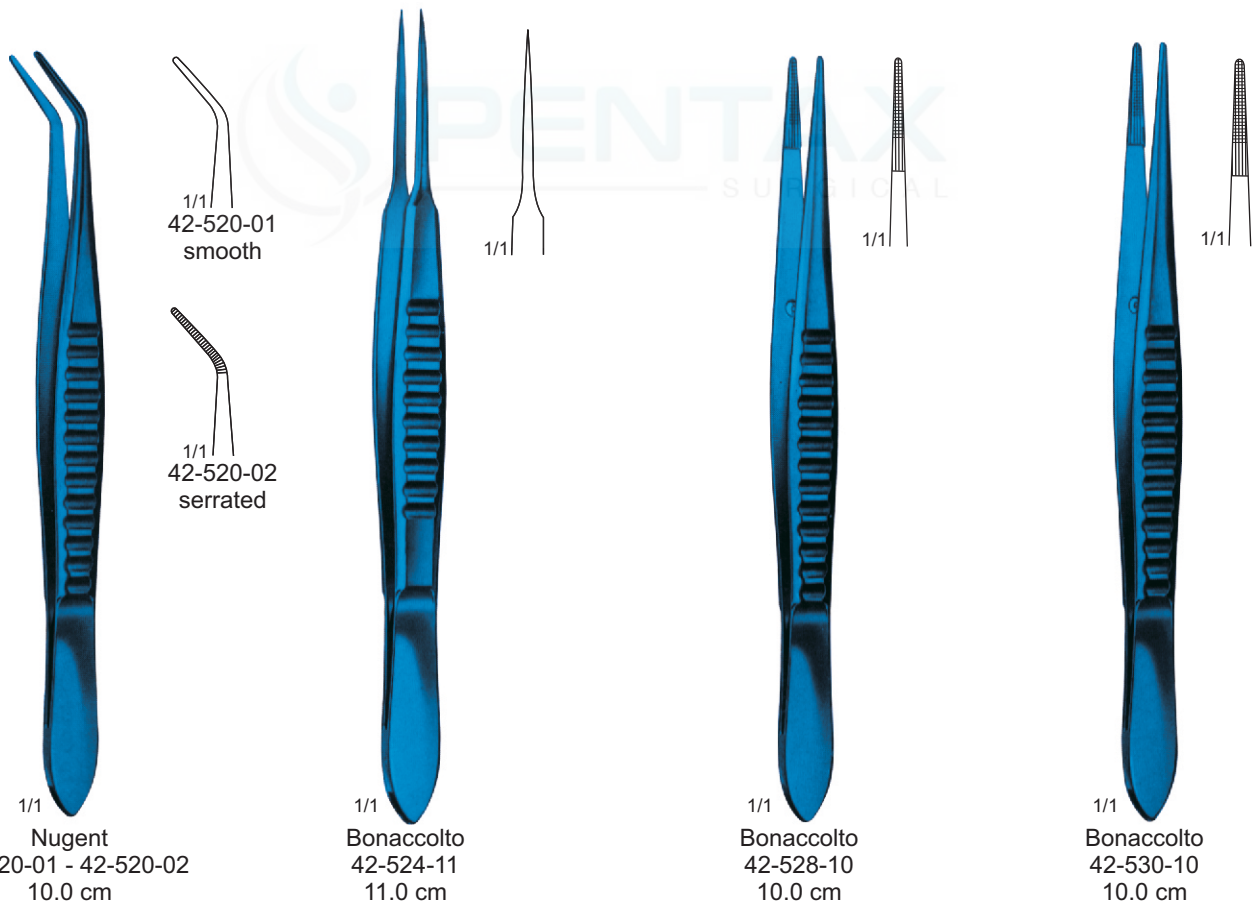



Index (English)

A

Adson Dressing Forcep	40-19
Adson Tissue Forcep	40-20
Allis Tissue & Organ Holding Forcep	41-12
Alvis Foreign Body Instrument	42-2
Artery Forceps	40-27 – 40-30
Atrauma Cardiovascular Forceps	41-10, 41-11
Atrauma Tissue Forceps	40-25, 40-26

B

Bangerter Cyclodialysis Spatula	42-6
Barraquer (Colibri) Fixation Forcep	42-14
Barraquer-Katzin (Colibri) Fixation Forcep	42-14
Bishop-Harman Fixation Forcep	42-13
Bonaccolto Suture Forcep	42-16
Bowman Foreign Body Instrument	42-2

C

Caspar Exploration & Coagulation Hook	41-20
Caspar Micro Dissector	41-23
Castaneda Rib Spreader	41-9
Castroviejo Fixation Forcep	42-15
Castroviejo Iris Scissor	40-16
Castroviejo Micro-Needle Holder	41-3
Castroviejo Razor Blade Holder & Breaker	40-3
Castroviejo Suture Forcep	42-12
Chalazion Curettes	42-7
Cooley Rib Spreader	41-8
Crile Artery Forcep	40-28
Crile-Rankin Artery Forcep	40-28
Crile-Wood Needle Holder	41-4
Culler Cyclodialysis Spatula	42-6
Cyclodialysis Spatulas	42-6
Cystotomes	42-4

D

Davis Foreign Body Instrument	42-2
De Bakey Atrauma Cardiovascular Forcep	41-10, 41-11
De Bakey Atrauma Tissue Forceps	40-25, 40-26
Dermot Pierse (Colibri) Fixation Forcep	42-17
Dermot Pierse Skeleton Forcep	42-17
Dietrich Scissor for Cardiovascular Surgery	40-14
Dissecting Scissors	40-10 – 40-13
Dix Foreign Body Instrument	42-2
Dressing Forceps	40-19

E

Ellis Foreign Body Instrument	42-3
Exploration & Coagulation Hooks	41-20
Eye Scissors	40-15

F

Finocchietto Rib Spreader	41-5, 41-7
Finocchietto-Bady Rib Spreader	41-5
Finocchietto-Bady-Haight Rib Spreader	41-7
Finocchietto-Infant Rib Spreader	41-7
Fixation Forceps	42-13 – 42-15
Fixation Forceps (Colibri)	42-17
Foreign Body Instruments	42-2, 42-3
Francis Foreign Body Instrument	42-2

G

Gomel Micro Forcep	40-24
Graefe Cystotome	42-4
Graefe Iris Forcep	42-9
Graefe Iris Hook	42-5
Grasping Forceps	40-21
Green Foreign Body Instrument	42-3

H

Halsey Needle Holder	41-4
Halsted-Mosquito Artery Forcep	40-27
Hartmann Artery Forcep	40-27
Heifetz Tumor & Tissue Grasping Forcep, bayonet-shaped	41-18
Heifetz Tumor Forcep	40-23
Hirschmann Iris Hook	42-5

I

Iris Eye Scissor	40-15
Iris Forceps	42-9, 42-10
Iris Hooks	42-5
Iris Scissors	40-15, 40-16

J

Jacobson Micro Spring Type Scissor	41-13
Jeffe-Knolle Iris Hook	42-5
Jeweler's Forceps	40-22, 40-23

K

Kelly Artery Forcep	40-28
Kelly-Rankin Artery Forcep	40-28
Kirby-Artur Fixation Forcep	42-14
Knolle Iris Hook	42-5
Kocher (Ochsner) Artery Forcep	40-30

L

La Force Foreign Body Instrument	42-2
Lachrymal Probes	42-8
Levinson Foreign Body Instrument	42-2

M

Mayo Dissecting Scissor	40-10
Mayp-Hegar Needle Holder	41-4
Metzenbaum Dissecting Scissor	40-11
Metzenbaum-Nelson Dissecting Scissor	40-12, 40-13
Meyer Foreign Body Instrument	42-3
Meyhoefer Chalazion Curette	42-7
Micro Dissectors	41-23
Micro Forceps	40-24
Micro Forceps, bayonet-shaped	41-17
Micro Scissors	40-18
Micro Spring Type Scissors	41-13, 41-14
Micro Suture Tying Forceps	41-15, 41-16
Micro-Needle Holders	41-2, 41-3
Micro-Needle Holders, bayonet-shaped	41-19
Mod. Bonn Iris Hook	42-5
Mod. Tübingen Iris Hook	42-5
Morse-Favaloro Rib Spreader	41-6

N

Narrow Dressing Forcep	40-19
Needle Holders	41-4
Nicati Foreign Body Instrument	42-3
Noyes Iris Scissor	40-15
Nugent Suture Forcep	42-16

O

Operating Scissors	40-4 – 40-9
--------------------	-------------

P

Plange Foreign Body Instrument	42-3
Potts-Smith Scissor for Cardiovascular Surgery	40-14

R

Razor Blade Holders & Breakers	40-3
Reill Micro-Needle Holder	41-2
Rib Spreaders	41-5 – 41-9
Rochester Pean Artery Forcep	40-29
Rpillet Foreign Body Instrument	42-3
Russ. Modell Grasping Forcep	40-21

Index (English)

S

Samii Tumor Knife	41-21, 41-22
Scalpel Handles	40-2
Schweiz Mod. Foreign Body Instrument	42-2
Scissors for Cardiovascular Surgery	40-14
Secondary Cataract Scissors	40-17
Skeleton Forceps	42-17
St. Martin Suture Forcep	42-12
Standard Dressing Forcep	40-19
Standard Operating Scissor	40-4 – 40-9
Standard Scalpel Handles	40-2
Stevens Iris Forcep	42-10
Stock Cyclodialysis Spatula	42-6
Suker Cyclodialysis Spatula	42-6
Suture Forceps	42-11, 42-12, 42-16

T

Tenotomy Scissors	40-18
Tissue & Organ Holding Forceps	41-12
Tissue Forceps	40-20
Troutman (Colibri) Fixation Forcep	42-14
Troutman-Chris Razor Blade Holder & Breaker	40-3
Tübingen Suture Forcep	42-11
Tumor & Tissue Grasping Forceps, bayonet-shaped	41-18
Tumor Forceps	40-23
Tumor Knives	41-21, 41-22

V

Vannas Mod. Tübingen Secondary Cataract Scissor	40-17
Vannas Secondary Cataract Scissor	40-17

W

Walton Foreign Body Instrument	42-3
Webster Needle Holder	41-4
Wecker Cyclodialysis Spatula	42-6
Westcott Tenotomy Scissor	40-18
Wilder Lachrymal Probe	42-8

Y

Yasargil Micro Dissector	41-23
Yasargil Micro Forceps, bayonet-shaped	41-17
Yasargil Micro Spring Type Scissor	41-13, 41-14
Yasargil Micro-Needle Holders, bayonet-shaped	41-19
Yasargil Tumor & Tissue Grasping Forcep, bayonet-shaped	41-18

Yasargil Tumor Forcep	40-23
Yasargil-Samii Tumor & Tissue Grasping Forcep, bayonet-shaped	41-18

Inhaltsverzeichnis (Deutsch)

A

Adson Anatomische Pinzetten	40-19
Adson Chirurgische Pinzetten	40-20
Allis Gewebe- und Organ-Faßzangen	41-12
Alvis Fremdkörper – Instrumente	42-2
Anatomische Pinzetten	40-19
Arterienklemmen	40-27 – 40-30
Atrauma Cardiovascular-Klemmen	41-10, 41-11
Atrauma Pinzetten	40-25, 40-26
Augenscheren	40-15

B

Bangerter Zyklodialyse – Spatel	42-6
Barraquer (Colibri) Fixierpinzetten	42-14
Barraquer-Katzin (Colibri) Fixierpinzetten	42-14
Bishop-Harman Fixierpinzetten	42-13
Bonaccolto Nahtpinzetten	42-16
Bowman Fremdkörper – Instrumente	42-2

C

Caspar Explorations- und Koagulations haken	41-20
Caspar Mikro – Dissektoren	41-23
Castaneda Rippensperrerr	41-9
Castroviejo Fixierpinzetten	42-15
Castroviejo	40-16
Iridektomiescheren	
Castroviejo Mikro – Nadelhalter	41-3
Castroviejo Nahtpinzetten	42-12
Castroviejo	40-3
Rasierklingshalter und –brecher	
Chalazionlöffel	42-7
Chirurgische Pinzetten	40-20
Chirurgische Scheren	40-4 – 40-9
Cooley Rib Rippensperrerr	41-8
Crile Arterienklemmen	40-28
Crile-Rankin	40-28
Arterienklemmen	
Crile-Wood Nadelhalter	41-4
Culler Zyklodialyse – Spatel	42-6
Cystotome	42-4

D

Davis Fremdkörper – Instrumente	42-2
De Bakey Atrauma Cardiovascular-Klemmen	41-10, 41-11
De Bakey Atrauma Pinzetten	40-25, 40-26
Dermot Pierse (Colibri) Fixierpinzetten	42-17
Dermot Pierse Skeleton – Pinzetten	42-17
Dietrich Scheren für Herz- und Gefäßchirurgie	40-14
Dix Fremdkörper - Instrumente	42-2

E

Ellis Fremdkörper – Instrumente	42-3
Explorations- und Koagulations haken	41-20

F

Faßpinzetten	40-21
Finocchietto Rippensperrerr	41-5, 41-7
Finocchietto-Baby Rippensperrerr	41-5
Finocchietto-Baby-Haight Rippensperrerr	41-7
Finocchietto-Infant Rippensperrerr	41-7
Fixierpinzetten	42-13 – 42-15
Fixierpinzetten (Colibri)	42-17
Francis Fremdkörper – Instrumente	42-2
Fremdkörper – Instrumente	42-2, 42-3

G

Gewebe- und Organ-Faßzangen	41-12
Gomel Mikro – Pinzetten	40-24
Graefe Cystotome	42-4
Graefe Irishäkchen	42-5
Graefe Irispinzetten	42-9
Green Fremdkörper – Instrumente	42-3

H

Halsey Nadelhalter	41-4
Halsted-Mosquito	40-27
Arterienklemmen	
Hartmann Arterienklemmen	40-27
Heifetz Tumor- und Gewebefaßpinzetten, bajonettförmig	41-18
Heifetz Tumorpinzetten	40-23
Hirschmann Irishäkchen	42-5

I

Iridektomiescheren	40-15, 40-16
Iris Augenscheren	40-15
Irishäkchen	42-5
Irispinzetten	42-9, 42-10

J

Jacobson Mikro – Federschere	41-13
Jeffe-Knolle Irishäkchen	42-5

K

Kelly Arterienklemmen	40-28
Kelly-Rankin	40-28
Arterienklemmen	
Kirby-Artur Fixierpinzetten	42-14
Knolle Irishäkchen	42-5
Kocher (Ochsner) Arterienklemmen	40-30

L

La Force Fremdkörper – Instrumente	42-2
Levinson Fremdkörper – Instrumente	42-2

M

Mayo Präparierscheren	40-10
Mayo-Hegar Nadelhalter	41-4
Metzenbaum	40-11
Präparierscheren	
Metzenbaum-Nelson	40-12, 40-13
Präparierscheren	13
Meyer Fremdkörper – Instrumente	42-3
Meyhoefer Chalazionlöffel	42-7
Mikro – Dissektoren	41-23
Mikro – Federschere	41-13, 41-14
Mikro – Knüpfpinzetten	41-15, 41-16
Mikro – Nadelhalter	41-2, 41-3
Mikro – Nadelhalter, bajonettförmig	41-19
Mikro – Pinzetten	40-24
Mikro – Pinzetten, bajonettförmig	41-17
Mikro – Scheren	40-18
Mod. Bonn Irishäkchen	42-5
Mod. Tübingen Irishäkchen	42-5
Morse-Favaloro Rippensperrerr	41-6

N

Nachatarscheren	40-17
Nadelhalter	41-4
Nahtpinzetten	42-11, 42-12, 42-16
Narrow Anatomische Pinzetten	40-19
Nicati Fremdkörper – Instrumente	42-3
Noyes Iridektomiescheren	40-15
Nugent Nahtpinzetten	42-16

P

Plange Fremdkörper – Instrumente	42-3
Potts-Smith Scheren für Herz- und Gefäßchirurgie	40-14
Präparierscheren	40-10 – 40-13

R

Rasierklingenhalter und –brecher	40-3
Reill Mikro – Nadelhalter	41-2
Rippensperrer	41-5 – 41- 9
Rochester Pean	40-29
Arterienklemmen	
Rollet Fremdkörper – Instrumente	42-3
Russ. Modell Faßpinzetten	40-21

S

Samii Tumormesser	41-21, 41- 22
Scheren für Herz- und Gefäßchirurgie	40-14
Schweiz Mod. Fremdkörper – Instrumente	42-2
Sehnenscheren	40-18
Skalpell – Griffe	40-2
Skeleton – Pinzetten	42-17
St. Martin Nahtpinzetten	42-12
Standard Anatomische Pinzetten	40-19
Standard Chirurgische Scheren	40-4 – 40- 9
Standard Skalpell –Griffe	40-2
Stevens Irispinzetten	42-10
Stock Zyklodialyse – Spatel	42-6
Stiker Zyklodialyse – Spatel	42-6

T

Tränenkanalsonden	42-8
Troutman (Colibri)	42-14
Fixierpinzetten	
Troutman-Chris	40-3
Rasierklingenhalter und –brecher	
Tübingen Nahtpinzetten	42-11
Tumor- und Gewebefaßpinzetten, bajonettförmig	41-18
Tumormesser	41-21, 41- 22
Tumorpinzetten	40-23

U

Uhrmacherpinzetten	40-22, 40- 23
--------------------	------------------

V

Vannas Mod. Tübingen Nachstarscheren	40-17
Vannas Nachstarscheren	40-17

W

Walton Fremdkörper – Instrumente	42-3
Webster Nadelhalter	41-4
Wecker Zyklodialyse – Spatel	42-6
Westcott Sehnenscheren	40-18
Wildler Tränenkanalsonden	42-8

Y

Yasargil Mikro – Dissektoren	41-23
Yasargil Mikro –	41-13, 41- 14
Federscheren	14
Yasargil Mikro – Nadelhalter, bajonettförmig	41-19
Yasargil Mikro – Pinzetten, bajonettförmig	41-17
Yasargil Tumor- und Gewebefaßpinzetten, bajonettförmig	41-18
Yasargil Tumorpinzetten	40-23
Yasargil-Samii Tumor- und Gewebefaßpinzetten, bajonettförmig	41-18

Z

Zyklodialyse – Spatel	42-6
-----------------------	------

Indice (Español)

P

Pinzas de agarre para tejido y tumor, en forma bayoneta	41-18
Pinzas de disección	40-19
Pinzas de disección Atrauma	40-25, 40-26
Pinzas de disección con dientes	40-20
Pinzas de esqueleto	42-17
Pinzas de fijación	42-13 – 42-15
Pinzas de fijación (Colibri)	42-17
Pinzas de relojero	40-22, 40-23
Pinzas hemostáticas	40-27 – 40-30
Pinzas para coger	40-21
Pinzas para iris	42-9, 42-10
Pinzas para sujetar y romper hojas de afeitar	40-3
Pinzas para sutura	42-11, 42-12, 42-16
Pinzas para tejidos y órganos	41-12
Pinzas para tumores	40-23
Plange Instrumentos para cuerpos extraños	42-3
Porta – agujas	41-4
Potts-Smith Tijeras para la cirugía Cardiovascular	40-14
Q	
Quistátomos	42-4
R	
Reill Micro - porta agujas	41-2
Rochester Pean Pinzas hemostáticas	40-29
Rollet Instrumentos para cuerpos extraños	42-3
Russ. Modell Pinzas para coger	40-21
S	
Samii Cuchillos para tumorales	41-21, 41-22
Schweiz Mod. Instrumentos para cuerpos extraños	42-2
Separadores costales	41-5 41-9
St. Martin Pinzas para sutura	42-12
Standard Mangos de bisturíes	40-2
Standard Pinzas de disección	40-19
Standard Tijeras para cirugía	40-4 40-9
Stevens Pinzas para iris	42-10
Stock Espátulas para ciclodialisis	42-6
Suker Espátulas para ciclodialisis	42-6

T

Tijeras oculares	40-15
Tijeras para catarata secundaria	40-17
Tijeras para cirugía	40-4 40-9
Tijeras para iridectomia	40-15, 40-16
Tijeras para la cirugía Cardiovascular	40-14
Tijeras para oreparaciones	40-10 40-13
Tijeras para tenotomia	40-18
Troutman (Colibri) Pinzas de fijación	42-14
Troutman-Chris Pinzas para sujetar y romper hojas de afeitan	40-3
Tübingen Pinzas para sutura	42-11

V

Vannas Mod. Tübingen	40-17
Tijeras para catarata secundarias	
Vannas Tijeras para catarata secundaria	40-17

W

Walton Instrumentos para cuerpos extraños	42-3
Webster Porta – agujas	41-4
Wecker Espátulas para ciclodialisis	42-6
Westcott Tijeras para tenotomia	40-18
Wilder Estiletes lacrimales	42-8

Y

Yasargil Micro – pinzas, en forma bayoneta	41-17
Yasargil Micro – porta - agujas, en forma bayoneta	41-19
Yasargil Micro – tijeras con mangos de resortes	41-13, 41-14
Yasargil Micro disecadores	41-23
Yasargil Pinzas de agarre para tejido y tumor, en forma bayoneta	41-18
Yasargil Pinzas para tumores	40-23
Yasargil-Samii Pinzas de agarre para tejido y tumor, en forma bayoneta	41-18