

Manufacturer Of all kind of Plastic Surgery Instruments



PRODUCT CATALOG

PLASTIC SURGERY INSTRUMENTS



COMPANY PROFILE

ABOUT US

WELCOME TO PENTAX SURGICAL

Established in 2008, PENTAX SURGICAL is on a mission to redefine the industry by proving that quality doesn't have to be sacrificed for competitiveness. Our commitment revolves around producing high-quality instruments at prices that keep you smiling. From our humble beginnings as a family-run veriere, we've evolved into a significant player in the market.

Our mission is clear to instill confidence in our clients by delivering Instruments of the highest quality at prices that make sense. We understand that the key to succes lies in customer satisfaction and loyalty, which forms the core of our vision. As we grow, our focus reamins on fostering strong relatorishps with our customers

At PENTAX SURGICAL, we firmly believe that quality is never accidental, it's the outcome of thoughtful and intelligent effort Each instrument we produce reflects this commitment to excellence, ensuring you receive products that exceed expectations. Join us on our journey as we continue to set new standards in quality and customer satisfaction.

Contents

Fiber Optic Retractors	50-2
Retractors	50-11
Breast Dissectors	51-2
Breast Markers	51-4
Markers	51-6
Calipers	51-8
Speculas & Septum Forceps	51-9
Breast Spreaders	51-10
Endo Dissectors	51-11
Fiber Optic Light Guide	51-21



50

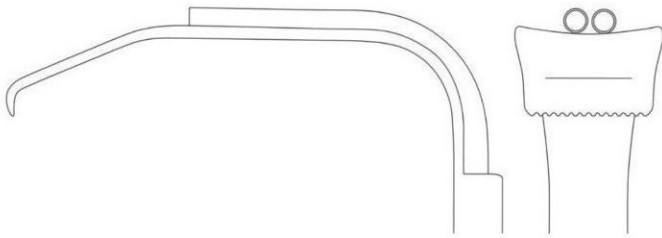

Tebbets

Ferriera

Tebbets			Ferriera		
with light guide	with light guide & suction	blades	with light guide	with light guide & suction	blades
50-100-01	50-110-01	16 x 80 mm	50-130-01	50-140-01	14 x 70 mm
50-100-02	50-110-02	24 x 90 mm	50-130-02	50-140-02	14 x 90 mm
50-100-03	50-110-03	24 x 100 mm	50-130-03	50-140-03	16 x 80 mm
50-100-04	50-110-04	25 x 100 mm	50-130-04	50-140-04	16 x 150 mm
50-100-05	50-110-05	25 x 120 mm	50-130-05	50-140-05	23 x 100 mm
50-100-06	50-110-06	23 x 150 mm	50-130-06	50-140-06	23 x 150 mm
50-100-07	50-110-07	30 x 90 mm	50-130-07	50-140-07	23 x 180 mm
50-100-08	50-110-08	30 x 120 mm	50-130-08	50-140-08	25 x 100 mm
50-100-09	50-110-09	30 x 150 mm	50-130-09	50-140-09	25 x 120 mm
50-100-10	50-110-10	36 x 160 mm	50-130-10	50-140-10	25 x 150 mm
50-100-11	50-110-11	36 x 190 mm	50-130-11	50-140-11	25 x 190 mm
			50-130-12	50-140-12	30 x 120 mm
			50-130-13	50-140-13	30 x 150 mm



Biggs

retractor only	with light guide	with light guide & suction	blades width		
50-150-01	50-160-01	50-170-01	30 mm	50-190-01	25 x 180 mm
50-150-02	50-160-02	50-170-02	50 mm		



Multi Approach
 50-200-23
 23 x 180 mm



Face-Life

retractor only	with light guide	blades
50-210-22	50-220-22	22 x 110 mm



Wieder

Freeman

Wieder			Freeman			
retractor only	with light guide	with light guide & suction	blades	retractor only	with light guide	blades
24-337-01	50-290-01	50-300-01	38 x 140 mm	50-320-01	50-330-01	13 x 180 mm
24-337-02	50-290-02	50-300-02	45 x 150 mm	50-320-02	50-330-02	12 x 200 mm
				50-320-03	50-330-03	25 x 200 mm



Deaver



Harrington
32 cm

Deaver			Harrington			
retractor only	with light guide	blades	retractor only	with light guide	with light guide & suction	blades
09-511-01	50-380-01	19 x 180 mm	09-476-40	50-410-01	50-420-01	40 x 127 mm
	50-380-02	13 x 200 mm	09-476-62	50-410-02	50-420-02	62 x 127 mm
09-511-02	50-380-03	22 x 200 mm				
	50-380-04	25 x 200 mm				
09-511-03	50-382-01	25 x 230 mm				
09-511-04	50-382-02	25 x 300 mm				
09-511-05	50-382-03	25 x 330 mm				
09-511-06	50-382-04	25 x 350 mm				
09-511-07	50-384-01	38 x 300 mm				
09-511-08	50-384-02	50 x 300 mm				
09-511-09	50-384-03	75 x 300 mm				



Sigmoid Notch
 50-440-01
 22 cm

retractor only



Sigmoid Notch
 50-440-02
 22 cm

with light guide



Petri Pterygoid
 50-450-01
 23 cm

retractor only



Petri Pterygoid
 50-450-02
 23 cm

with light guide

16 mm



Bauer
50-480-01
21 cm

retractor only

16 mm



Bauer
50-480-02
21 cm

retractor only

16 mm



Bauer
50-490-01
21 cm

with light guide

16 mm



Bauer
50-490-02
21 cm

with light guide

27 mm



Levasseur Merrill
50-520-01
25 cm
retractor only

27 mm



Levasseur Merrill
50-530-01
25 cm
with light guide

14.5 mm



Shea
50-550-01
25 cm
with light guide



Breast Spatula
31.5 cm

Breast Retractor
31.5 cm

working tip

blades

50-600-01	25 x 155 mm	50-610-01
50-600-02	38 x 155 mm	50-610-02

50-630-01	22 x 55 mm
50-630-02	38 x 70 mm

2 recessed prongs

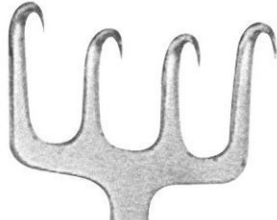

50-700-04
38 mm

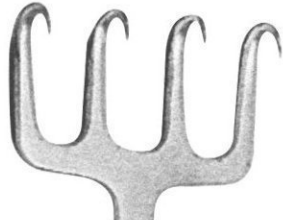

50-700-03
38 mm

38 mm



Freeman
50-710-18
18 cm

2 recessed prongs



50-700-02
22 mm

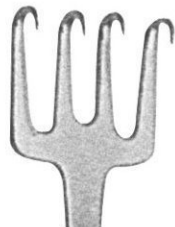

50-700-01
22 mm



Freeman
50-700-01 - 50-700-04
18 cm



Freeman
10 cm

blades

50-720-22 22 mm
50-720-38 38 mm

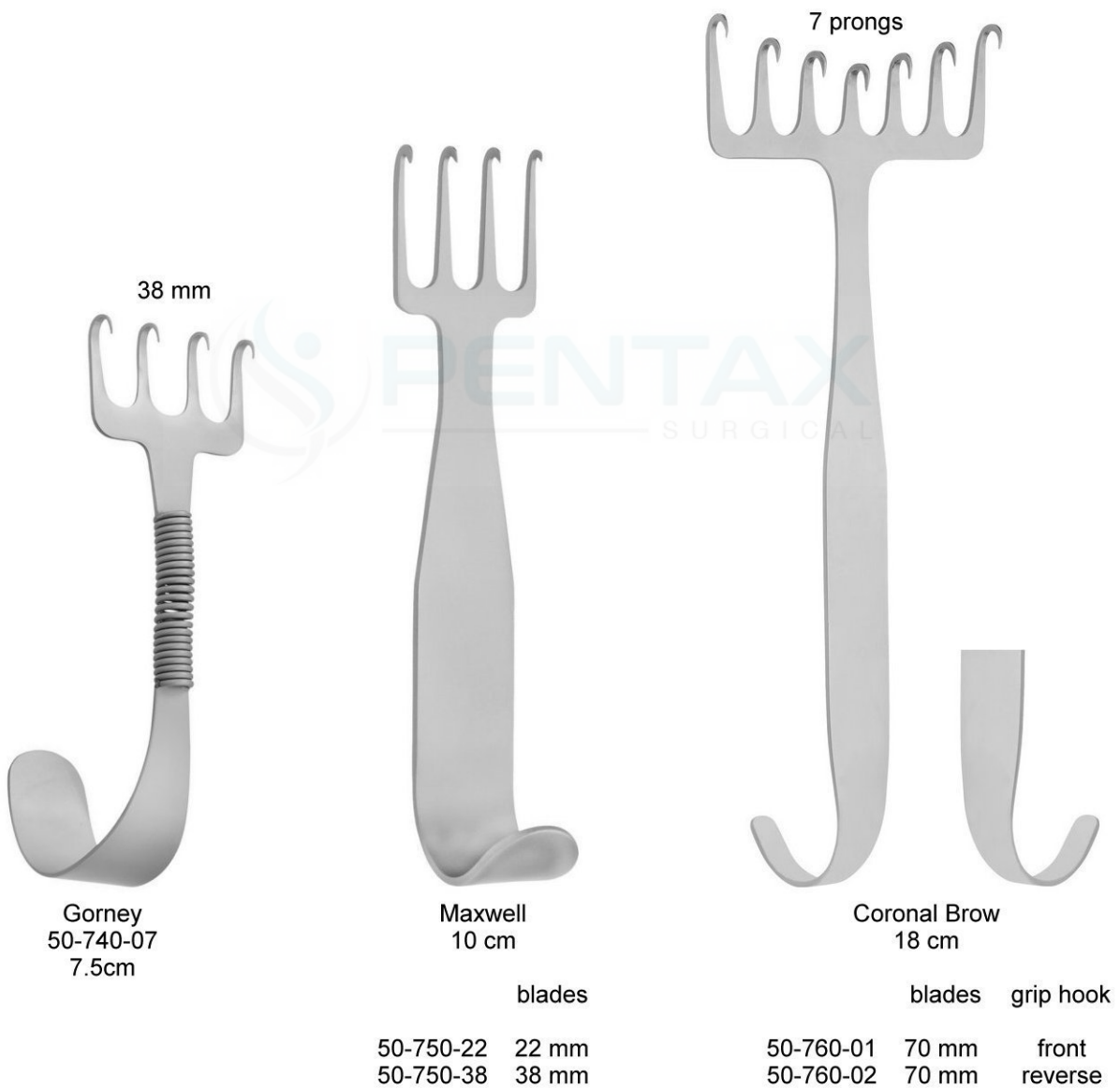

6 prongs



Coronal Lift
21 cm

blade width

50-790-21 150 mm

6 prongs



Yancoskie
19 cm

blade width

50-800-19 150 mm

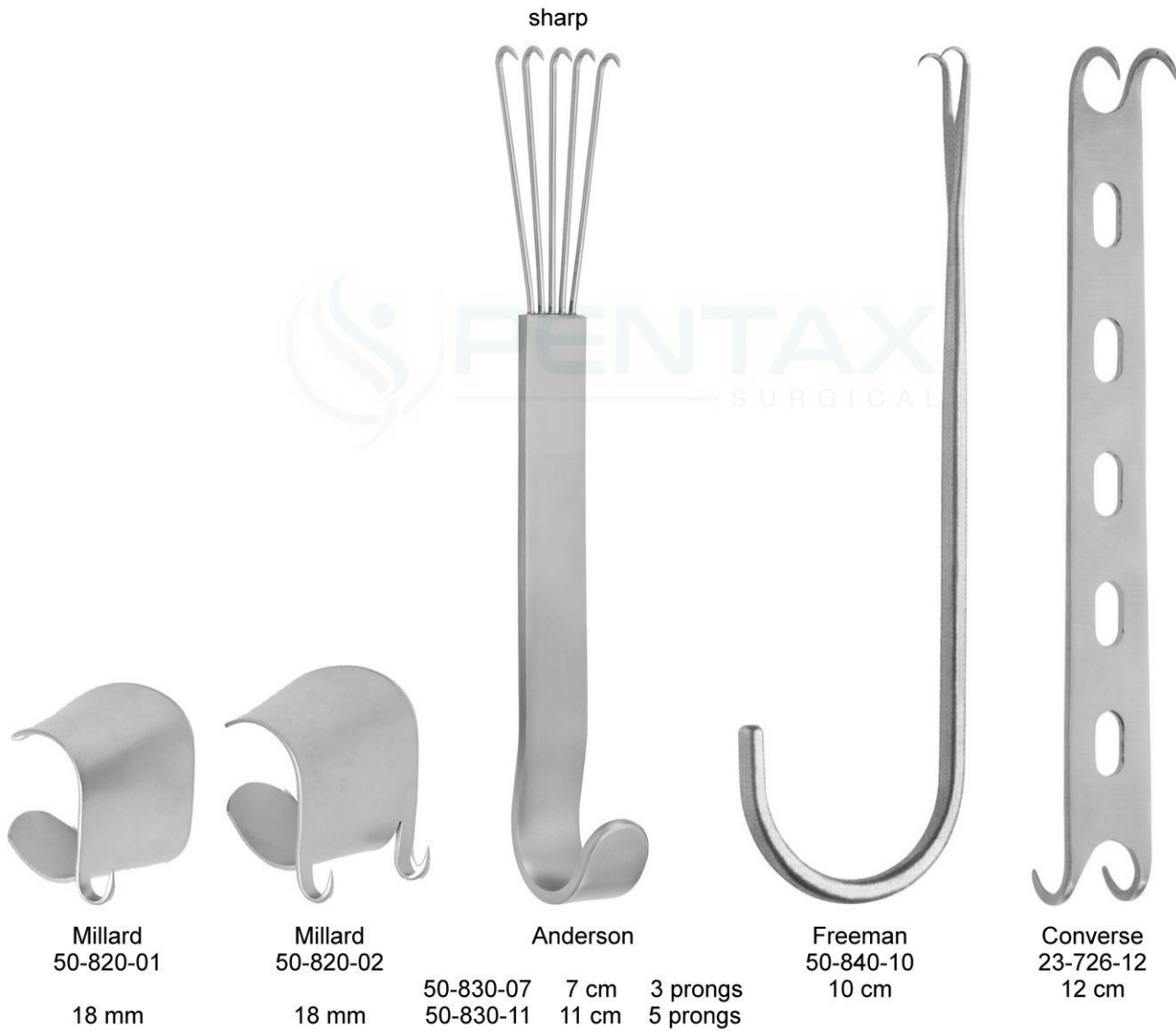



Martinez - Kilner
50-850-11
11.5 cm
7.5 mm



Martinez - Kilner
50-852-08
8 cm
10 mm



Clodius
20-860-01
13 mm / 20 mm



Wise
20-870-16
16.5 cm



Sheen
20-880-16
16 cm



Sheen
20-890-15
15 cm

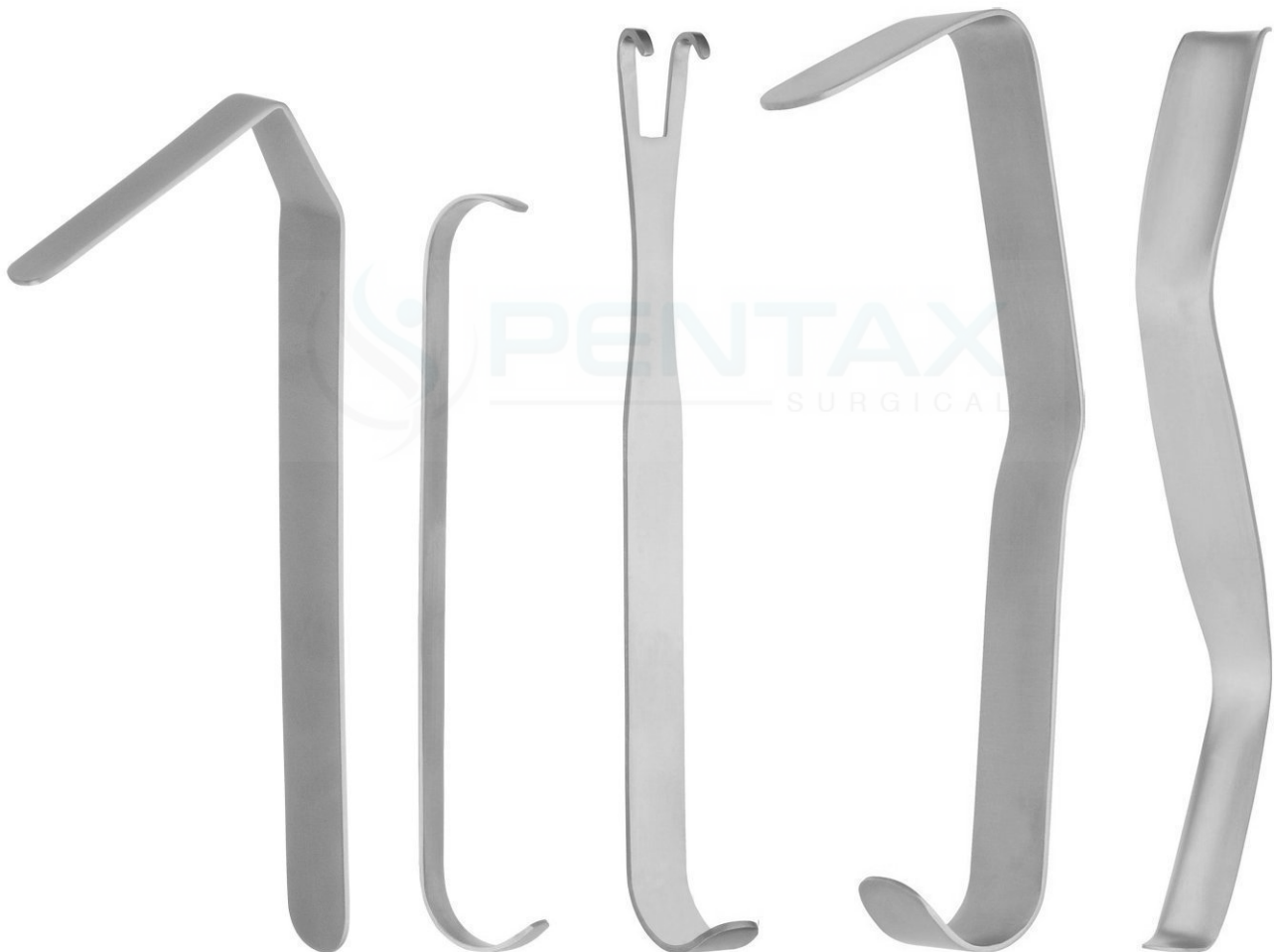

Bernstein
50-910-08
8 x 46 mm

Carolin
50-920-11
11 cm

Cronin
50-930-15
15.5 cm

Cronin
50-940-16
16.5 cm

Fischl
50-950-16
16 cm



51



Spatulated
 51-100-33
 33 cm

Agris - Dingman
 51-110-01 right
 51-110-02 left
 36 cm

51-110-12 pair

McCollum - Dingman
 51-130-30
 30 cm

McCollum - Dingman
 51-136-41
 41 cm

Reynolds
 51-150-33 33 cm
 51-150-40 40 cm



51-170-33 33 cm
 51-170-42 42 cm
 rigid

51-190-33 33 cm
 51-190-42 42 cm
 rigid

51-200-33 33 cm
 51-200-42 42 cm
 rigid

Jacobs
 51-220-33 33 cm
 51-220-42 42 cm

51-230-30
 30 cm

51-176-33 33 cm
 51-176-42 42 cm
 malleable

51-196-33 33 cm
 51-196-42 42 cm
 malleable

51-206-33 33 cm
 51-206-42 42 cm
 malleable

stainless steel, light weight



Freeman

51-270-34	34 mm
51-270-36	36 mm
51-270-38	38 mm
51-270-42	42 mm
51-270-45	45 mm
51-270-50	50 mm

stainless steel, double sided, 2 sizes



Freeman

51-274-34	34 / 36 mm
51-274-38	38 / 42 mm
51-274-42	42 / 45 mm
51-274-45	45 / 50 mm

stainless steel, single size



Freeman

51-278-32	32 mm
51-278-34	34 mm
51-278-36	36 mm
51-278-38	38 mm
51-278-42	42 mm
51-278-45	45 mm
51-278-50	50 mm



aluminium, 4 sizes in 1



Grossmann

51-282-40	40 / 44 / 48 / 52 mm
-----------	----------------------

aluminium, 2 sizes



Freeman

51-286-34	34 / 36 mm
51-286-38	38 / 42 mm
51-286-45	45 / 50 mm

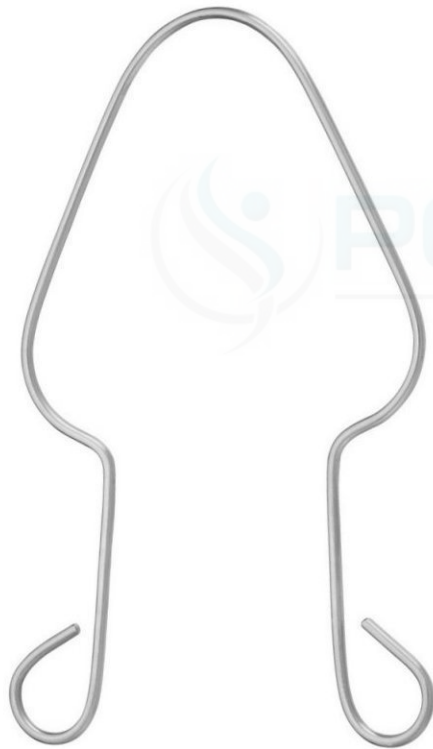

Ackermann
51-300-14 14 cm
51-300-16 16 cm



McKissock
51-306-38 38 mm
51-306-42 42 mm
51-306-45 45 mm
51-306-50 50 mm

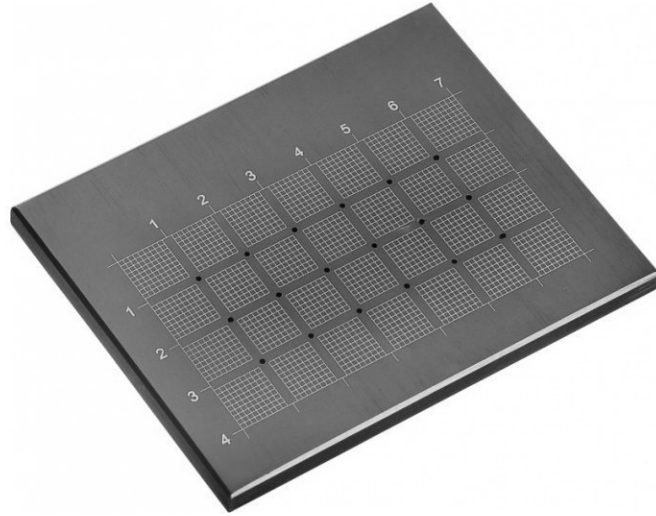

Sheen
51-340-70
70 x 40 mm



Pitanguy
51-360-14
14 cm



Pitanguy
51-366-16
16 cm

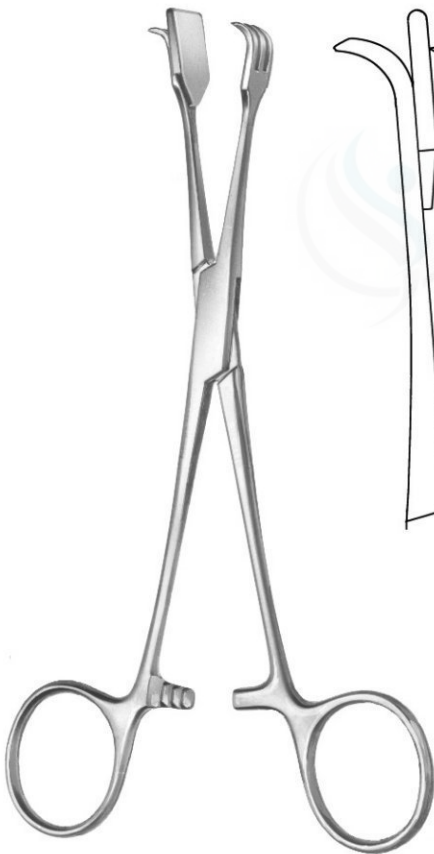

D'Assumpcao
51-370-16 with ratchet
51-372-16 w/o ratchet
16 cm



Marten
51-380-14
14 cm



Marten
51-382-14
14 cm



McKissock (Collyer)
51-400-30
30 cm



Halpren
51-410-34 34 mm
51-410-38 38 mm
51-410-42 42 mm

measuring range: 15 mm

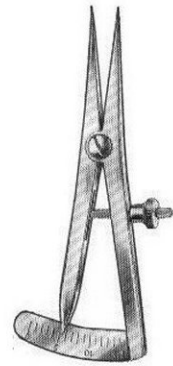

Castroviejo
27-300-06

measuring range: 20 mm

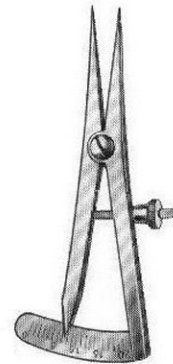

Castroviejo
27-304-06

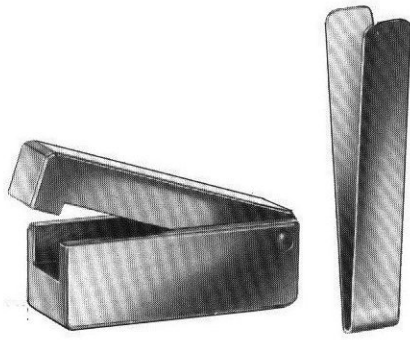

Cottle
23-662-00
65 x 30 x 30 mm



Killian
51-440-35 35 mm
51-440-50 50 mm
51-440-75 75 mm
51-440-90 90 mm
13 cm

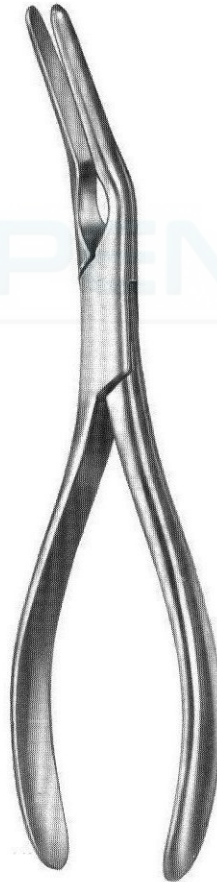

Asch
23-801-23
23 cm

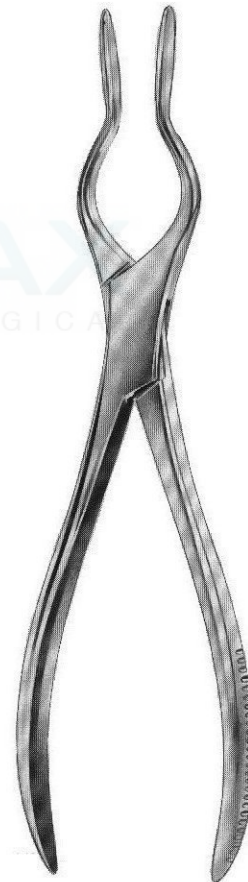

Walsham
23-806-01 - 23-806-03
23 cm



51-460-22
22 cm



Iconoclast
51-470-22 22.0 cm
51-470-29 29.5 cm



s-shaped

scalp elevators

51-500-24	51-504-24	51-510-24	51-512-24	51-514-24	51-516-24	51-520-24	51-522-24
24 cm	24 cm	24 cm	24 cm	24 cm	24 cm	24 cm	24 cm
12.5 mm	12.5 mm	15 mm	15 mm	15 mm	15 mm	12.5 mm	12.5 mm
51-502-24	51-506-24						
24 cm	24 cm						
12.5 mm	12.5 mm						
s-shaped	s-shaped						

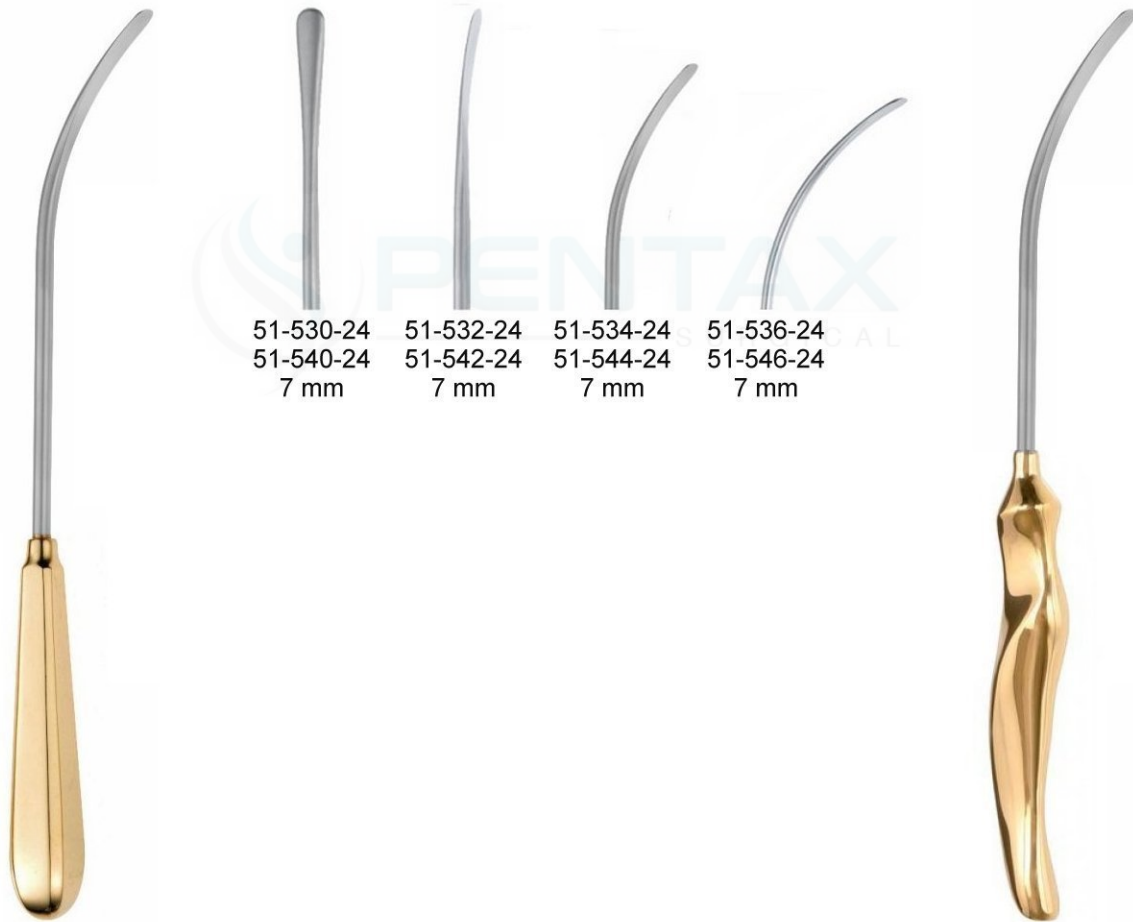

51-530-24	51-532-24	51-534-24	51-536-24
51-540-24	51-542-24	51-544-24	51-546-24
7 mm	7 mm	7 mm	7 mm

----- scalp elevators -----

51-530-24 - 51-536-24	51-540-24 - 51-546-24
24 cm	24 cm



----- scalp elevators with suction -----

51-560-24
24 cm
7 mm

51-560-26
26 cm
8.5 mm

Daniel
51-564-23
23.5 cm



----- flap -----		----- frontotemporal -----					
51-590-23	51-592-23	51-596-22	51-598-22	51-600-23	51-602-23	51-610-23	51-612-23
23.5 cm	23.5 cm	22.5 cm	22.5 cm	23 cm	23 cm	23 cm	23 cm
5 mm	5 mm	5 mm	5 mm	7 mm	7 mm	10 mm	10 mm

s-shaped



-- frontoglabella --

51-630-26	51-632-26
26.5 cm	26.5 cm
7 mm	7 mm

-- zygomatic arch --

51-640-20	51-642-20
20.5 cm	20.5 cm
5 mm	5 mm

----- orbital rim -----

51-650-22	51-652-22
22.5 cm	22.5 cm

----- temporal -----

51-660-23	51-662-23
23.5 cm	23.5 cm
10 mm	10 mm

s-shaped



-- periosteal elevators --

51-680-25	51-682-25
25 cm	25 cm
12 mm	12 mm

----- periosteal spreaders -----

51-690-24	51-692-24	51-700-24	51-702-24
24 cm	24 cm	24 cm	24 cm
8 mm	8 mm	10 mm	10 mm

s-shaped

multiple curves



-- arcus marginalis --

51-720-24	51-722-24
24 cm	24 cm
10 mm	10 mm



-- midface facial --

51-730-24	51-732-24
24 cm	24 cm
12 mm	12 mm



---- transoral ----

51-740-23	51-742-23
23.5 cm	23.5 cm



- nerve dissector -

51-760-24	51-762-24
24 cm	24 cm
4.7 mm	4.7 mm



----- nerve hook -----

51-770-24	51-772-24
24 cm	24 cm
left	left



51-776-24	51-778-24
24 cm	24 cm
right	right



Del Campo
51-790-21
21 cm

Del Campo
51-792-21
21 cm

Gravier
51-800-31
31.5cm

Gravier
51-802-31
31.5cm



--- nerve protector ---

- nerve cutting -

- knife handle -

- nerve hook -

51-840-19
19.5 cm
4.7 mm

51-850-01
17 cm
4.5 mm

51-850-02
17 cm
4.5 mm

51-860-17
17 cm
3 mm

51-870-20
20.5 cm

51-880-24 rigid
51-882-24 malleable
24 cm



Light Guide Cable

	black	gray		
51-920-01	51-922-01	183 cm	Ø 3.5 mm	GAL
51-920-02	51-922-02	229 cm	Ø 3.5 mm	
51-920-03	51-922-03	183 cm	Ø 5.0 mm	
51-920-04	51-922-04	229 cm	Ø 5.0 mm	

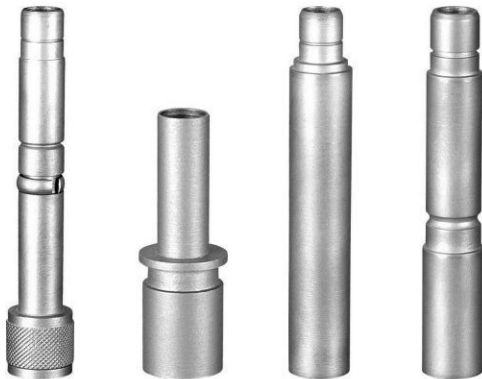

-- light source end adaptors for cables --

Olympus 51-930-01 Storz 51-930-02 Acmi 51-930-03 Wolf 51-930-04



-- instruments end adaptors for cables --

Storz 51-936-01 Acmi 51-936-02 Wolf 51-936-03

N	
Nasal Retractors	50-5, 50-16
Nasal Specula	51-9
Nerve Cutting Knife	51-20
Nerve Dissectors	51-18
Nerve Hook	51-18
Nerve Hook	51-20
Nerve Protector	51-20

O	
Orbital Retractors	50-16
Orbital Rim Dissectors	51-15
Oval Spatulated Dissectors	51-3

P	
Periosteal Elevators	51-16
Periosteal Spreaders	51-16
Petri Pterygoid Intra Oral Fiber Optic Retractors	50-8
Petri Pterygoid Intra Oral Retractors	50-8
Pitanguy Facial Dermarcator Forceps	51-6
Pitanguy Flap Grasping Forceps	51-6

R	
Rake Retractors	50-12 – 50-13
Retractors	50-11 – 50-17
Retractors for Vertical Osteotomies	50-10
Reynolds Transaxillary Breast Dissectors	51-2
Rigid Breast Dissectors	51-3

S	
Scalp Elevators	51-11 – 51-12
Scalp Elevators with Suction	51-13
Septum Forceps	51-9
Shea Multipurpose Fiber Optic Retractors	50-10
Sheen Grid	51-6
Sheen Nasal Retractors	50-16
Sheen Retractors	50-16
Shoe Horn Retractors	50-17
Sigmoid Notch Extra Oral Fiber Optic Retractors	50-8
Sigmoid Notch Extra Oral Retractors	50-8
Skin Hooks	50-15
Spatulated Dissectors	51-2 – 51-3
Speculas	51-9
Stainless Steel Areola Markers	51-4
Submammary Dissectors	51-2

T	
Tebbets Style Fiber Optic Retractors	50-2
Temporal T-Dissectors	51-15
Thimble Hooks	50-15
Tongue Depressors	50-6
Transaxillary Breast Dissectors	51-2
Transoral Dissectors	51-17

W	
Walsham Septum Forceps	51-9
Wieder Tongue Depressors	50-6
Wieder Tongue Depressors with Fiber Optic	50-6
Wise Orbital Retractors	50-16

Y	
Yancoskie Abdominoplasty Retractors	50-14

Z	
Zygomatic Arch Elevators	51-15

THANK YOU



CONTACT US



www.pentaxsurgical.com



pentaxsurgical@gmail.com
info@pentaxsurgical.com



+92-328 01 66 200

Visit Alibaba Site:

