

Manufacturer Of all kind of Neuro and Spine Instruments



PRODUCT CATALOG

NEURO SPINE INSTRUMENTS



COMPANY PROFILE

ABOUT US

WELCOME TO PENTAX SURGICAL

Established in 2008, PENTAX SURGICAL is on a mission to redefine the industry by proving that quality doesn't have to be sacrificed for competitiveness. Our commitment revolves around producing high-quality instruments at prices that keep you smiling. From our humble beginnings as a family-run veriore, we've evolved into a significant player in the market.

Our mission is clear to instill confidence in our clients by delivering Instruments of the highest quality at prices that make sense. We understand that the key to succes lies in customer satisfaction and loyalty, which forms the core of our vision. As we grow, our focus reamins on fostering strong relatoriships with our customers

At PENTAX SURGICAL, we firmly believe that quality is never accidental, it's the outcome of thoughtful and intelligent effort Each instrument we produce reflects this commitment to excellence, ensuring you receive products that exceed expectations. Join us on our journey as we continue to set new standards in quality and customer satisfaction.

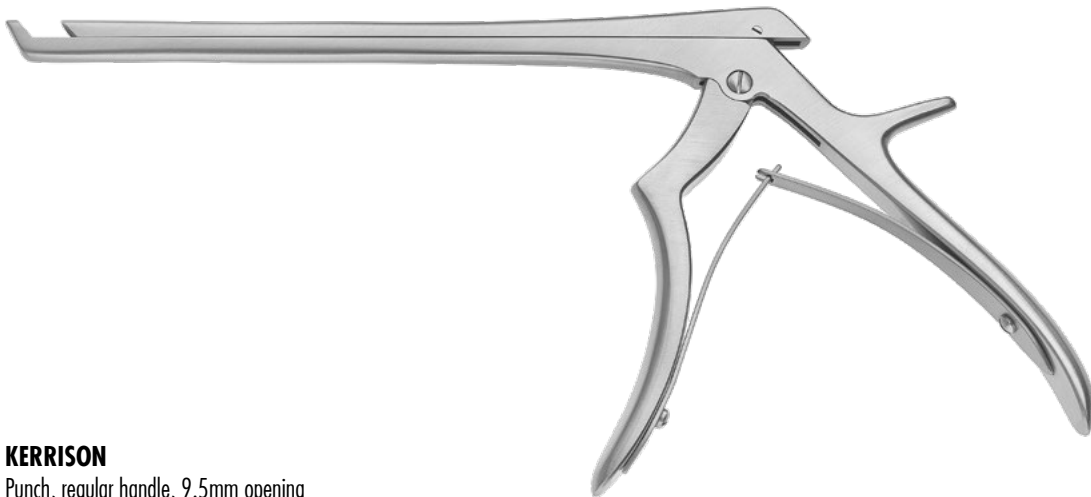

KERRISON

Punch, regular handle, 9.5mm opening



40° upwards cutting
180mm, 7"

1mm	250-400-181
2mm	250-400-182
3mm	250-400-183
4mm	250-400-184
5mm	250-400-185
6mm	250-400-186

200mm, 8"

1mm	250-400-201
2mm	250-400-202
3mm	250-400-203
4mm	250-400-204
5mm	250-400-205
6mm	250-400-206

230mm, 9"

1mm	250-400-231
2mm	250-400-232
3mm	250-400-233
4mm	250-400-234
5mm	250-400-235
6mm	250-400-236



90° upwards cutting
180mm, 7"

1mm	250-410-181
2mm	250-410-182
3mm	250-410-183
4mm	250-410-184
5mm	250-410-185
6mm	250-410-186

200mm, 8"

1mm	250-410-201
2mm	250-410-202
3mm	250-410-203
4mm	250-410-204
5mm	250-410-205
6mm	250-410-206

230mm, 9"

1mm	250-410-231
2mm	250-410-232
3mm	250-410-233
4mm	250-410-234
5mm	250-410-235
6mm	250-410-236



40° downwards cutting
180mm, 7"

1mm	250-420-181
2mm	250-420-182
3mm	250-420-183
4mm	250-420-184
5mm	250-420-185
6mm	250-420-186

200mm, 8"

1mm	250-420-201
2mm	250-420-202
3mm	250-420-203
4mm	250-420-204
5mm	250-420-205
6mm	250-420-206

230mm, 9"

1mm	250-420-231
2mm	250-420-232
3mm	250-420-233
4mm	250-420-234
5mm	250-420-235
6mm	250-420-236



90° downwards cutting
180mm, 7"

1mm	250-430-181
2mm	250-430-182
3mm	250-430-183
4mm	250-430-184
5mm	250-430-185
6mm	250-430-186

200mm, 8"

1mm	250-430-201
2mm	250-430-202
3mm	250-430-203
4mm	250-430-204
5mm	250-430-205
6mm	250-430-206

230mm, 9"

1mm	250-430-231
2mm	250-430-232
3mm	250-430-233
4mm	250-430-234
5mm	250-430-235
6mm	250-430-236

All Kerrison instruments are available with CERACUT® coating. Code number + CC (e.g. 250-400-181CC)

KERRISON

 Punch, large handle,
 15.5mm opening

 40° upwards cutting
 180mm, 7"

1mm	250-450-181
2mm	250-450-182
3mm	250-450-183
4mm	250-450-184
5mm	250-450-185
6mm	250-450-186

200mm, 8"

1mm	250-450-201
2mm	250-450-202
3mm	250-450-203
4mm	250-450-204
5mm	250-450-205
6mm	250-450-206

230mm, 9"

1mm	250-450-231
2mm	250-450-232
3mm	250-450-233
4mm	250-450-234
5mm	250-450-235
6mm	250-450-236

 90° upwards cutting
 180mm, 7"

1mm	250-460-181
2mm	250-460-182
3mm	250-460-183
4mm	250-460-184
5mm	250-460-185
6mm	250-460-186

200mm, 8"

1mm	250-460-201
2mm	250-460-202
3mm	250-460-203
4mm	250-460-204
5mm	250-460-205
6mm	250-460-206

230mm, 9"

1mm	250-460-231
2mm	250-460-232
3mm	250-460-233
4mm	250-460-234
5mm	250-460-235
6mm	250-460-236

 40° downwards cutting
 180mm, 7"

1mm	250-470-181
2mm	250-470-182
3mm	250-470-183
4mm	250-470-184
5mm	250-470-185
6mm	250-470-186

200mm, 8"

1mm	250-470-201
2mm	250-470-202
3mm	250-470-203
4mm	250-470-204
5mm	250-470-205
6mm	250-470-206

230mm, 9"

1mm	250-470-231
2mm	250-470-232
3mm	250-470-233
4mm	250-470-234
5mm	250-470-235
6mm	250-470-236

 90° downwards cutting
 180mm, 7"

1mm	250-480-181
2mm	250-480-182
3mm	250-480-183
4mm	250-480-184
5mm	250-480-185
6mm	250-480-186

200mm, 8"

1mm	250-480-201
2mm	250-480-202
3mm	250-480-203
4mm	250-480-204
5mm	250-480-205
6mm	250-480-206

230mm, 9"

1mm	250-480-231
2mm	250-480-232
3mm	250-480-233
4mm	250-480-234
5mm	250-480-235
6mm	250-480-236

All Kerrison instruments are available with CERACUT® coating. Code number + CC (e.g. 250-400-181CC)

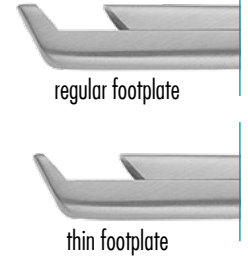
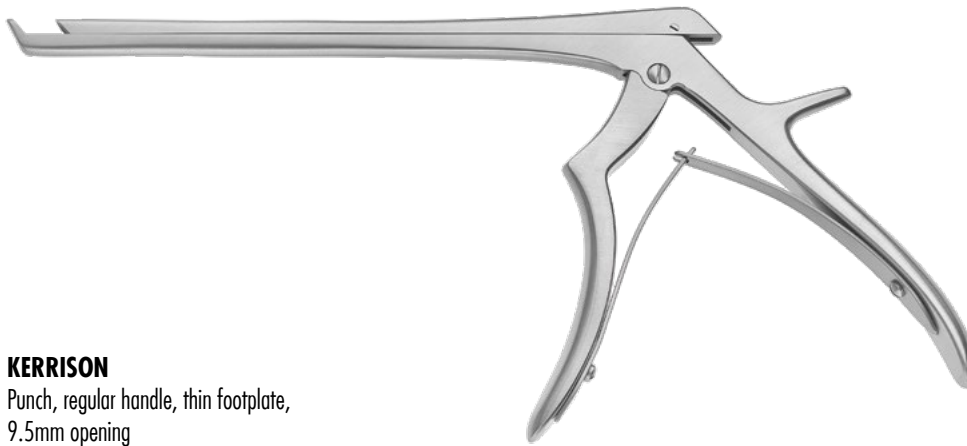

KERRISON

Punch, regular handle, thin footplate,
 9.5mm opening

40° upwards cutting 180mm, 7"		90° upwards cutting 180mm, 7"		40° downwards cutting 180mm, 7"		90° downwards cutting 180mm, 7"	
1mm	250-401-181	1mm	250-411-181	1mm	250-421-181	1mm	250-431-181
2mm	250-401-182	2mm	250-411-182	2mm	250-421-182	2mm	250-431-182
3mm	250-401-183	3mm	250-411-183	3mm	250-421-183	3mm	250-431-183
4mm	250-401-184	4mm	250-411-184	4mm	250-421-184	4mm	250-431-184
5mm	250-401-185	5mm	250-411-185	5mm	250-421-185	5mm	250-431-185
200mm, 8"		200mm, 8"		200mm, 8"		200mm, 8"	
1mm	250-401-201	1mm	250-411-201	1mm	250-421-201	1mm	250-431-201
2mm	250-401-202	2mm	250-411-202	2mm	250-421-202	2mm	250-431-202
3mm	250-401-203	3mm	250-411-203	3mm	250-421-203	3mm	250-431-203
4mm	250-401-204	4mm	250-411-204	4mm	250-421-204	4mm	250-431-204
5mm	250-401-205	5mm	250-411-205	5mm	250-421-205	5mm	250-431-205
230mm, 9"		230mm, 9"		230mm, 9"		230mm, 9"	
1mm	250-401-231	1mm	250-411-231	1mm	250-421-231	1mm	250-431-231
2mm	250-401-232	2mm	250-411-231	2mm	250-421-231	2mm	250-431-231
3mm	250-401-233	3mm	250-411-231	3mm	250-421-231	3mm	250-431-231
4mm	250-401-234	4mm	250-411-231	4mm	250-421-231	4mm	250-431-231
5mm	250-401-235	5mm	250-411-231	5mm	250-421-231	5mm	250-431-231

All Kerrison instruments are available with CERACUT® coating. Code number + CC (e.g. 250-400-181CC)

KERRISON

Punch, regular handle, superflat footplate

 180mm, 7"
 40° upwards cutting

1mm	250-400-181SF
1.5mm	250-400-189SF
2mm	250-400-182SF
3mm	250-400-183SF
4mm	250-400-184SF
5mm	250-400-185SF
6mm	250-400-186SF

 180mm, 7"
 40° upwards cutting,
 standard ejector

2mm	250-400-182ESF
3mm	250-400-183ESF
4mm	250-400-184ESF
5mm	250-400-185ESF
6mm	250-400-186ESF

 180mm, 7"
 40° upwards cutting, CERA-CUT®

1mm	250-400-181SFCC
2mm	250-400-182SFCC
3mm	250-400-183SFCC
4mm	250-400-184SFCC
5mm	250-400-185SFCC
6mm	250-400-186SFCC

200mm, 8"

1mm	250-400-201SF
1.5mm	250-400-209SF
2mm	250-400-202SF
3mm	250-400-203SF
4mm	250-400-204SF
5mm	250-400-205SF
6mm	250-400-206SF

200mm, 8"

2mm	250-400-202ESF
3mm	250-400-203ESF
4mm	250-400-204ESF
5mm	250-400-205ESF
6mm	250-400-206ESF

200mm, 8"

1mm	250-400-201SFCC
2mm	250-400-202SFCC
3mm	250-400-203SFCC
4mm	250-400-204SFCC
5mm	250-400-205SFCC
6mm	250-400-206SFCC

230mm, 9"

1mm	250-400-231SF
1.5mm	250-400-239SF
2mm	250-400-232SF
3mm	250-400-233SF
4mm	250-400-234SF
5mm	250-400-235SF
6mm	250-400-236SF

230mm, 9"

2mm	250-400-232ESF
3mm	250-400-233ESF
4mm	250-400-234ESF
5mm	250-400-235ESF
6mm	250-400-236ESF

230mm, 9"

1mm	250-400-231SFCC
2mm	250-400-232SFCC
3mm	250-400-233SFCC
4mm	250-400-234SFCC
5mm	250-400-235SFCC
6mm	250-400-236SFCC

All Kerrison instruments are available with coating. Code number + CC (e.g. 250-400-181CC)

KERRISON

Punch, regular handle, superflat footplate

 180mm, 7"
 90° upwards cutting

1mm	250-411-181SF
2mm	250-411-182SF
3mm	250-411-183SF
4mm	250-411-184SF
5mm	250-411-185SF
6mm	250-411-186SF

 180mm, 7"
 90° upwards cutting,
 standard ejector

2mm	250-411-182ESF
3mm	250-411-183ESF
4mm	250-411-184ESF
5mm	250-411-185ESF
6mm	250-411-186ESF

 180mm, 7"
 90° upwards cutting, CERA-CUT®

1mm	250-411-181SFCC
2mm	250-411-182SFCC
3mm	250-411-183SFCC
4mm	250-411-184SFCC
5mm	250-411-185SFCC
6mm	250-411-186SFCC

200mm, 8"

1mm	250-411-201SF
2mm	250-411-202SF
3mm	250-411-203SF
4mm	250-411-204SF
5mm	250-411-205SF
6mm	250-411-206SF

200mm, 8"

2mm	250-411-202ESF
3mm	250-411-203ESF
4mm	250-411-204ESF
5mm	250-411-205ESF
6mm	250-411-206ESF

200mm, 8"

1mm	250-411-201SFCC
2mm	250-411-202SFCC
3mm	250-411-203SFCC
4mm	250-411-204SFCC
5mm	250-411-205SFCC
6mm	250-411-206SFCC

230mm, 9"

1mm	250-411-231SF
2mm	250-411-232SF
3mm	250-411-233SF
4mm	250-411-234SF
5mm	250-411-235SF
6mm	250-411-236SF

230mm, 9"

2mm	250-411-232ESF
3mm	250-411-233ESF
4mm	250-411-234ESF
5mm	250-411-235ESF
6mm	250-411-236ESF

230mm, 9"

1mm	250-411-231SFCC
2mm	250-411-232SFCC
3mm	250-411-233SFCC
4mm	250-411-234SFCC
5mm	250-411-235SFCC
6mm	250-411-236SFCC

All Kerrison instruments are available with CERACUT® coating. Code number + CC (e.g. 250-400-181CC)

KERRISON

Long Anterior Punch, regular handle,
 9.5mm opening,
 40° upwards cutting

15.5mm opening,
 40° upwards cutting

250mm, 9 ⁷ / ₈ "		280mm, 11"		250mm, 9 ⁷ / ₈ "		280mm, 11"	
2mm	250-400-252	2mm	250-400-282	2mm	250-450-252	2mm	250-450-282
3mm	250-400-253	3mm	250-400-283	3mm	250-450-253	3mm	250-450-283
4mm	250-400-254	4mm	250-400-284	4mm	250-450-254	4mm	250-450-284
5mm	250-400-255	5mm	250-400-285	5mm	250-450-255	5mm	250-450-285
6mm	250-400-256	6mm	250-400-286	6mm	250-450-256	6mm	250-450-286

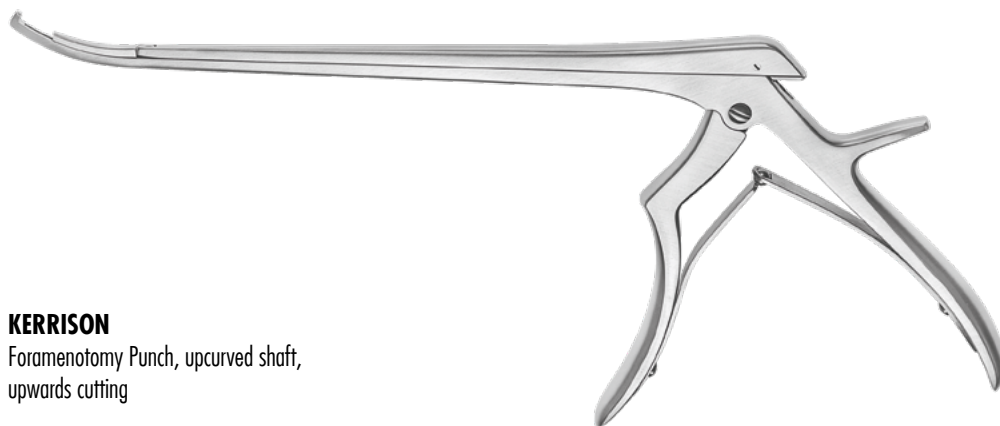
KERRISON

Foramenotomy Punch, upcurved shaft,
 upwards cutting

180mm, 7"		200mm, 8"	
2mm	210-728-002	2mm	210-728-102
3mm	210-728-003	3mm	210-728-103
4mm	210-728-004	4mm	210-728-104

All Kerrison instruments are available with coating. Code number + CC (e.g. 250-400-181CC)

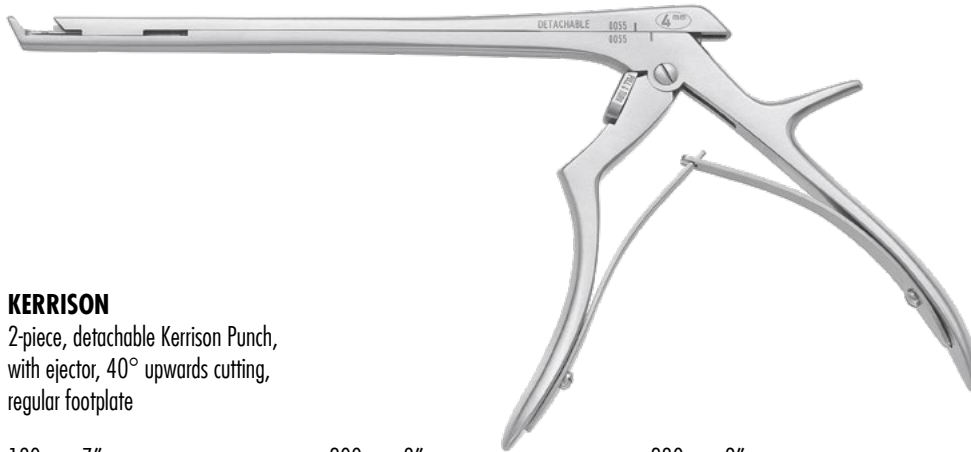
KERRISON

2-piece, detachable Kerrison Punch,
 with ejector, 40° upwards cutting,
 regular footplate

180mm, 7"		200mm, 8"		230mm, 9"	
1mm	250-500-181	1mm	250-500-201	1mm	250-500-231
2mm	250-500-182	2mm	250-500-202	2mm	250-500-232
3mm	250-500-183	3mm	250-500-203	3mm	250-500-233
4mm	250-500-184	4mm	250-500-204	4mm	250-500-234
5mm	250-500-185	5mm	250-500-205	5mm	250-500-235
6mm	250-500-186	6mm	250-500-206	6mm	250-500-236

thin footplate 180mm, 7"		thin footplate 200mm, 8"		thin footplate 230mm, 9"	
1mm	250-510-181	1mm	250-510-201	1mm	250-510-231
2mm	250-510-182	2mm	250-510-202	2mm	250-510-232
3mm	250-510-183	3mm	250-510-203	3mm	250-510-233
4mm	250-510-184	4mm	250-510-204	4mm	250-510-234

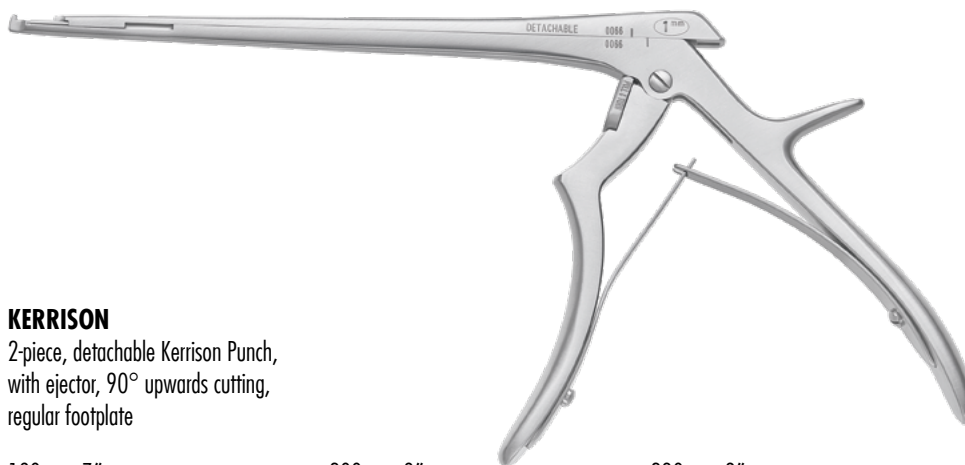
KERRISON

2-piece, detachable Kerrison Punch,
 with ejector, 90° upwards cutting,
 regular footplate

180mm, 7"		200mm, 8"		230mm, 9"	
1mm	250-590-181	1mm	250-590-201	1mm	250-590-231
2mm	250-590-182	2mm	250-590-202	2mm	250-590-232
3mm	250-590-183	3mm	250-590-203	3mm	250-590-233
4mm	250-590-184	4mm	250-590-204	4mm	250-590-234
5mm	250-590-185	5mm	250-590-205	5mm	250-590-235
6mm	250-590-186	6mm	250-590-206	6mm	250-590-236

All Kerrison instruments are available with coating. Code number + CC (e.g. 250-400-181CC)

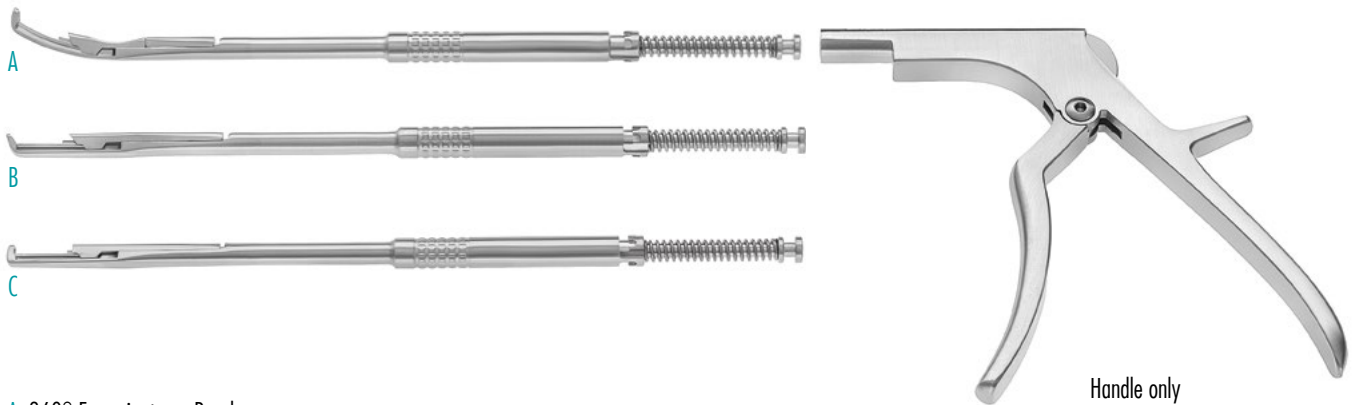

Handle only

250-245-000

A 360° Foraminotomy Punch
 exchangeable shaft, ejector, thin footplate
 40° angled

180mm, 7"		200mm, 8"		230mm, 9"		250mm, 9 ⁷ / ₈ "	
2mm	250-280-182	2mm	250-280-202	2mm	250-280-232	2mm	250-280-252
3mm	250-280-183	3mm	250-280-203	3mm	250-280-233	3mm	250-280-253
4mm	250-280-184	4mm	250-280-204	4mm	250-280-234	4mm	250-280-254
5mm	250-280-185	5mm	250-280-205	5mm	250-280-235	5mm	250-280-255

B 360° Laminectomy Punch
 exchangeable shaft, ejector, thin footplate
 40° angled

180mm, 7"		200mm, 8"		230mm, 9"		250mm, 9 ⁷ / ₈ "	
1mm	250-210-181	1mm	250-210-201	1mm	250-210-231	1mm	250-210-251
1.5mm	250-210-180	1.5mm	250-210-200	2mm	250-210-232	2mm	250-210-252
2mm	250-210-182	2mm	250-210-202	3mm	250-210-233	3mm	250-210-253
3mm	250-210-183	3mm	250-210-203	4mm	250-210-234	4mm	250-210-254
4mm	250-210-183	4mm	250-210-204	5mm	250-210-235	5mm	250-210-255
5mm	250-210-185	5mm	250-210-205				

C 360° Laminectomy Punch
 exchangeable shaft, ejector, thin footplate
 90° angled

180mm, 7"		200mm, 8"		230mm, 9"		250mm, 9 ⁷ / ₈ "	
1mm	250-245-181	1mm	250-245-201	1mm	250-245-231	1mm	250-245-251
1.5mm	250-245-180	1.5mm	250-245-200	2mm	250-245-232	2mm	250-245-252
2mm	250-245-182	2mm	250-245-202	3mm	250-245-233	3mm	250-245-253
3mm	250-245-183	3mm	250-245-203	4mm	250-245-234	4mm	250-245-254
4mm	250-245-184	4mm	250-245-204	5mm	250-245-235	5mm	250-245-255
5mm	250-245-185	5mm	250-245-205				

All Kerrison instruments are available with CERACUT® coating. Code number + CC (e.g. 250-400-181CC)

KERRISON
 Kerrison Swivel Punch
 2-piece detachable punch

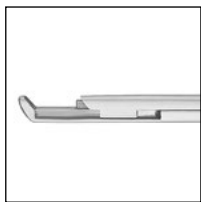

Regular footplate
 40° upwards cutting



Regular footplate
 90° upwards cutting



Regular footplate
 40° downwards cutting

180mm, 7"		200mm, 8"		230mm, 9"	
1mm	250-600-181	1mm	250-600-201	1mm	250-600-231
2mm	250-600-182	2mm	250-600-202	2mm	250-600-232
3mm	250-600-183	3mm	250-600-203	3mm	250-600-233
4mm	250-600-184	4mm	250-600-204	4mm	250-600-234
5mm	250-600-185	5mm	250-600-205	5mm	250-600-235
6mm	250-600-186	6mm	250-600-206	6mm	250-600-236

180mm, 7"		200mm, 8"		230mm, 9"	
1mm	250-640-181	1mm	250-640-201	1mm	250-640-231
2mm	250-640-182	2mm	250-640-202	2mm	250-640-232
3mm	250-640-183	3mm	250-640-203	3mm	250-640-233
4mm	250-640-184	4mm	250-640-204	4mm	250-640-234
5mm	250-640-185	5mm	250-640-205	5mm	250-640-235
6mm	250-640-186	6mm	250-640-206	6mm	250-640-236

180mm, 7"		200mm, 8"		230mm, 9"	
1mm	250-630-181	1mm	250-630-201	1mm	250-630-231
2mm	250-630-182	2mm	250-630-202	2mm	250-630-232
3mm	250-630-183	3mm	250-630-203	3mm	250-630-233
4mm	250-630-184	4mm	250-630-204	4mm	250-630-234
5mm	250-630-185	5mm	250-630-205	5mm	250-630-235
6mm	250-630-186	6mm	250-630-206	6mm	250-630-236

All instruments are available with CERACUT® coating. Code number + CC (e.g. 250-600-181CC)

KERRISON

 Kerrison Swivel Punch
 2-piece detachable punch

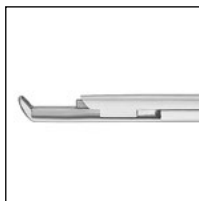
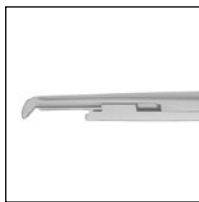
 Regular footplate
 90° downwards cutting

 Thin footplate
 40° upwards cutting

 Thin footplate
 40° downwards cutting

 Foramenotomy
 40° upwards cutting

180mm, 7"		200mm, 8"		230mm, 9"	
1mm	250-660-181	1mm	250-660-201	1mm	250-660-231
2mm	250-660-182	2mm	250-660-202	2mm	250-660-232
3mm	250-660-183	3mm	250-660-203	3mm	250-660-233
4mm	250-660-184	4mm	250-660-204	4mm	250-660-234
5mm	250-660-185	5mm	250-660-205	5mm	250-660-235
6mm	250-660-186	6mm	250-660-206	6mm	250-660-236

180mm, 7"		200mm, 8"		230mm, 9"	
1mm	250-610-181	1mm	250-610-201	1mm	250-610-231
2mm	250-610-182	2mm	250-610-202	2mm	250-610-232
3mm	250-610-183	3mm	250-610-203	3mm	250-610-233
4mm	250-610-184	4mm	250-610-204	4mm	250-610-234
5mm	250-610-185	5mm	250-610-205	5mm	250-610-235
6mm	250-610-186	6mm	250-610-206	6mm	250-610-236

180mm, 7"		200mm, 8"		230mm, 9"	
1mm	250-620-181	1mm	250-620-201	1mm	250-620-231
2mm	250-620-182	2mm	250-620-202	2mm	250-620-232
3mm	250-620-183	3mm	250-620-203	3mm	250-620-233
4mm	250-620-184	4mm	250-620-204	4mm	250-620-234
5mm	250-620-185	5mm	250-620-205	5mm	250-620-235
6mm	250-620-186	6mm	250-620-206	6mm	250-620-236

180mm, 7"		200mm, 8"	
1mm	250-680-181	1mm	250-680-201
2mm	250-680-182	2mm	250-680-202
3mm	250-680-183	3mm	250-680-203
4mm	250-680-184	4mm	250-680-204
5mm	250-680-185	5mm	250-680-205
6mm	250-680-186	6mm	250-680-206

All instruments are available with CERACUT® coating. Code number + CC (e.g. 250-600-181CC)

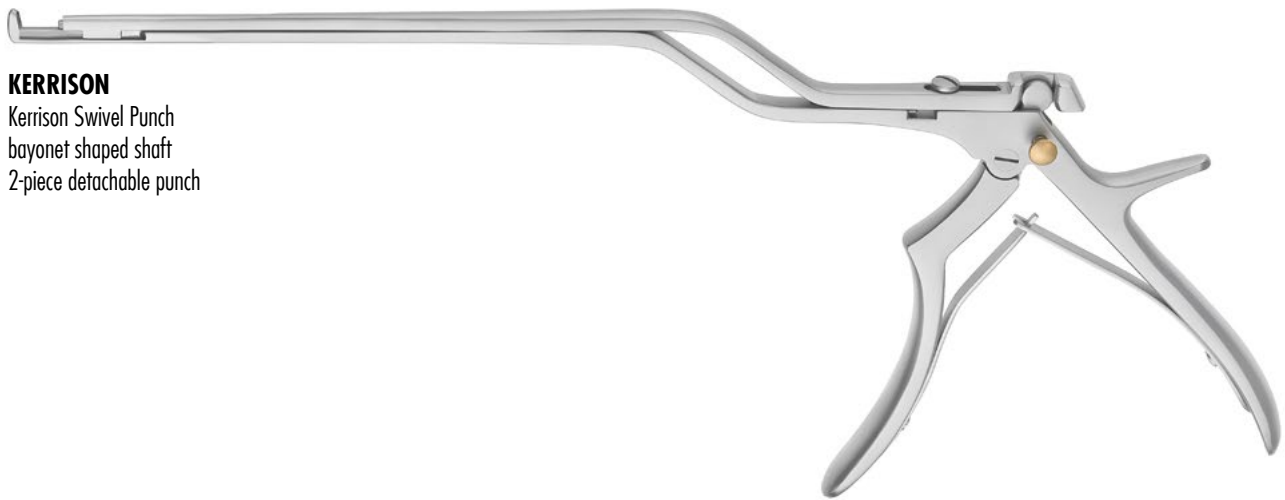

KERRISON

Kerrison Swivel Punch
 bayonet shaped shaft
 2-piece detachable punch

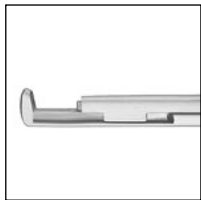

90° upwards cutting

180mm, 7"	
1mm	250-650-111
2mm	250-650-112
3mm	250-650-113
4mm	250-650-114
5mm	250-650-115
6mm	250-650-116

200mm, 8"	
1mm	250-650-151
2mm	250-650-152
3mm	250-650-153
4mm	250-650-154
5mm	250-650-155
6mm	250-650-156

230mm, 9"	
1mm	250-650-181
2mm	250-650-182
3mm	250-650-183
4mm	250-650-184
5mm	250-650-185
6mm	250-650-186



90° upwards cutting
 left curved jaw

180mm, 7"	
1mm	250-651-111
2mm	250-651-112
3mm	250-651-113
4mm	250-651-114
5mm	250-651-115
6mm	250-651-116

200mm, 8"	
1mm	250-651-151
2mm	250-651-152
3mm	250-651-153
4mm	250-651-154
5mm	250-651-155
6mm	250-651-156

230mm, 9"	
1mm	250-651-181
2mm	250-651-182
3mm	250-651-183
4mm	250-651-184
5mm	250-651-185
6mm	250-651-186



90° upwards cutting
 right curved jaw

180mm, 7"	
1mm	250-652-111
2mm	250-652-112
3mm	250-652-113
4mm	250-652-114
5mm	250-652-115
6mm	250-652-116

200mm, 8"	
1mm	250-652-151
2mm	250-652-152
3mm	250-652-153
4mm	250-652-154
5mm	250-652-155
6mm	250-652-156

230mm, 9"	
1mm	250-652-181
2mm	250-652-182
3mm	250-652-183
4mm	250-652-184
5mm	250-652-185
6mm	250-652-186

All instruments are available with CERACUT® coating. Code number + CC (e.g. 250-600-181CC)

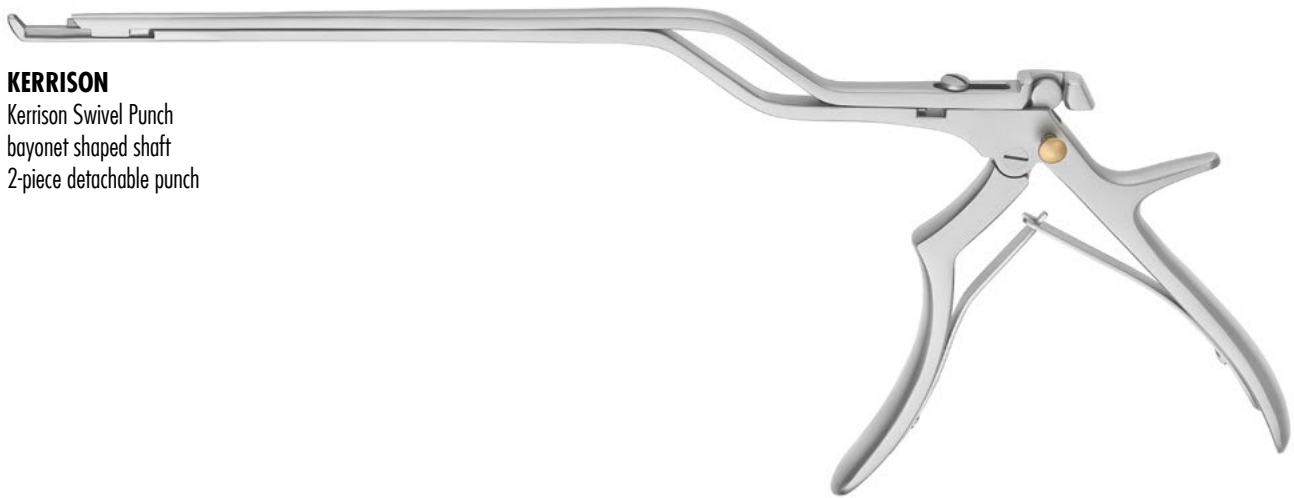

KERRISON

Kerrison Swivel Punch
 bayonet shaped shaft
 2-piece detachable punch

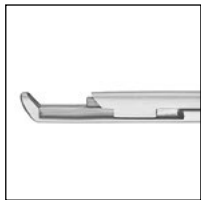

40° upwards cutting

180mm, 7"		200mm, 8"		230mm, 9"	
1mm	250-641-111	1mm	250-641-151	1mm	250-641-181
2mm	250-641-112	2mm	250-641-152	2mm	250-641-182
3mm	250-641-113	3mm	250-641-153	3mm	250-641-183
4mm	250-641-114	4mm	250-641-154	4mm	250-641-184
5mm	250-641-115	5mm	250-641-155	5mm	250-641-185
6mm	250-641-116	6mm	250-641-156	6mm	250-641-186



40° upwards cutting
 left curved jaw

180mm, 7"		200mm, 8"		230mm, 9"	
1mm	250-643-111	1mm	250-643-151	1mm	250-643-181
2mm	250-643-112	2mm	250-643-152	2mm	250-643-182
3mm	250-643-113	3mm	250-643-153	3mm	250-643-183
4mm	250-643-114	4mm	250-643-154	4mm	250-643-184
5mm	250-643-115	5mm	250-643-155	5mm	250-643-185
6mm	250-643-116	6mm	250-643-156	6mm	250-643-186



40° upwards cutting
 right curved jaw

180mm, 7"		200mm, 8"		230mm, 9"	
1mm	250-642-111	1mm	250-642-151	1mm	250-642-181
2mm	250-642-112	2mm	250-642-152	2mm	250-642-182
3mm	250-642-113	3mm	250-642-153	3mm	250-642-183
4mm	250-642-114	4mm	250-642-154	4mm	250-642-184
5mm	250-642-115	5mm	250-642-155	5mm	250-642-185
6mm	250-642-116	6mm	250-642-156	6mm	250-642-186

All instruments are available with CERACUT® coating. Code number + CC (e.g. 250-600-181CC)



KERRISON

Kerrison Swivel Punch
bayonet shaped shaft
black finish, handle with silicone coating



40° upwards cutting

140mm, 5¹/₂" working length

1mm	250-000-001
2mm	250-000-002
3mm	250-000-003
4mm	250-000-004
5mm	250-000-005



90° upwards cutting

140mm, 5¹/₂" working length

1mm	250-000-006
2mm	250-000-007
3mm	250-000-008
4mm	250-000-009
5mm	250-000-010

Disc Rongeurs

MINI-CUSHING

1.5x10mm bite

180mm, 7"	250-100-181
200mm, 8"	250-100-201

CUSHING

2x10mm bite

130mm, 5 ¹ / ₈ "	250-100-132
150mm, 6"	250-100-152
180mm, 7"	250-100-182
200mm, 8"	250-100-202
230mm, 9"	250-100-232



1.5x10mm bite

180mm, 7"	250-110-181
200mm, 8"	250-110-201

2x10mm bite

130mm, 5 ¹ / ₈ "	250-110-132
150mm, 6"	250-110-152
180mm, 7"	250-110-182
200mm, 8"	250-110-202
230mm, 9"	250-110-232



1.5x10mm bite

180mm, 7"	250-120-181
200mm, 8"	250-120-201

2x10mm bite

130mm, 5 ¹ / ₈ "	250-120-132
150mm, 6"	250-120-152
180mm, 7"	250-120-182
200mm, 8"	250-120-202
230mm, 9"	250-120-232

Laminectomy Rongeurs

LOVE GRUENWALD

straight, 3x10mm bite

130mm, 5 ¹ / ₈ "	250-100-133
150mm, 6"	250-100-153
180mm, 7"	250-100-183
200mm, 8"	250-100-203
230mm, 9"	250-100-233

upwards curved, 3x10mm bite

130mm, 5 ¹ / ₈ "	250-110-133
150mm, 6"	250-110-153
180mm, 7"	250-110-183
200mm, 8"	250-110-203
230mm, 9"	250-110-233

downwards curved, 3x10mm bite

130mm, 5 ¹ / ₈ "	250-120-133
150mm, 6"	250-120-153
180mm, 7"	250-120-183
200mm, 8"	250-120-203
230mm, 9"	250-120-233

SPURLING

straight, 4x10mm bite

130mm, 5 ¹ / ₈ "	250-100-134
150mm, 6"	250-100-154
180mm, 7"	250-100-184
200mm, 8"	250-100-204
230mm, 9"	250-100-234

upwards curved, 5x10mm bite

130mm, 5 ¹ / ₈ "	250-110-134
150mm, 6"	250-110-154
180mm, 7"	250-110-184
200mm, 8"	250-110-204
230mm, 9"	250-110-234

downwards curved, 5x10mm bite

130mm, 5 ¹ / ₈ "	250-120-134
150mm, 6"	250-120-154
180mm, 7"	250-120-184
200mm, 8"	250-120-204
230mm, 9"	250-120-234

CASPAR

straight, 5x10mm bite

130mm, 5 ¹ / ₈ "	250-100-135
150mm, 6"	250-100-155
180mm, 7"	250-100-185
200mm, 8"	250-100-205
230mm, 9"	250-100-235

upwards curved, 5x10mm bite

130mm, 5 ¹ / ₈ "	250-110-135
150mm, 6"	250-110-155
180mm, 7"	250-110-185
200mm, 8"	250-110-205
230mm, 9"	250-110-235

downwards curved, 5x10mm bite

130mm, 5 ¹ / ₈ "	250-120-135
150mm, 6"	250-120-155
180mm, 7"	250-120-185
200mm, 8"	250-120-205
230mm, 9"	250-120-235



CASPAR

Toothed Disc Rongeurs

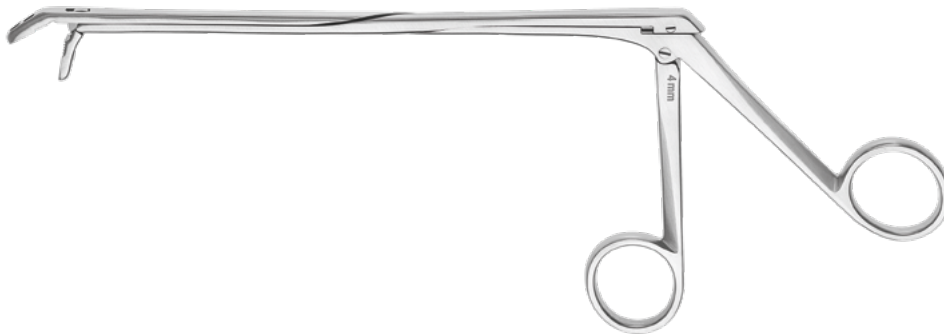

2x12mm bite	
140mm, 5 ¹ / ₂ "	250-130-142
160mm, 6 ¹ / ₄ "	250-130-162
180mm, 7"	250-130-182

3x12mm bite	
140mm, 5 ¹ / ₂ "	250-130-143
160mm, 6 ¹ / ₄ "	250-130-163
180mm, 7"	250-130-183



2x12mm bite	
140mm, 5 ¹ / ₂ "	250-140-142
160mm, 6 ¹ / ₄ "	250-140-162
180mm, 7"	250-140-182

3x12mm bite	
140mm, 5 ¹ / ₂ "	250-140-143
160mm, 6 ¹ / ₄ "	250-140-163
180mm, 7"	250-140-183



2x12mm bite	
140mm, 5 ¹ / ₂ "	250-150-142
160mm, 6 ¹ / ₄ "	250-150-162
180mm, 7"	250-150-182

3x12mm bite	
140mm, 5 ¹ / ₂ "	250-150-143
160mm, 6 ¹ / ₄ "	250-150-163
180mm, 7"	250-150-183

straight, 4x14mm bite	
140mm, 5 ¹ / ₂ "	250-130-144
160mm, 6 ¹ / ₄ "	250-130-164
180mm, 7"	250-130-184

straight, 5x14mm bite	
140mm, 5 ¹ / ₂ "	250-130-145
160mm, 6 ¹ / ₄ "	250-130-165
180mm, 7"	250-130-185

straight, 6x16mm bite	
140mm, 5 ¹ / ₂ "	250-130-146
160mm, 6 ¹ / ₄ "	250-130-166
180mm, 7"	250-130-186

upwards curved, 4x14mm bite	
140mm, 5 ¹ / ₂ "	250-140-144
160mm, 6 ¹ / ₄ "	250-140-164
180mm, 7"	250-140-184

upwards curved, 5x14mm bite	
140mm, 5 ¹ / ₂ "	250-140-145
160mm, 6 ¹ / ₄ "	250-140-165
180mm, 7"	250-140-185

upwards curved, 6x16mm bite	
140mm, 5 ¹ / ₂ "	250-140-146
160mm, 6 ¹ / ₄ "	250-140-166
180mm, 7"	250-140-186

downwards curved, 4x14mm bite	
140mm, 5 ¹ / ₂ "	250-150-144
160mm, 6 ¹ / ₄ "	250-150-164
180mm, 7"	250-150-184

downwards curved, 5x14mm bite	
140mm, 5 ¹ / ₂ "	250-150-145
160mm, 6 ¹ / ₄ "	250-150-165
180mm, 7"	250-150-185

downwards curved, 6x16mm bite	
140mm, 5 ¹ / ₂ "	250-150-146
160mm, 6 ¹ / ₄ "	250-150-166
180mm, 7"	250-150-186

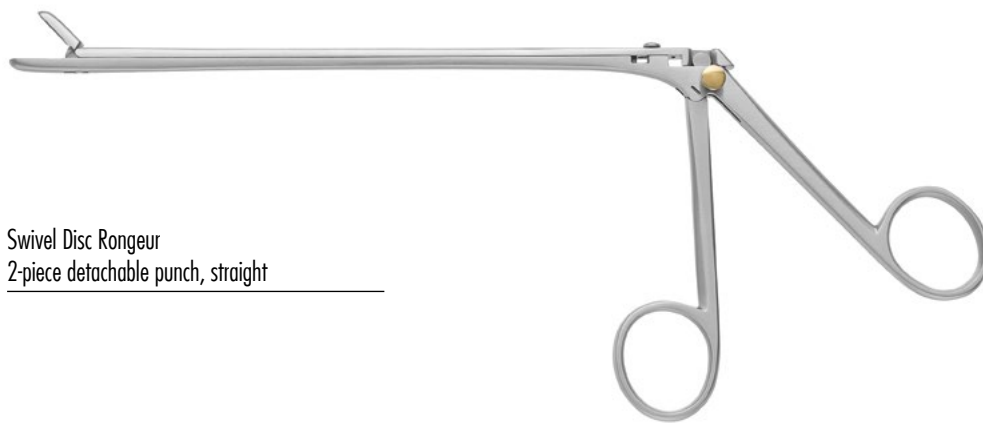

Swivel Disc Rongeur
 2-piece detachable punch, straight



CUSHING

2x10mm

length	straight jaw	30° upwards jaw	30° downwards jaw
150mm, 6"	250-700-152	250-710-152	250-720-152
180mm, 7"	250-700-182	250-710-182	250-720-182
200mm, 8"	250-700-202	250-710-202	250-720-202

LOVE GRUENWALD

3x10mm

length	straight jaw	30° upwards jaw	30° downwards jaw
150mm, 6"	250-700-153	250-710-153	250-720-153
180mm, 7"	250-700-183	250-710-183	250-720-183
200mm, 8"	250-700-203	250-710-203	250-720-202

SPURLING

4x10mm

length	straight jaw	30° upwards jaw	30° downwards jaw
150mm, 6"	250-700-154	250-710-154	250-720-154
180mm, 7"	250-700-184	250-710-184	250-720-184
200mm, 8"	250-700-204	250-710-204	250-720-204

CASPAR

5x10mm

length	straight jaw	30° upwards jaw	30° downwards jaw
150mm, 6"	250-700-155	250-710-155	250-720-155
180mm, 7"	250-700-185	250-710-185	250-720-185
200mm, 8"	250-700-205	250-710-205	250-720-205

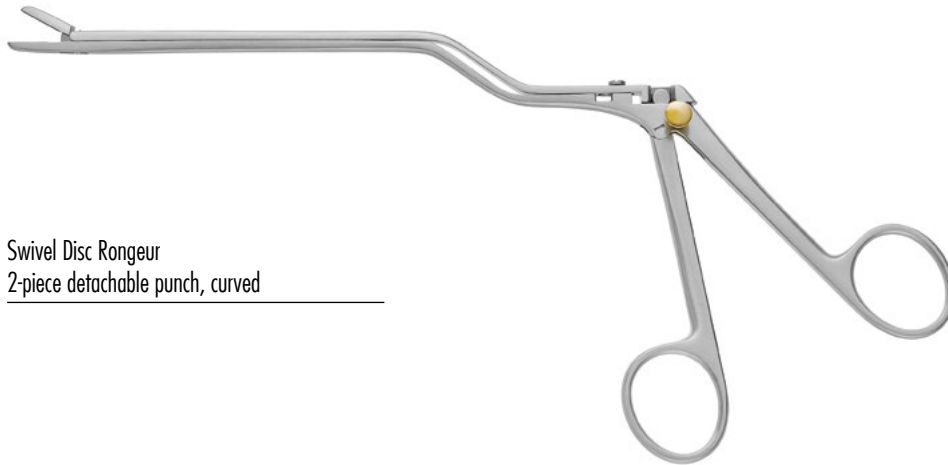

Swivel Disc Rongeur
 2-piece detachable punch, curved



CUSHING

2x10mm

length	bayonet right, straight jaw	bayonet left, straight jaw	bayonet up, straight jaw
110mm, 4 ¹ / ₃ "	250-750-112	250-760-112	250-770-112
150mm, 6"	250-750-152	250-760-152	250-770-152
180mm, 7"	250-750-182	250-760-182	250-770-182

LOVE GRUENWALD

3x10mm

length	bayonet right, straight jaw	bayonet left, straight jaw	bayonet up, straight jaw
110mm, 4 ¹ / ₃ "	250-750-113	250-760-113	250-770-113
150mm, 6"	250-750-153	250-760-153	250-770-153
180mm, 7"	250-750-183	250-760-183	250-770-182

SPURLING

4x10mm

length	bayonet right, straight jaw	bayonet left, straight jaw	bayonet up, straight jaw
110mm, 4 ¹ / ₃ "	250-750-114	250-760-114	250-770-114
150mm, 6"	250-750-154	250-760-154	250-770-154
180mm, 7"	250-750-184	250-760-184	250-770-184

CASPAR

5x10mm

length	bayonet right, straight jaw	bayonet left, straight jaw	bayonet up, straight jaw
110mm, 4 ¹ / ₃ "	250-750-115	250-760-115	250-770-115
150mm, 6"	250-750-155	250-760-155	250-770-155
180mm, 7"	250-750-185	250-760-185	250-770-185

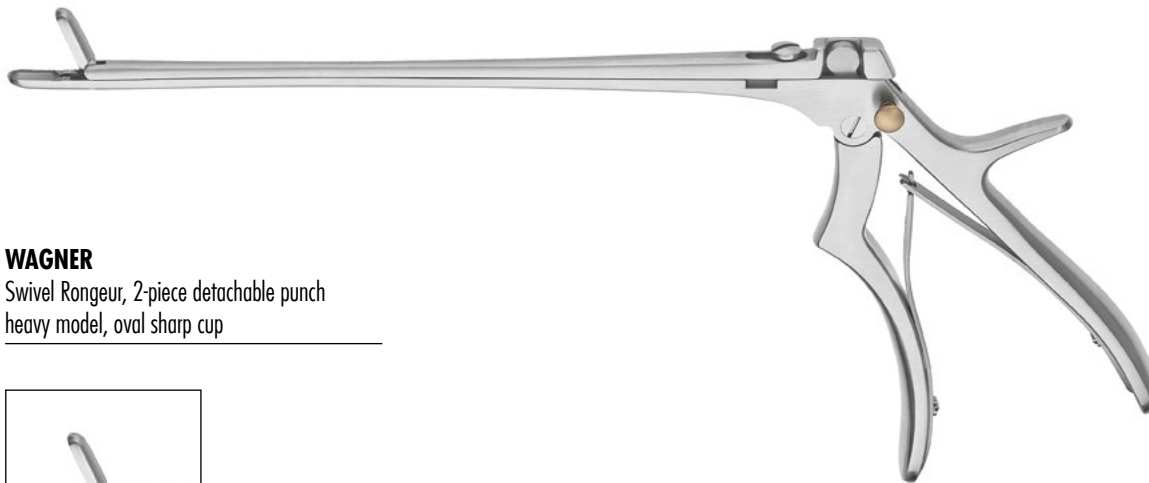
WAGNER

Swivel Rongeur, 2-piece detachable punch heavy model, oval sharp cup

 straight
 bite

	200mm, 8"	300mm, 11 ⁷ / ₈ "
3mm	250-670-203	250-670-303
4mm	250-670-204	250-670-304
5mm	250-670-205	250-670-305

 50° upwards
 bite

	200mm, 8"	300mm, 11 ⁷ / ₈ "
4mm	250-671-204	250-671-304

 bayonet shape, straight jaw
 bite

	110mm, 4 ¹ / ₃ "	150mm, 6"	180mm, 7"
3mm	250-672-113	250-672-153	250-672-183
4mm	250-672-114	250-672-154	250-672-184
5mm	250-672-115	250-672-155	250-672-185

 bayonet shape, 50° upwards
 bite

	110mm, 4 ¹ / ₃ "	150mm, 6"	180mm, 7"
3mm	250-673-113	250-673-153 (30°)	250-673-183
4mm	250-673-114	250-673-154	250-673-184
5mm	250-673-115	250-673-155	250-673-185

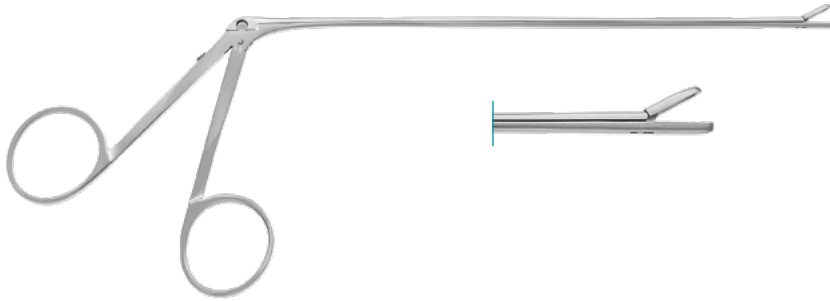

DECKER

Rongeur, fine model, 2x6mm jaw
150mm, 6"

straight	250-066-817
left curved	250-066-824
right curved	250-066-827

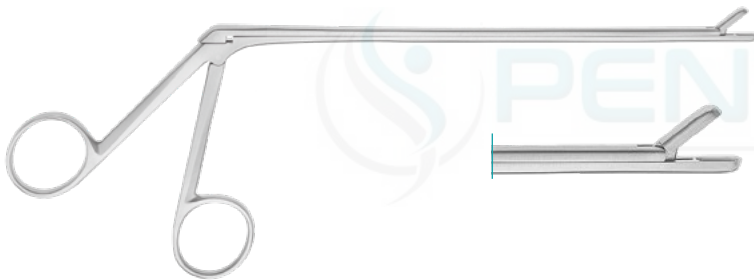

DECKER

Rongeur, 2x6mm jaw, straight

150mm, 6"	250-067-817
-----------	-------------

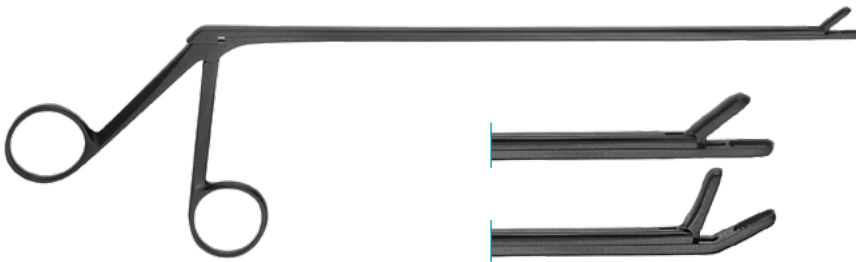

Micro Rongeur, CERA-CUT®
2mm jaw, 170mm, 6²/₃"

straight	250-300-170CC
upcurved	250-301-170CC

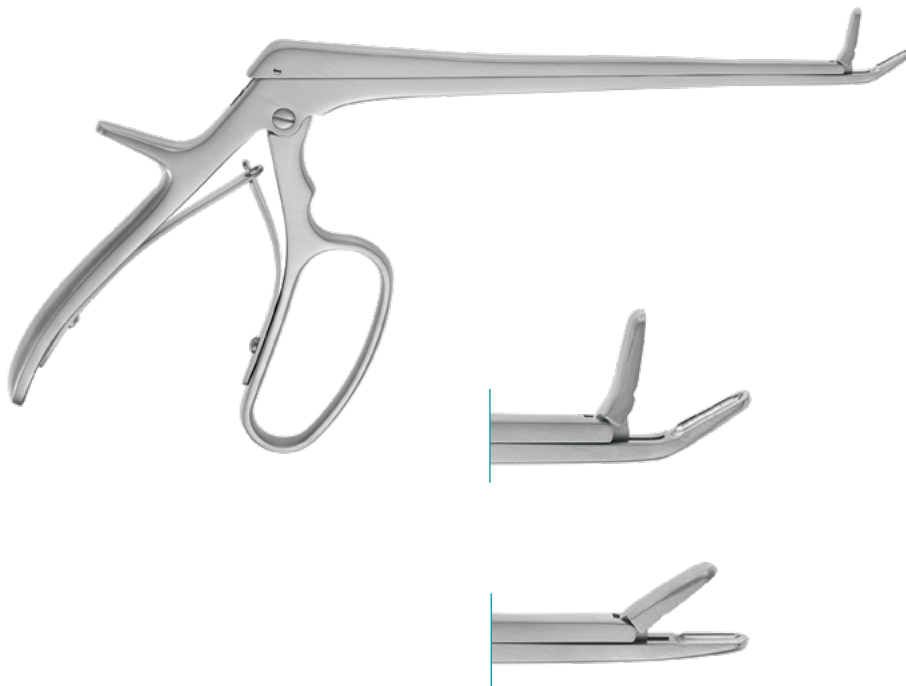
FERRIS SMITH

 Disc Rongeur, straight
 180mm, 7"

2mm	250-067-802
3mm	250-067-803
4mm	250-067-804
6mm	250-067-806

200mm, 8"

2mm	250-068-802
3mm	250-068-803
4mm	250-068-804
6mm	250-068-806

 upwards angled
 180mm, 7"

2mm	250-067-782
3mm	250-067-783
4mm	250-067-784
6mm	250-067-786

200mm, 8"

2mm	250-067-765
3mm	250-067-766
4mm	250-067-767
6mm	250-067-768

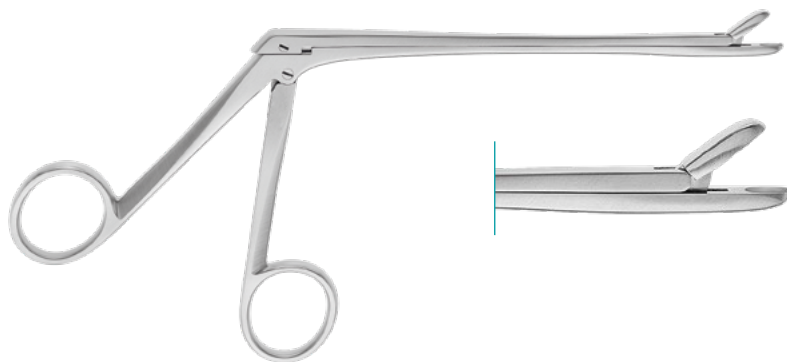

PEAPOD

 Rongeur, 140mm, 5^{1/2}"
 straight

2 x 6mm bite	250-115-140
2.5 x 7mm bite	250-118-140
3 x 10mm bite	250-116-140

upwards angled

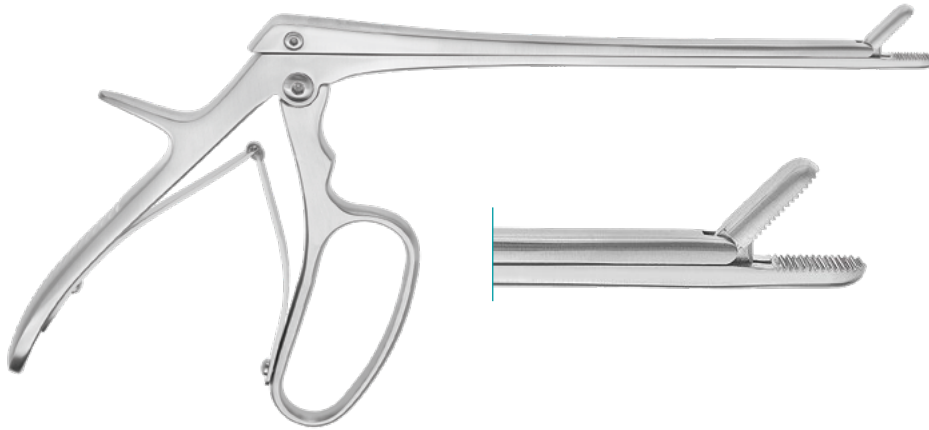
2 x 6mm bite	250-114-140
2.5 x 7mm bite	250-119-140
3 x 10mm bite	250-117-140



CLOWARD

Rongeur, straight jaw, serrated
180mm, 7"

4mm	250-066-796
-----	-------------

6mm	250-066-797
-----	-------------

200mm, 8"	
-----------	--

4mm	250-066-786
-----	-------------

6mm	250-066-787
-----	-------------

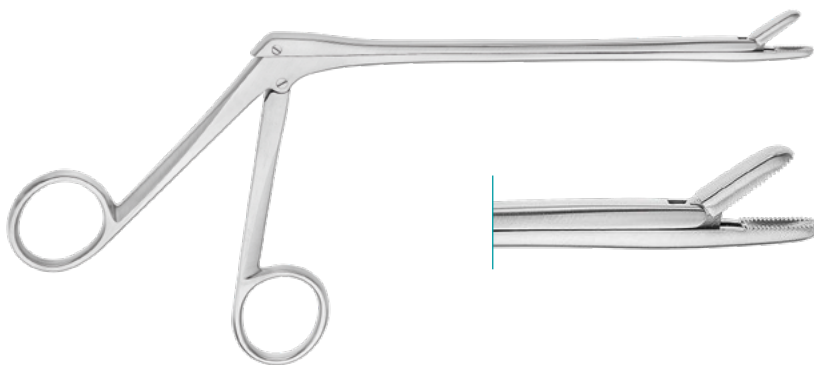

SCHLESINGER

Rongeur, straight jaw, fine serrated
150mm, 6"

2mm	259-195-002
-----	-------------

3mm	259-195-003
-----	-------------

4mm	259-195-004
-----	-------------

180mm, 7"	
-----------	--

2mm	259-196-002
-----	-------------

3mm	259-196-003
-----	-------------

4mm	259-196-004
-----	-------------

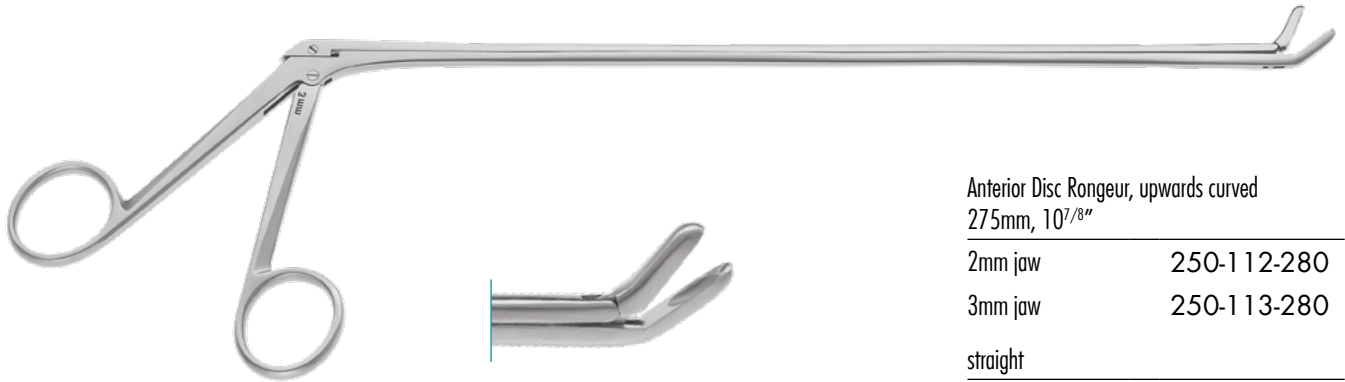

Anterior Disc Rongeur, upwards curved
275mm, 10⁷/₈"

2mm jaw 250-112-280

3mm jaw 250-113-280

straight

2mm jaw 250-102-280

3mm jaw 250-103-280

4mm jaw 250-104-280

5mm jaw 250-105-280



VILBISS

Cranial Rongeur Forceps
with replacement blade

210mm, 8¹/₄" 250-066-798

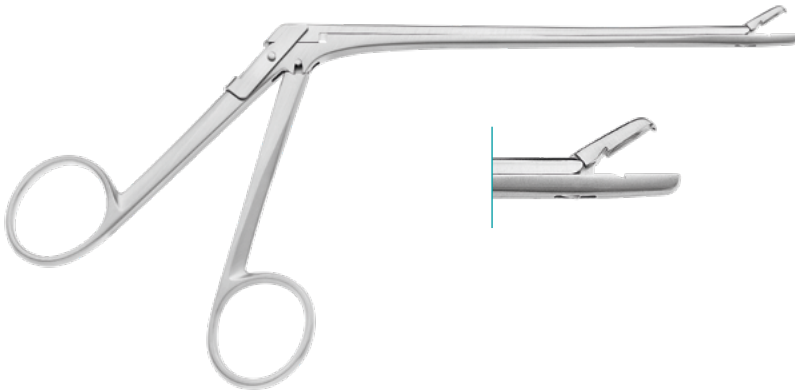

WILLIAMS

Dissectomy Rongeur, 2.3mm wide cup,
1.0mm single teeth

140mm, 5 ¹ / ₂ "	250-068-140
230mm, 9"	250-068-230

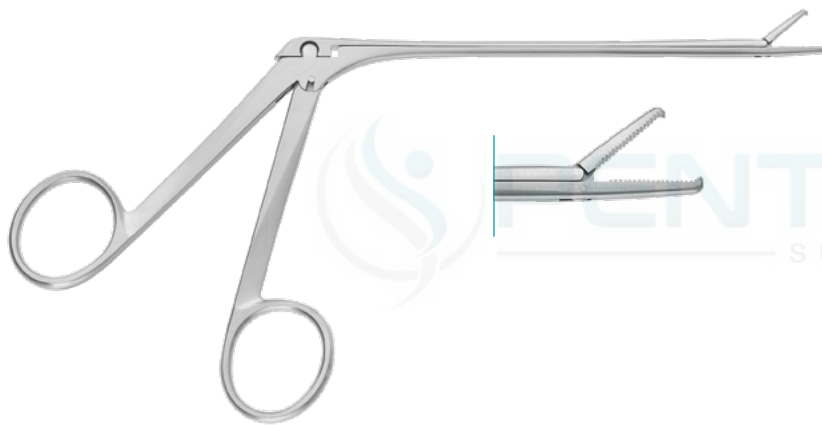

NOYES

Alligator Forceps, 1x2 teeth with serrated jaw

140mm, 5 ¹ / ₂ "	250-526-140
--	-------------

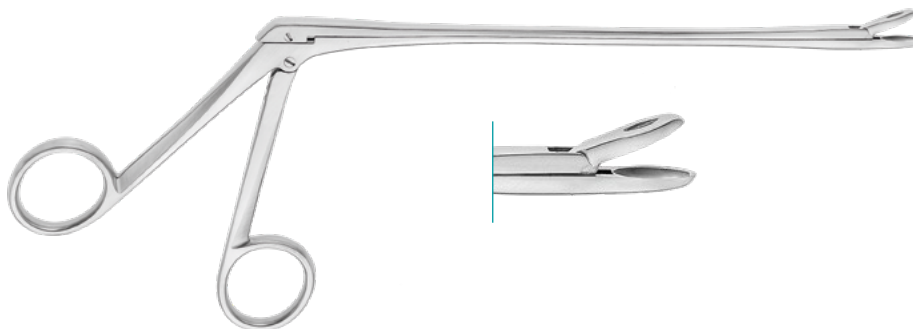

WEIL BLAKESLEY

Rongeur, fenestrated jaw, fine serrated
180mm, 7", straight

3.0mm	252-030-180
3.5mm	252-035-180
4.0mm	252-040-180
upwards angled	
3.0mm	252-030-181
3.5mm	252-035-181
4.0mm	252-040-181

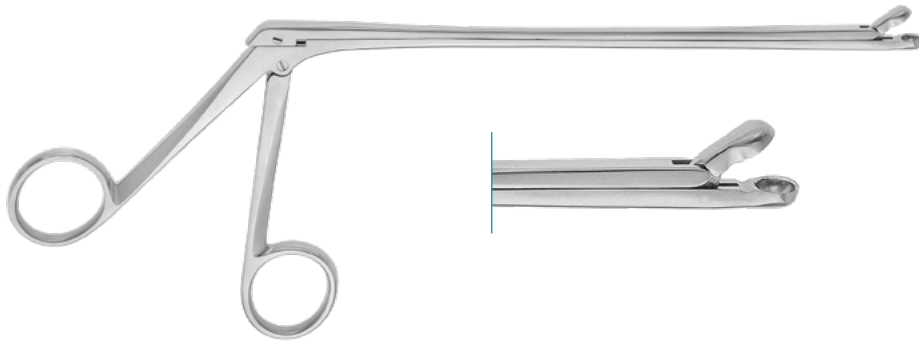

OLDBERG

Rongeur, Ø7mm

180mm, 7"

250-066-605

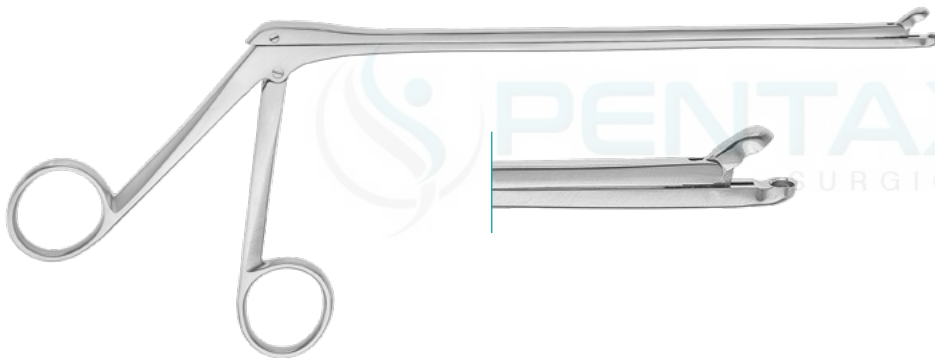

YASARGIL

Rongeur, 190mm, 7¹/₂"

Ø2.2mm

250-066-599

Ø3.5mm

250-066-600

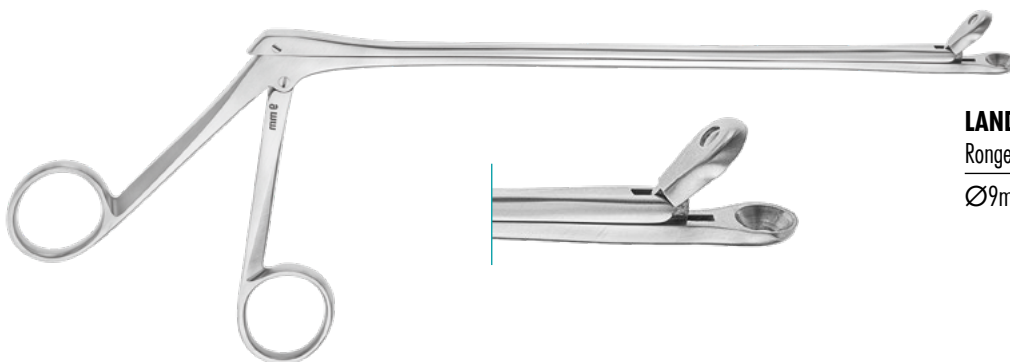

LANDOLT

Rongeur, 200mm, 8"

Ø9mm

250-066-345



Micro Dissectomy Rongeur,
black coated, 180mm, 7"

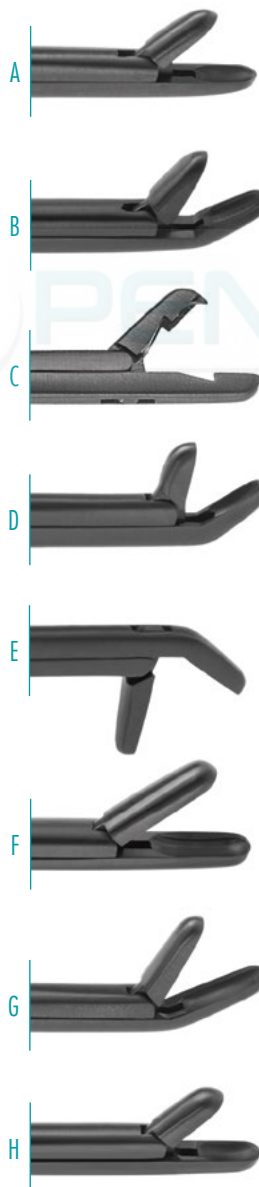

A	straight, 2x6mm	250-000-016
B	30° bent up, 2x6mm	250-000-017
C	Grasper, 2mm	250-000-018
D	40° upwards curved, 2x6mm	250-000-019
E	downwards curved, 2x6mm	250-000-020
F	straight, 4mm	250-000-021
G	upwards angled, 4mm	250-000-022
H	short straight, Kerrison handle 4mm	250-000-023

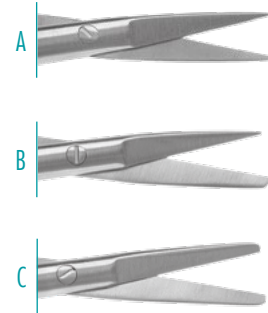
Micro Scissors, straight
A sharp/sharp, 70mm working length

 190mm, 7¹/₂" 250-800-190

90mm working length

 210mm, 8¹/₄" 250-800-210

120mm working length

 240mm, 9¹/₂" 250-800-240

135mm working length

255mm, 10" 250-800-255

B sharp/blunt, 70mm working length

 190mm, 7¹/₂" 250-802-190

90mm working length

 210mm, 8¹/₄" 250-802-210

120mm working length

 240mm, 9¹/₂" 250-802-240

C blunt/blunt, 70mm working length

 190mm, 7¹/₂" 250-804-190

90mm working length

 210mm, 8¹/₄" 250-804-210

120mm working length

 240mm, 9¹/₂" 250-804-240

135mm working length

255mm, 10" 250-804-255

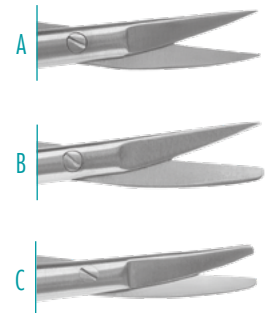
Micro Scissors, curved
A sharp/sharp, 70mm working length

 190mm, 7¹/₂" 250-801-190

90mm working length

 210mm, 8¹/₄" 250-801-210

120mm working length

 240mm, 9¹/₂" 250-801-240

135mm working length

255mm, 10" 250-801-255

B sharp/blunt, 70mm working length

 190mm, 7¹/₂" 250-803-190

90mm working length

 210mm, 8¹/₄" 250-803-210

120mm working length

 240mm, 9¹/₂" 250-803-240

C blunt/blunt, 70mm working length

 190mm, 7¹/₂" 250-805-190

90mm working length

 210mm, 8¹/₄" 250-805-210

120mm working length

 240mm, 9¹/₂" 250-805-240

135mm working length

255mm, 10" 250-805-255

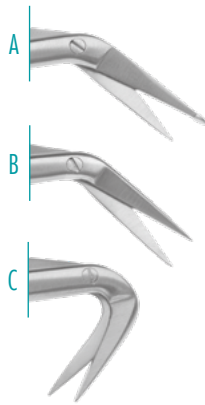

Micro Scissors, angled
90mm working length

A knob/sharp, 45° angled
210mm, 8¹/₄" 250-811-210

B sharp/sharp, 45° angled
210mm, 8¹/₄" 250-813-210

C sharp/sharp, 125° angled
210mm, 8¹/₄" 250-815-210

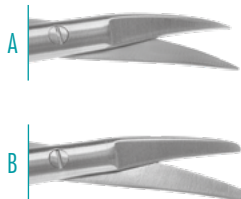

Micro Scissors, downward curved
90mm working length

A sharp/sharp
210mm, 8¹/₄" 250-807-210

B blunt/blunt
210mm, 8¹/₄" 250-809-210

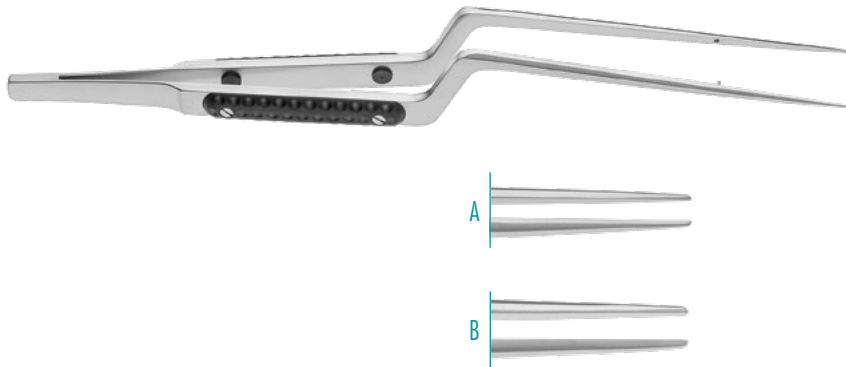

Micro Forceps

A 0.5mm jaw

190mm, 7 ¹ / ₂ "	250-820-190
210mm, 8 ¹ / ₄ "	250-820-210
240mm, 9 ¹ / ₂ "	250-820-240

Neuro Forceps

B 0.9mm jaw

190mm, 7 ¹ / ₂ "	250-822-190
210mm, 8 ¹ / ₄ "	250-822-210
240mm, 9 ¹ / ₂ "	250-822-240

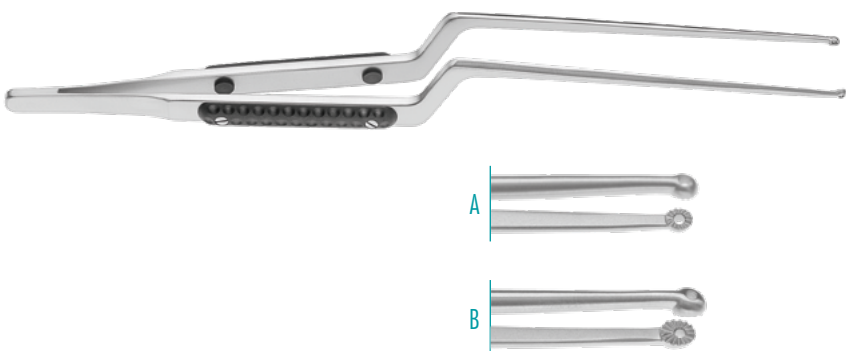

Micro Tumor Grasping Forceps

A Ø 2.5mm

210mm, 8 ¹ / ₄ "	250-830-210
245mm, 9 ² / ₃ "	250-830-245

B Ø 3.5mm

210mm, 8 ¹ / ₄ "	250-832-210
245mm, 9 ² / ₃ "	250-832-245

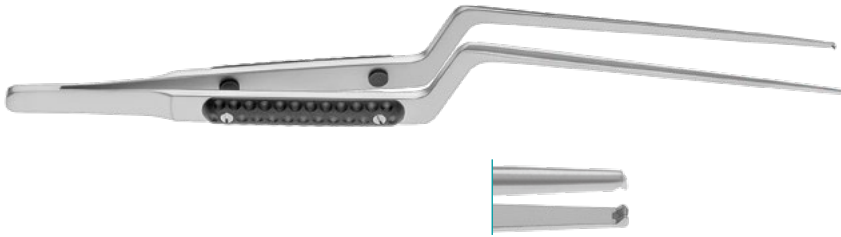

Micro Tissue Forceps

1x2 teeth

210mm, 8^{1/4}"

250-850-210



Micro Needle Holder,

curved, 0.5mm jaw,

70mm working length

200mm, 8"

250-841-200

90mm working length

220mm, 8^{2/3}"

250-841-220

120mm working length

250mm, 9^{7/8}"

250-841-250



Container, double layer system

265 x 255 x 65mm

600-407-255

400 x 290 x 75mm

600-407-260

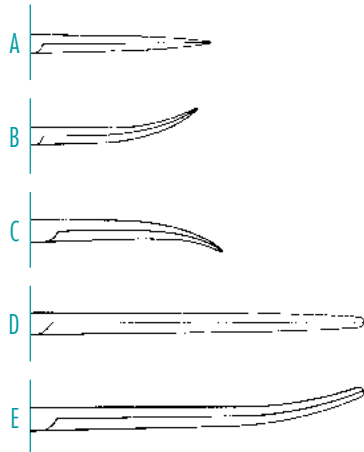
YASARGIL
A Micro Scissors, straight

 165mm, 6^{1/2}" 250-064-030

200mm, 8" 250-064-034

B curved

 165mm, 6^{1/2}" 250-064-031

200mm, 8" 250-064-035

C curved downwards

200mm, 8" 250-064-036

D straight, dissecting

200mm, 8" 250-064-032

E curved, dissecting

200mm, 8" 250-064-033

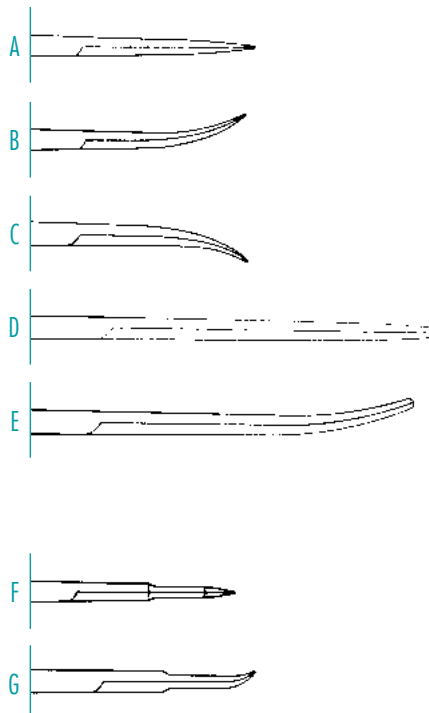
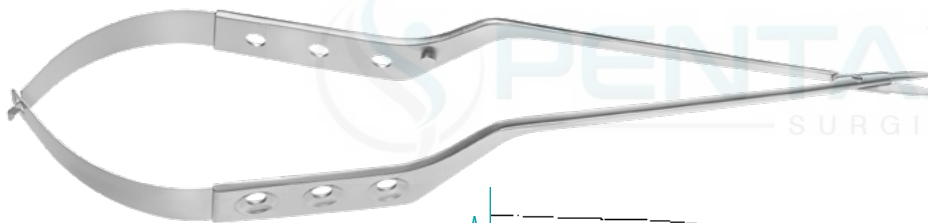
YASARGIL
A Micro Scissors, straight

 225mm, 8^{7/8}" 250-064-038

toothed blades 250-064-060

B curved

 225mm, 8^{7/8}" 250-064-039

 245mm, 9^{2/3}" 250-064-061

C curved downwards

 225mm, 8^{7/8}" 250-064-047

D Dissecting Scissors, straight

 225mm, 8^{7/8}" 250-064-044

E Dissecting Scissors, curved

 225mm, 8^{7/8}" 250-064-043

VANNAS

 Micro Scissors, straight, 225mm, 8^{7/8}"

F straight 250-064-037

G curved 250-064-040

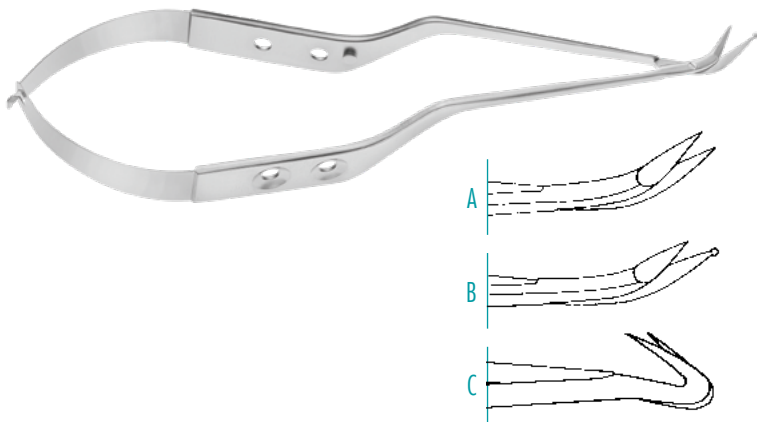

NAGEL
A Micro Scissors, 45°

200mm, 8" 250-064-056

B 45°, with probe-pointed blade

200mm, 8" 250-064-057

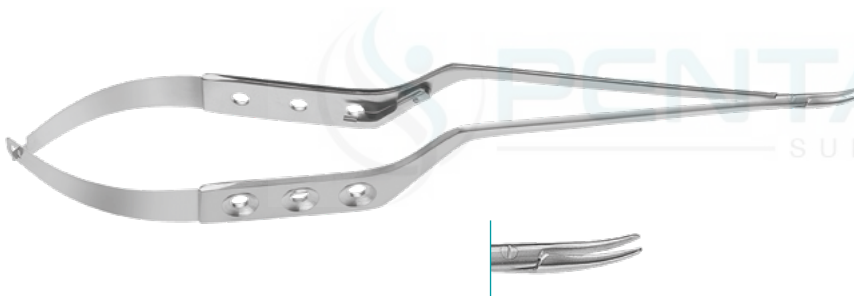
C 125°

 190mm, 7^{1/2}" 250-064-059

YASARGIL

Micro Needle Holder, straight

 165mm, 6^{1/2}" 250-064-089

200mm, 8" 250-064-092

 225mm, 8^{7/8}" 250-064-096

curved

 165mm, 6^{1/2}" 250-064-089

200mm, 8" 250-064-093

 225mm, 8^{7/8}" 250-064-097

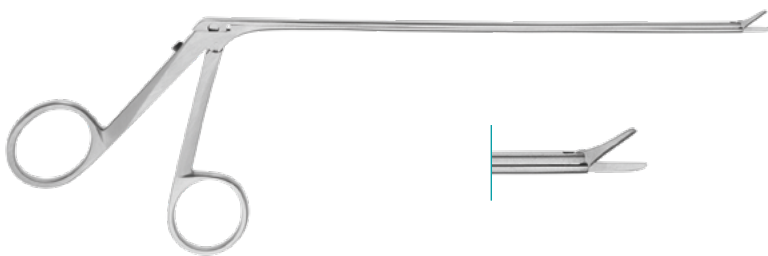
 245mm, 9^{2/3}" 250-064-099

DECKER

Micro Scissors, fine model, 5mm

150mm, 6"

straight 250-066-601

left curved 250-066-602

right curved 250-066-603



Micro Instruments with Luer-Lock
160mm, 6^{1/4}" working length



A FAHLBUSCH
Micro Scissors

250-064-223



B NICOLA
Micro Forceps, Ø 2.5mm

250-064-222



C YASARGIL NICOLA
Micro Grasping Forceps, 1mm conical jaw

250-064-224



D NICOLA
Micro Scissors, straight

250-064-226

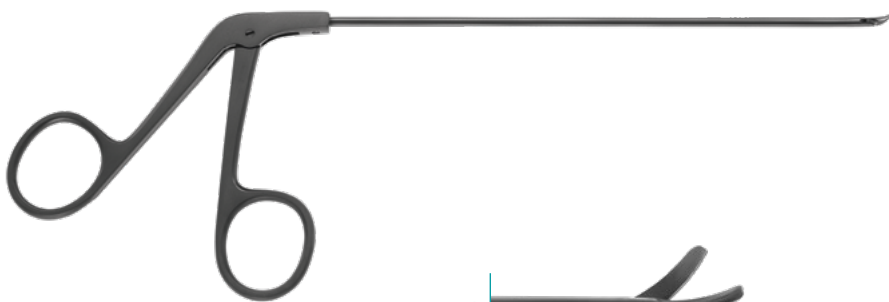

Micro Spinal Scissors
150mm, 6" working length, black coated,
2mm, curved



A blunt 250-000-033



B sharp 250-000-034



Titanium Micro Needle Holder, straight, with box catch, 1mm diamond dusted jaw, 8mm round handle

210mm, 8¹/₄" 250-218-210

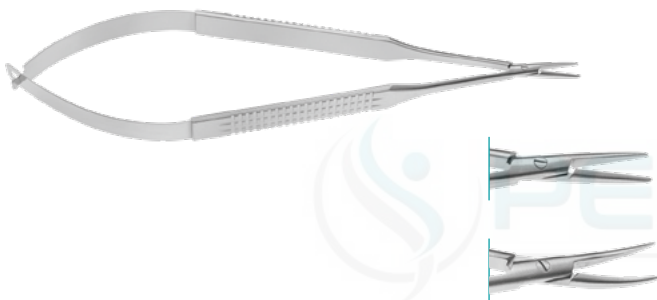

Micro Needle Holder, without catch, 160mm, 6¹/₄" working length

straight 250-069-076

curved 250-069-079

180mm, 7" working length

straight 250-069-080

curved 250-069-081



Micro Needle Holder, diamond dusted without catch, 160mm, 6¹/₄" working length

straight 250-269-076

curved 250-269-079

180mm, 7" working length

straight 250-269-080

curved 250-269-081

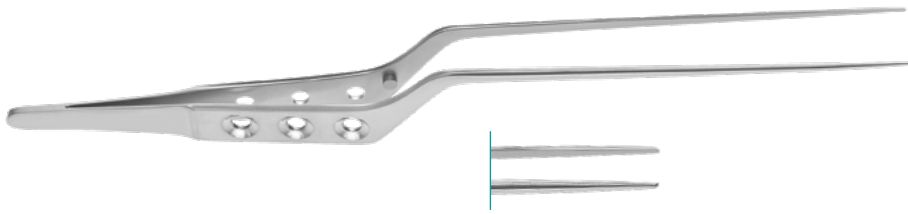
YASARGIL

Micro Forceps, 0.6mm tip

160mm, 6 ¹ / ₄ "	250-024-830
180mm, 7"	250-024-835
200mm, 8"	250-024-840
220mm, 8 ² / ₃ "	250-024-845
240mm, 9 ¹ / ₂ "	250-024-850

0.9mm tip

160mm, 6 ¹ / ₄ "	250-024-831
180mm, 7"	250-024-836
200mm, 8"	250-024-841
220mm, 8 ² / ₃ "	250-024-846
240mm, 9 ¹ / ₂ "	250-024-851

1x2 teeth

180mm, 7"	250-024-837
-----------	-------------

YASARGIL

A Micro Grasping Forceps Ø 3mm

220mm, 8 ² / ₃ "	250-064-210
--	-------------

B Ø 5mm

220mm, 8 ² / ₃ "	250-064-212
--	-------------

C Ø 3mm, flat jaw, serrated

220mm, 8 ² / ₃ "	250-064-214
--	-------------

D Ø 5mm, flat jaw, serrated

220mm, 8 ² / ₃ "	250-064-216
--	-------------

YASARGIL SAMII

E Ø 3mm, spoon-shaped

240mm, 9 ¹ / ₂ "	250-064-200
--	-------------

F Ø 5mm, spoon-shaped

240mm, 9 ¹ / ₂ "	250-064-202
--	-------------

G Ø 7mm, spoon-shaped

240mm, 9 ¹ / ₂ "	250-064-204
--	-------------

HEIFETZ

H Ø 3mm, curette jaw, toothed

220mm, 8 ² / ₃ "	250-064-215
--	-------------

I Ø 5mm, curette jaw, toothed

220mm, 8 ² / ₃ "	250-064-217
--	-------------



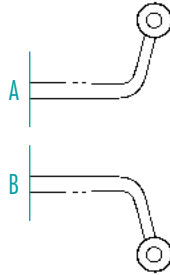
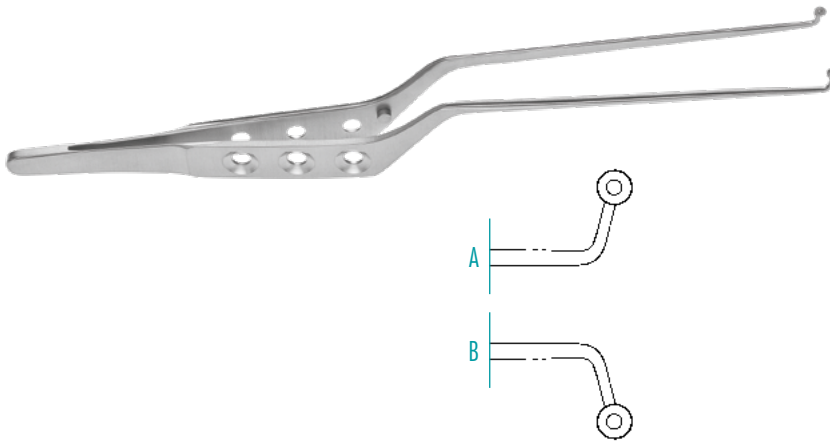

SAMI

A Micro Grasping Forceps, 230mm, 9" left angled

Ø 3mm	250-064-190
Ø 4mm	250-064-191
Ø 5mm	250-064-192

B right angled

Ø 3mm	250-064-195
Ø 4mm	250-064-196
Ø 5mm	250-064-197

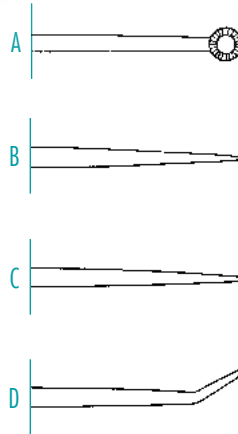

HUNT

A Tumor Tissue Forceps, Ø 5mm flat jaw, serrated, straight

200mm, 8"	250-024-766
-----------	-------------

B fine tip

185mm, 7 ¹ / ₄ "	250-064-110
--	-------------

C broad tip

185mm, 7 ¹ / ₄ "	250-064-111
--	-------------

D broad tip, angled

185mm, 7 ¹ / ₄ "	250-064-112
--	-------------



HUNT

Tumor Tissue Forceps, Ø 5mm serrated jaw

200mm, 8"	250-024-765
-----------	-------------

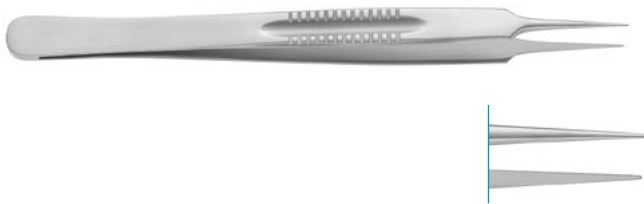

LAZAR

Micro Suture Tying Forceps
155mm, 6^{1/8}"

0.5mm tip	250-024-260
0.8mm tip	250-024-261

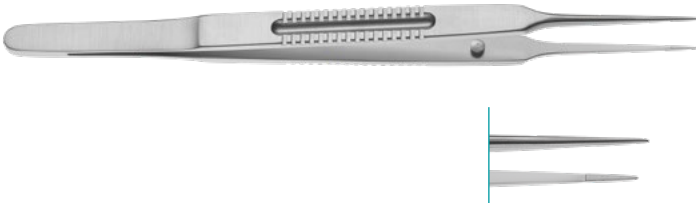

Micro Suture Tying Forceps
185mm, 7^{1/4}"

0.5mm tip	250-024-264
-----------	-------------



VISE

Micro Suture Tying Forceps
A straight, 0.3mm tip

120mm, 4 ^{3/4} "	250-024-338
135mm, 5 ^{1/3} "	250-024-336

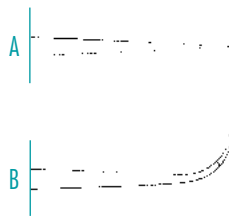

B curved, 0.3mm tip

135mm, 5 ^{1/3} "	250-024-337
---------------------------	-------------



AUSTIN

Micro Suture Tying Forceps,
0.8mm tip

140mm, 5 ^{1/2} "	250-024-340
180mm, 7"	250-024-342

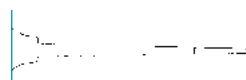

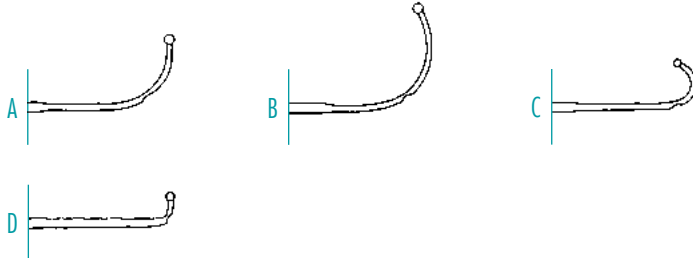

YASARGIL

Ligature Guide, 185mm, 7¹/₄"

A	250-064-270
B	250-064-271
C	250-064-272
D	250-064-273

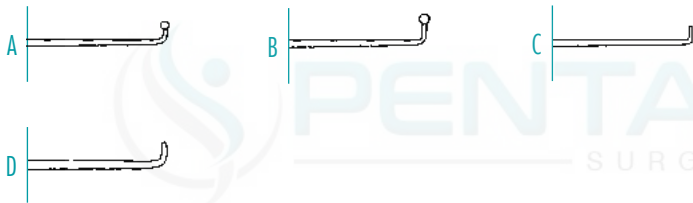

KRAYENBÜHL

Nerve / Vessel Hook, 185mm, 7¹/₄"

A	250-064-396
B	250-064-397
C	250-064-398
D	250-064-399

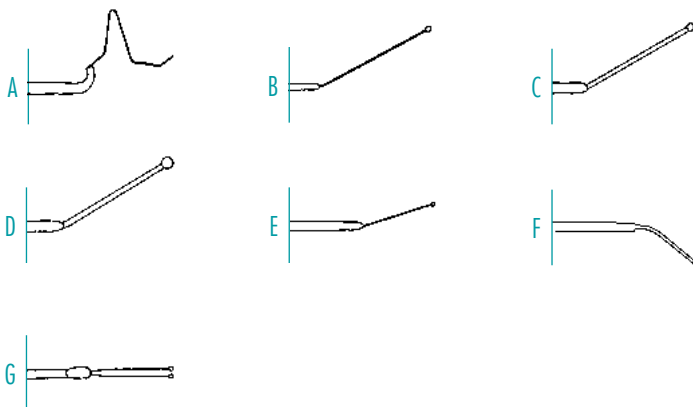

BIEMER

A Vessel Spreader,

160mm, 6¹/₄" 250-064-310

Vessel Dilator, 125mm, 5"

B Ø 0.5mm	250-064-306
C Ø 1.0mm	250-064-307
D Ø 1.5mm	250-064-308

JACOBSON

Vessel Probe, 185mm, 7¹/₄"

E	250-064-311
F	250-064-313
G	250-064-312

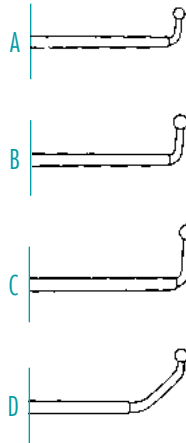

CASPAR

 Exploration / Coagulation Hook,
 245mm, 9²/₃" , insulated

A	250-020-088
B	250-020-089
C	250-020-090
D	250-020-091

non-insulated

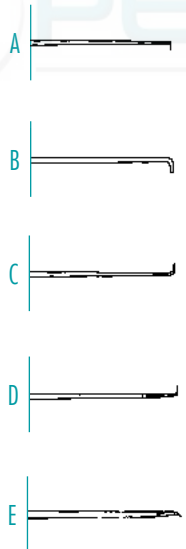
A	250-010-088
B	250-010-089
C	250-010-090
D	250-010-091



Micro Hook, 90°, 230mm, 9"

A sharp	250-064-330
B blunt	250-064-331

FISCH

 90°, sharp , 185mm, 7¹/₄"

C curved	250-064-375
D angled	250-064-376

JACOBSON

 Micro Vessel Knife, 185mm, 7¹/₄"

E	250-064-350
---	-------------



Tissue Pick, Ø 1.8mm

185mm, 7 ¹ / ₄ "	250-064-392
--	-------------



FRAZIER

Dura Hook, sharp

130mm, 5¹/₈"

170-013-130



O'CONNOR

Nerve Hook, sharp

120mm, 4³/₄"

170-040-160



DANDY

Nerve Hook, 3mm, 200mm, 8"

straight 250-746-000

right curved 250-746-001

left curved 250-746-002



COTTLE

Nerve Hook, 168mm, 6²/₃"

180° retrograde curved	230-286-160
120° retrograde curved	230-285-160



SACHS

Dura Hook

185mm, 7 ¹ / ₄ "	250-403-185
--	-------------



SMITHWICK

Nerve Hook

170mm, 6 ² / ₃ "	250-507-170
--	-------------



GRAHAM

Dura Hook

165mm, 6¹/₂" 250-405-160



CUSHING

Nerve Hook, 190mm, 7¹/₂"

small 170-060-001

large 170-060-002



ADSON

Dura Hook, 200mm, 8"

blunt 250-407-200

sharp 250-409-200



WEARY

Nerve Hook, fine, blunt, black coated

200mm, 8" 250-408-200

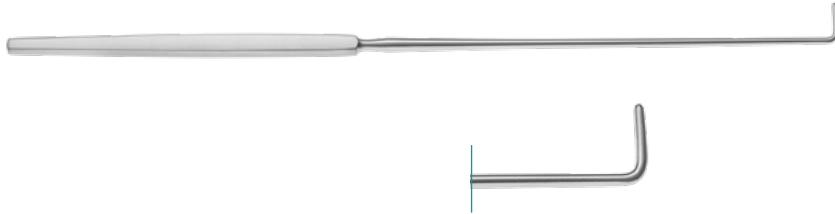

HOEN

Hook, 90°

220mm, 8²/₃"

250-747-220



CUSHING

Nerve Hook, 280mm, 11"

small

250-742-280

large

250-743-280

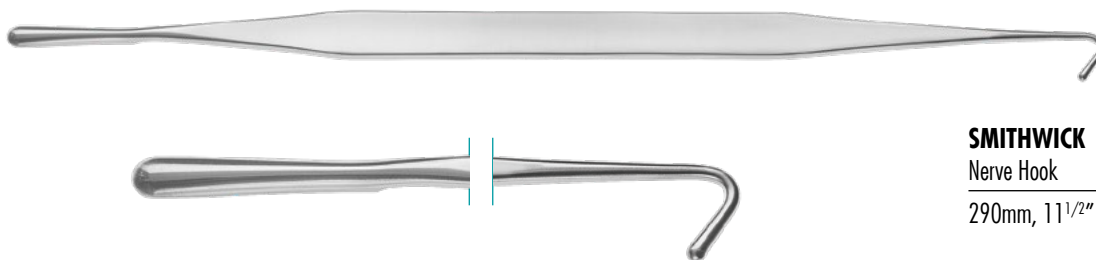

SMITHWICK

Nerve Hook

290mm, 11¹/₂"

250-507-290

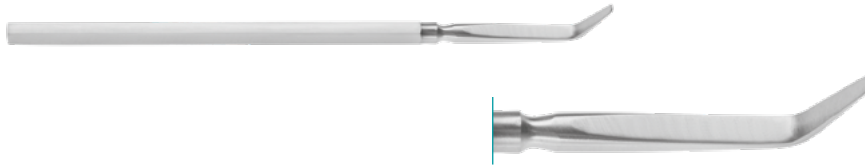

FRAZIER

Elevator

160mm, 6¹/₄"

250-746-150

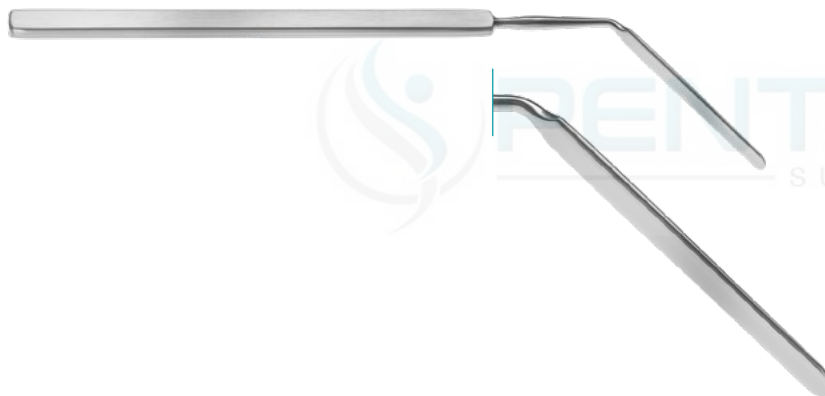

HORSLEY

Dissector, angled

200mm, 8"

250-750-200



HOEN

Elevator, 150mm, 6"

45°

250-747-150

90°

250-747-153



SACHS

Dissector, sharp

210mm, 8^{1/4}"

250-687-210



DAVIS

Dissector

195mm, 7^{3/4}"

250-696-195



OLIVECRONA

Dissector, double-ended

4 x 5mm, heavy pattern

180mm, 7"

250-694-180

240mm, 9^{1/2}"

250-694-240



OLIVECRONA

Dissector, double-ended, fenestrated tip,

2 x 3mm

180mm, 7"

250-696-180

240mm, 9^{1/2}"

250-696-240

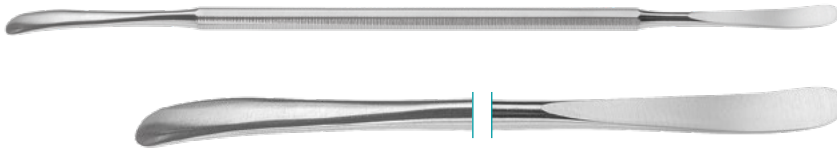

Dissector, double ended

220mm, 8²/₃"

290-500-220

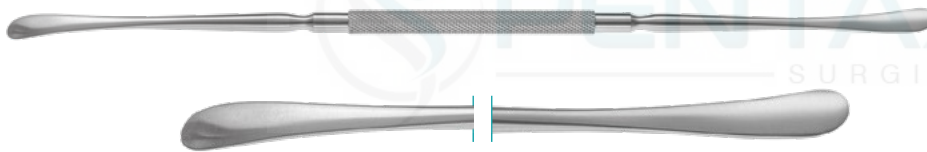

DAVIS

Vascular Dissector, double ended

245mm, 9²/₃"

290-300-245

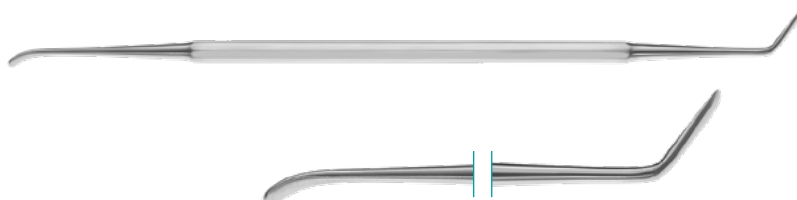

MILLIGAN

Dura Dissector, double ended

210mm, 8¹/₄"

250-685-210

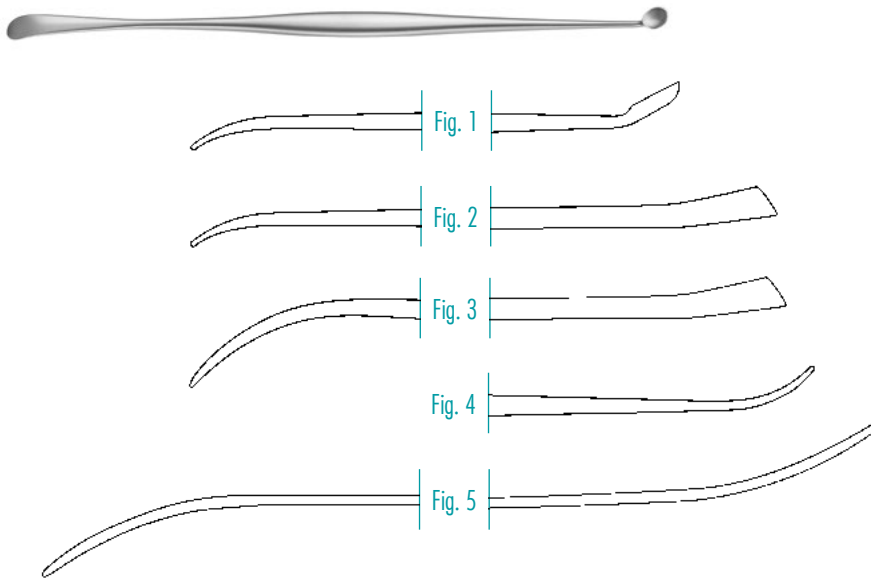
PENFIELD

Dissector

Fig. 1	175mm, 6 ⁷ / ₈ "	250-691-175
Fig. 2	195mm, 7 ³ / ₄ "	250-692-195
Fig. 3	195mm, 7 ³ / ₄ "	250-693-195
Fig. 4	215mm, 8 ¹ / ₂ "	250-694-215
Fig. 5	290mm, 11 ¹ / ₂ "	250-695-290

TOENNIS

Dissector, blunt/blunt

Fig. 1	3+4mm	250-301-240
Fig. 2	5+6mm	250-302-240

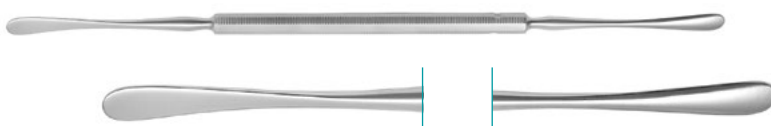
FREER

Septum Elevator, sharp/blunt, 200mm, 8"

4.5mm	420-545-001
6.5mm	420-545-002

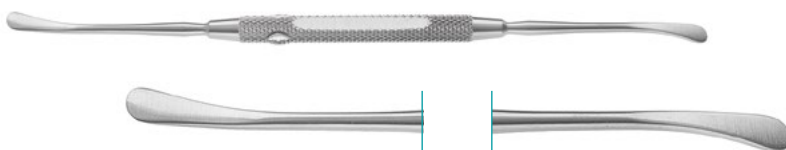
FREER

Septum Elevator, sharp/blunt, 5mm

185mm, 7 ¹ / ₄ "	420-546-180
--	-------------

T_i

 Nerve Micro Dissection Instruments, Titanium
 190mm, 7¹/₂"

†Scale 1:2

†Scale 3:1 (A - S)

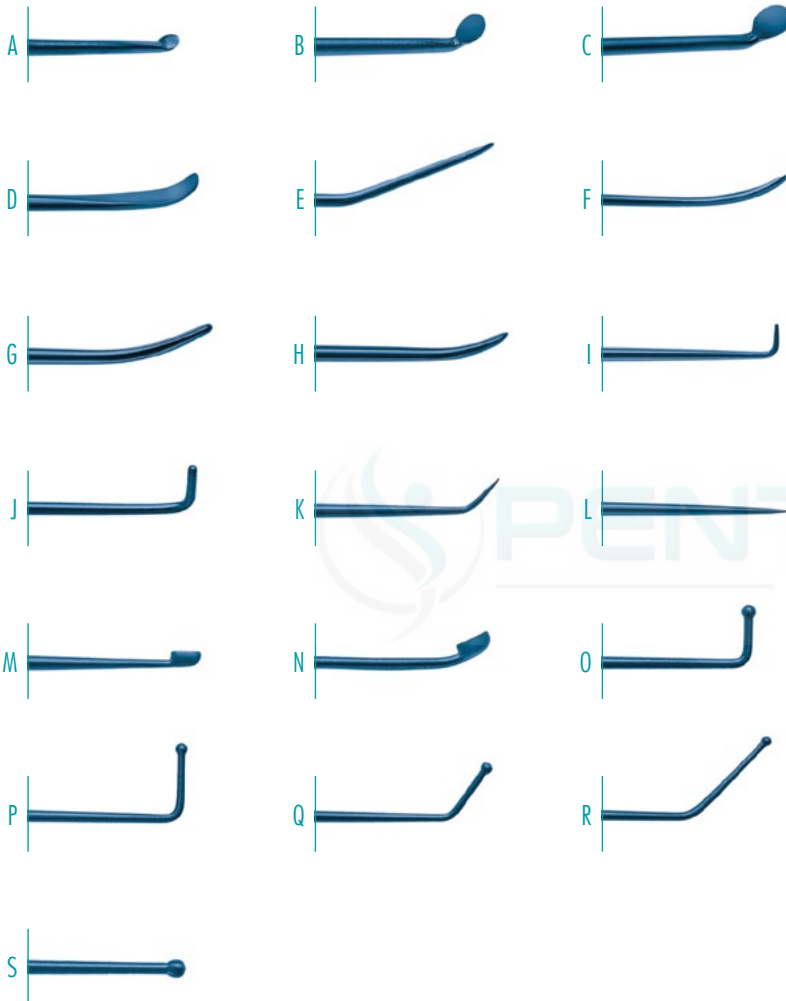

A round, Ø 1mm	250-501-190
B round, Ø 2mm	250-502-190
C round, Ø 3mm	250-503-190
D curved, 2.8mm	250-514-190
E angled, 1.2mm	250-515-190
F narrow, 1.0mm	250-517-190
G medium, 1.5mm	250-518-190
H wide, 2.0mm	250-519-190
I 90°, semi-sharp	250-520-190
J 90°, blunt	250-521-190
K 45°, semi-sharp	250-522-190
L straight, sharp	250-523-190
M straight, 1x2mm	250-524-190
N angled, 1x2mm	250-525-190
O 90°, 3mm	250-526-190
P 90°, 5mm	250-527-190
Q 45°, 4mm	250-528-190
R 45°, 8mm	250-529-190
S straight	250-530-190
T Set (+Tray)	250-501-001

Stainless Steel

A round, Ø 1mm	250-101-190
B round, Ø 2mm	250-102-190
C round, Ø 3mm	250-103-190
D curved, 2.8mm	250-114-190
E angled, 1.2mm	250-115-190
F narrow, 1.0mm	250-117-190
G medium, 1.5mm	250-118-190
H wide, 2.0mm	250-119-190
I 90°, blunt, 2.3mm	250-120-190
J 90°, blunt, 2.9mm	250-121-190
K 45°, semi-sharp	250-122-190
L straight, sharp	250-123-190
M straight, 1x2mm	250-124-190
N angled, 1x2mm	250-125-190
O 90°, 3mm	250-126-190
P 90°, 5mm	250-127-190
Q 45°, 4mm	250-128-190
R 45°, 8mm	250-129-190
S straight	250-130-190
T Set (+tray)	250-101-001

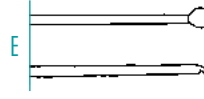
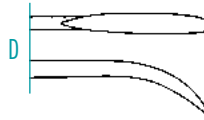
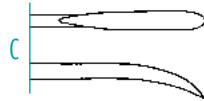
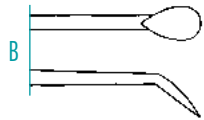
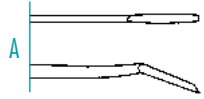

YASARGIL

Micro Raspatory, 185mm, 7¹/₄"

A	250-064-301
B	250-064-303
C	250-064-304
D	250-064-305

Micro Raspatory, round blade,
230mm, 9"

E	250-064-337
F	250-064-338

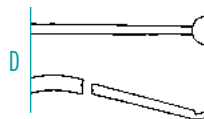
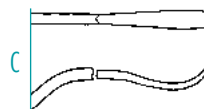
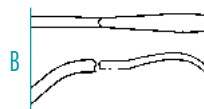
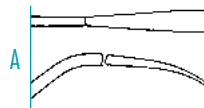
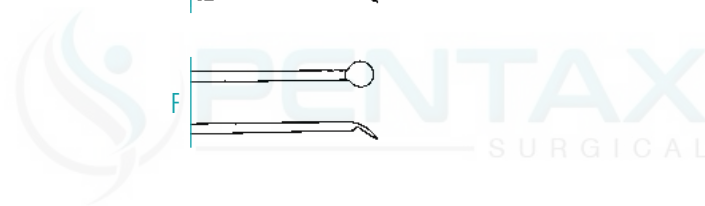

YASARGIL

Micro Raspatory, 185mm, 7¹/₄"

A	250-064-320
B	250-064-321
C	250-064-322

Micro Raspatory, 230mm, 9"

D	250-064-346
---	-------------

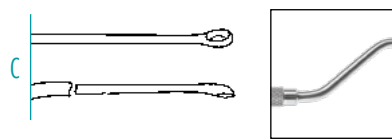
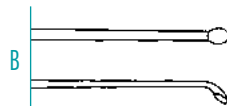
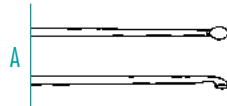

Micro Scoop, 230mm, 9"

A 250-064-335

B 250-064-336

YASARGIL

Micro Raspatory, bayonet-shape, 185mm, 7¹/₄"

C 250-064-325

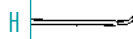
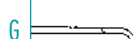
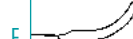
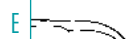
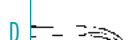
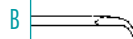

KOOS

Micro Vessel Knife, 185mm, 7¹/₄"

A 250-064-351

B 250-064-352

C 250-064-353

D 250-064-354

E 250-064-356

F 250-064-357

YASARGIL

G 250-064-365

H 250-064-366

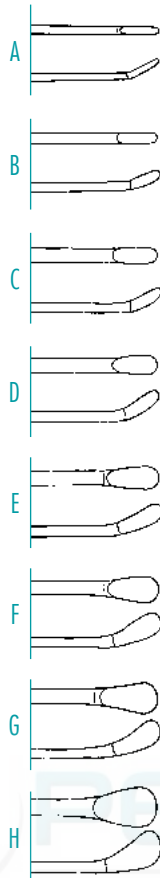

SAMII

Tumor Knife, 200mm, 8"

A 1.0mm	250-064-400
B 1.5mm	250-064-401
C 2.0mm	250-064-402
D 2.5mm	250-064-403
E 3.0mm	250-064-404
F 3.5mm	250-064-405
G 4.0mm	250-064-406
H 5.0mm	250-064-408

230mm, 9"

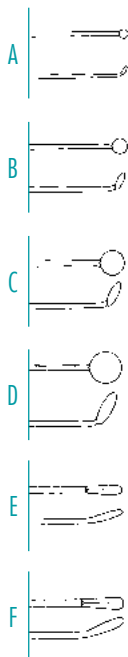
A 1.0mm	250-064-410
B 1.5mm	250-064-411
C 2.0mm	250-064-412
D 2.5mm	250-064-413
E 3.0mm	250-064-414
F 3.5mm	250-064-415
G 4.0mm	250-064-416
H 5.0mm	250-064-418



SAMII

Tumor Knife, 200mm, 8"

A 1.5mm	250-064-851
B 3.0mm	250-064-854
C 4.5mm	250-064-856
D 6.0mm	250-064-858

230mm, 9"

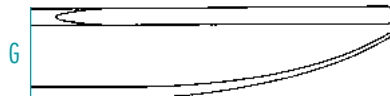
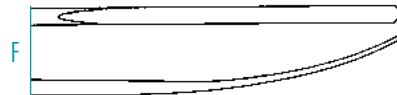
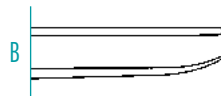
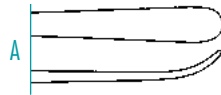
A 1.5mm	250-064-861
B 3.0mm	250-064-864
C 4.5mm	250-064-866
D 6.0mm	250-064-868
E 1.8mm	250-064-298
F 2.5mm	250-064-299



CASPAR

Micro Dissector, 230mm, 9"

A 4.5mm 250-066-303

C 1.4mm 250-064-332

D 2.0mm 250-064-333

E 1.8mm 250-064-334

185mm, 7^{1/4}"

F 3.0mm 250-062-150

200mm, 8"

B 1.0mm 250-066-310

215mm, 8^{1/2}"

G 3.0mm 250-062-151

YASARGIL

185mm, 7^{1/4}"

H 250-064-302



A Nerve Hook, 262mm, 10^{1/4}" bayonet length, black coated, 125mm, 5" working length

left	250-000-043
straight	250-000-042
right	250-000-044



B Micro Nerve Hook

left	250-000-046
straight	250-000-045
right	250-000-047



C Dissector

left	250-000-049
straight	250-000-048
right	250-000-050



A Probe, 269mm, 10^{2/3}" bayonet length, black coated, 125mm, 5" working length

WOODSON	250-000-035
----------------	-------------



B Hook, short, 6mm

left	250-000-037
straight	250-000-036
right	250-000-038



C Hook, long, 9mm

left	250-000-040
straight	250-000-039
right	250-000-041

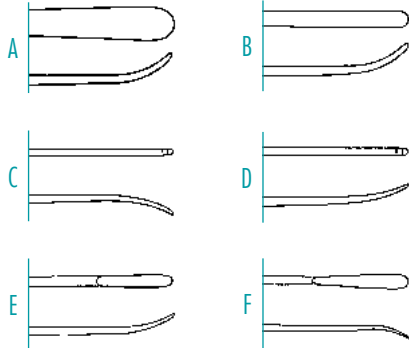
CASPAR

Micro Dissector, 230mm, 9"

A 4.5mm 250-066-305

B 2.0mm 250-066-307

 210mm, 8^{1/4}"

C 1.0mm 250-066-311

D 1.0mm 250-066-312

Micro Dissector, 230mm, 9"

E 250-064-343

F 250-064-344

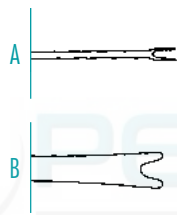
JACOBSON

A Suture Pusher

 185mm, 7^{1/4}" 250-064-315

CASPAR

B Suture Pusher, bayonet-shape

230mm, 9" 250-066-309

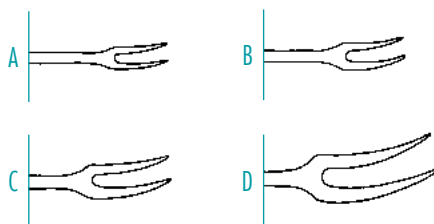
OKONEK YASARGIL

Tumor Fork, 230mm, 9"

A 3.0mm 250-064-380

B 2.0mm 250-064-381

C 5.0mm 250-064-382

D 8.0mm 250-064-384

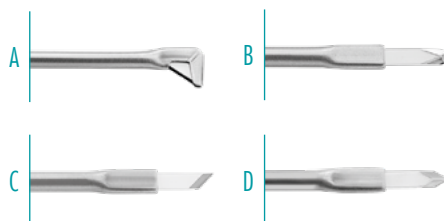

Diamond Knife, 7 facets, single sided

 1.0 x 0.17mm, 205mm, 8^{1/8}"

A hook 1.4 x 0.17mm 250-001-100

B round 250-001-101

C straight, 45° 250-001-102

D lancet, 60° 250-001-103

LEYLAR RETRACTOR SYSTEM



YASARGIL

Retractor, 1 flexible arm, self-retaining, flexible, complete set consisting of:
Fixation (250-066-267)
Flexible Arm (250-066-270)
Flat Spatula Holder (250-066-271)

250-066-260



YASARGIL

Retractor, 2 flexible arms, self-retaining, flexible, complete set consisting of:
Fixation for 2 arms (250-066-268)
Flexible Arm (2x 250-066-270)
Flat Spatula Holder (250-066-271)

250-066-262

LEYLAR RETRACTOR SYSTEM

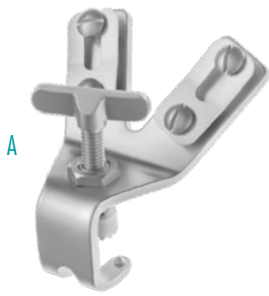

A



B



C

Fixation

A for 2 arms (skull)	250-066-268
B for 1 arm (skull)	250-066-267
C for 1 arm (base)	250-066-266



A

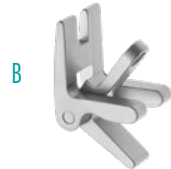

B

YASARGIL

Spatula Holder

A for round shaft	250-066-272
B for flat Spatula	250-066-271



YASARGIL

Spatula, malleable

200 x 9mm	250-066-220
200 x 12mm	250-066-221
250 x 12mm	250-066-222



Spatula, malleable

200 x 14mm	250-066-231
200 x 17mm	250-066-232
200 x 20mm	250-066-233



HEIFETZ

Spatula, malleable

155 x 8mm	250-066-256
155 x 11mm	250-066-257
155 x 14mm	250-066-258
155 x 17mm	250-066-259

LEYLAR RETRACTOR SYSTEM

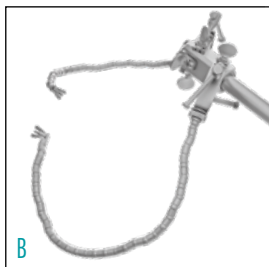
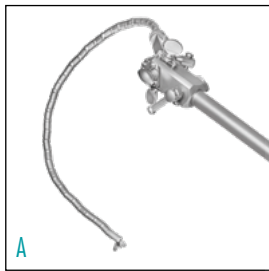
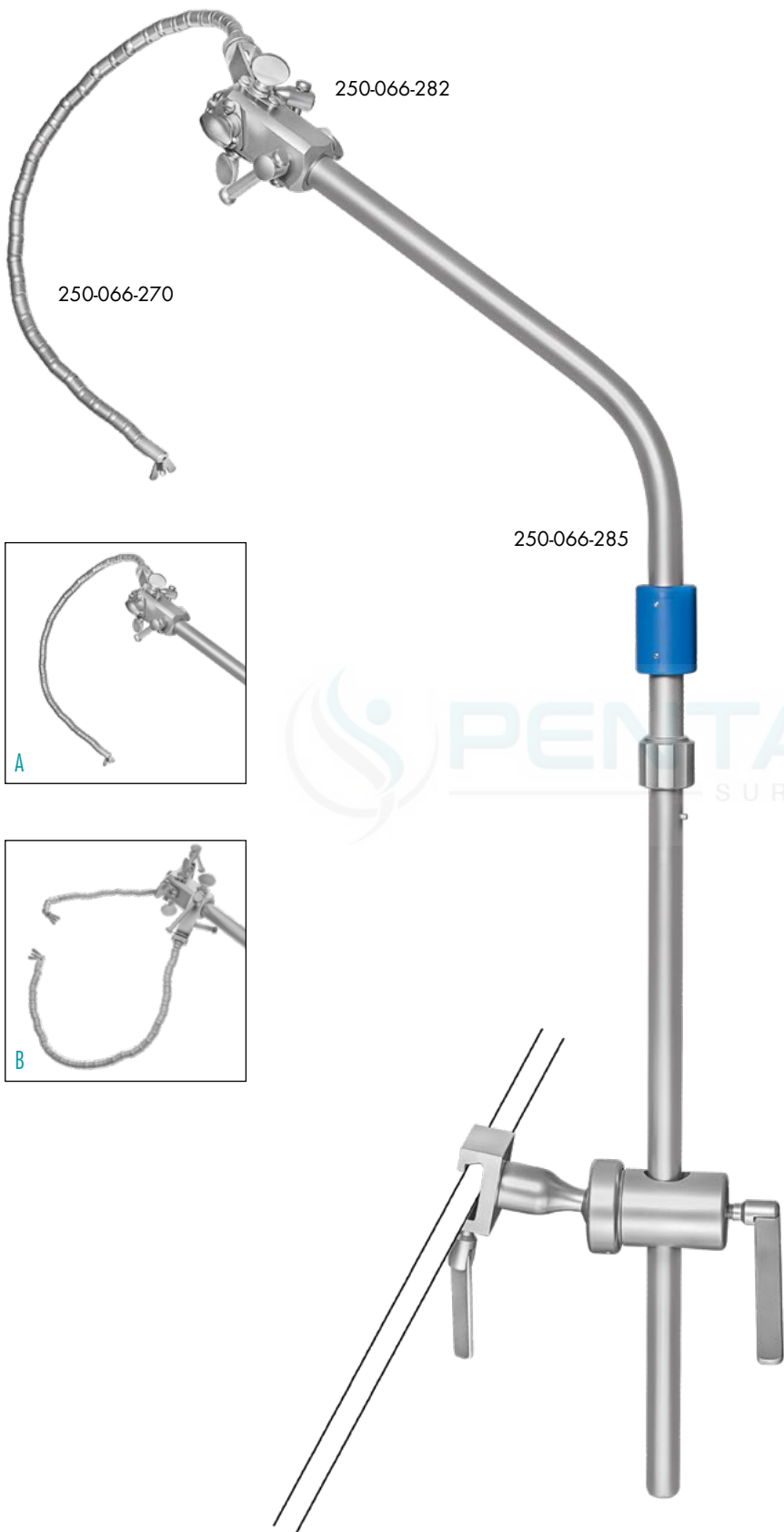

A 250-066-287

LEYLAR

Retractor Set,
1 Arm for fixation to/or table siderails
consisting of:

Ball and socket joint, articulated	250-066-280
Holding rod	250-066-285
Coupling head	250-066-282
Flexible Arm	250-066-270
Flat Spatula Holder	250-066-271

B 250-066-288

2 Arms
consisting of:

Ball and socket joint, articulated	250-066-280
Holding rod	250-066-285
Coupling head	250-066-282
Coupling head, rotatable	250-066-283
Fixation Base	250-066-266
Flexible Arm	250-066-270
Flat Spatula Holder	250-066-271

CUSHING

 Spatula, 170mm, 6²/₃"

7 x 9mm	250-066-212
7 x 9mm CeraCut®	250-066-212CC
8 x 10mm	250-066-213
8 x 10mm CeraCut®	250-066-213CC

200mm, 8"

7 x 9mm	250-066-214
7 x 9mm CeraCut®	250-066-214CC

280mm, 11"

16 x 18mm	250-066-215
16 x 18mm CeraCut®	250-066-215CC

OLIVECRONA

Spatula, flexible, 180mm, 7"

7 x 9mm	250-066-216
11 x 13mm	250-066-217
15 x 18mm	250-066-218
18 x 22mm	250-066-219

CeraCut®

7 x 9mm	250-066-216CC
11 x 13mm	250-066-217CC
15 x 18mm	250-066-218CC
18 x 22mm	250-066-219CC

AACHEN

Spatula, 200mm 8"

7 x 8mm	250-066-441
11 x 11mm	250-066-442
13 x 14mm	250-066-443
16 x 17mm	250-066-444
19 x 20mm	250-066-445
22 x 25mm	250-066-446

SCOVILLE

Spatula, 203mm, 8"

13 x 9.5mm	250-066-202
19 x 16mm	250-066-203

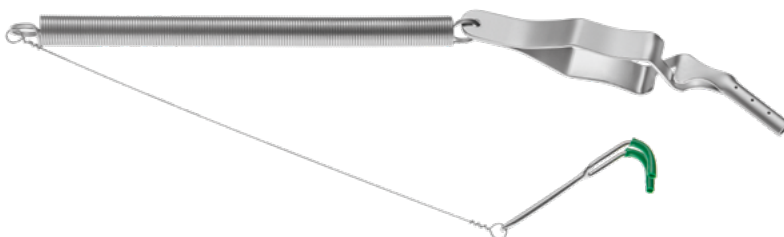
YASARGIL

 Galea Hook, 310mm, 12¹/₄"

Ø 7mm	250-066-020
410mm, 16"	
Ø 9mm	250-066-022

GRUENBERG RETRACTOR & HAND REST SYSTEM

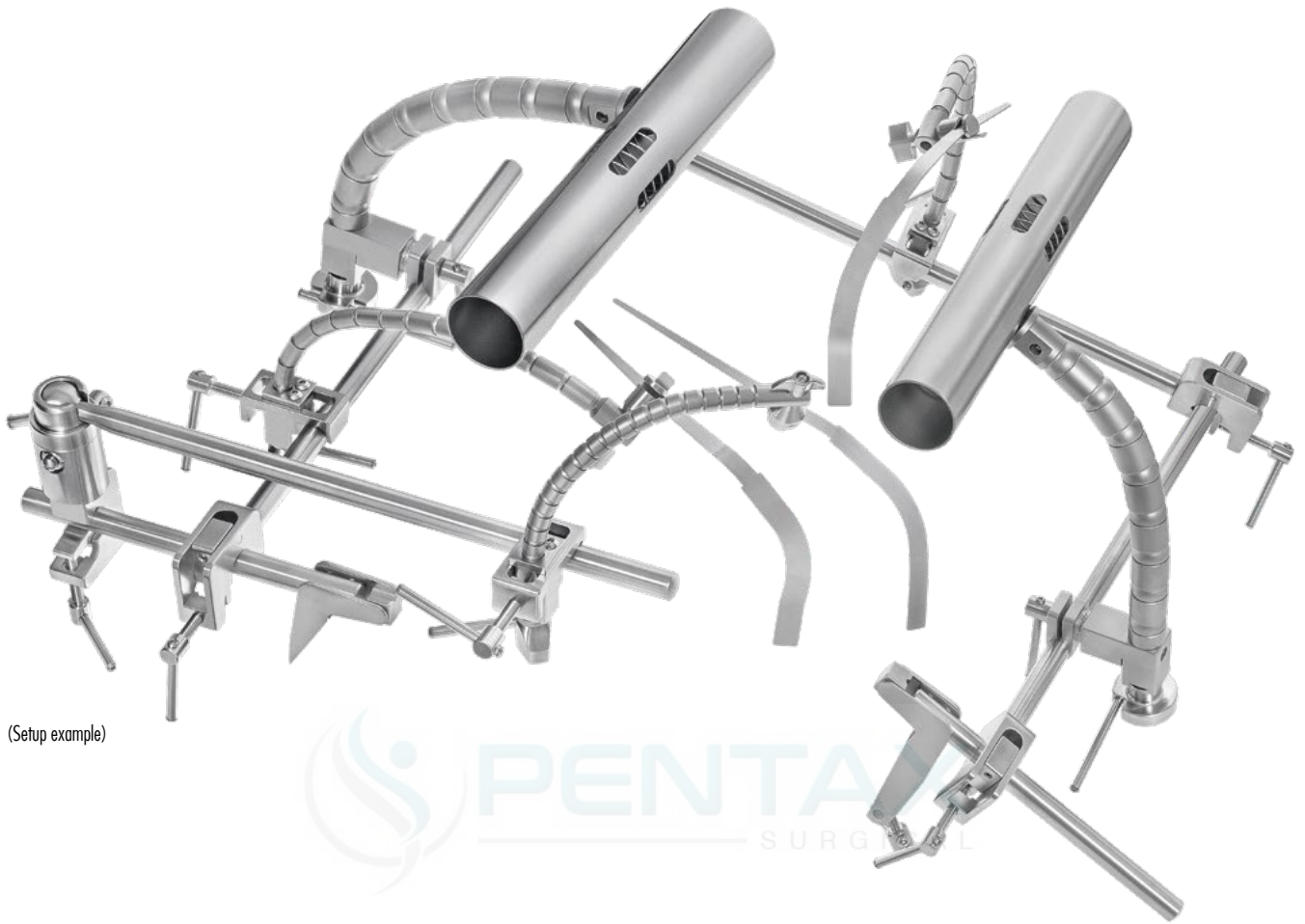

(Setup example)

250-050-150

GRUENBERG

Retractor Kit, consisting of:

Primary Bar (2x)	250-050-007
Secondary Bar (4x)	250-050-002
Large Arm Retractor (4x)	250-050-009
Blade 1.6 x 19mm (1x)	250-050-050
Blade 2.0 x 10mm (1x)	250-050-051
Blade 3.0 x 13mm (1x)	250-050-052
Blade 4.0 x 16mm (1x)	250-050-053
Blade 6.0 x 19mm (1x)	250-050-054
Hand Rest (1x)	250-050-012
Pattie Tray (1x)	250-066-513

GRUENBERG RETRACTOR & HAND REST SYSTEM

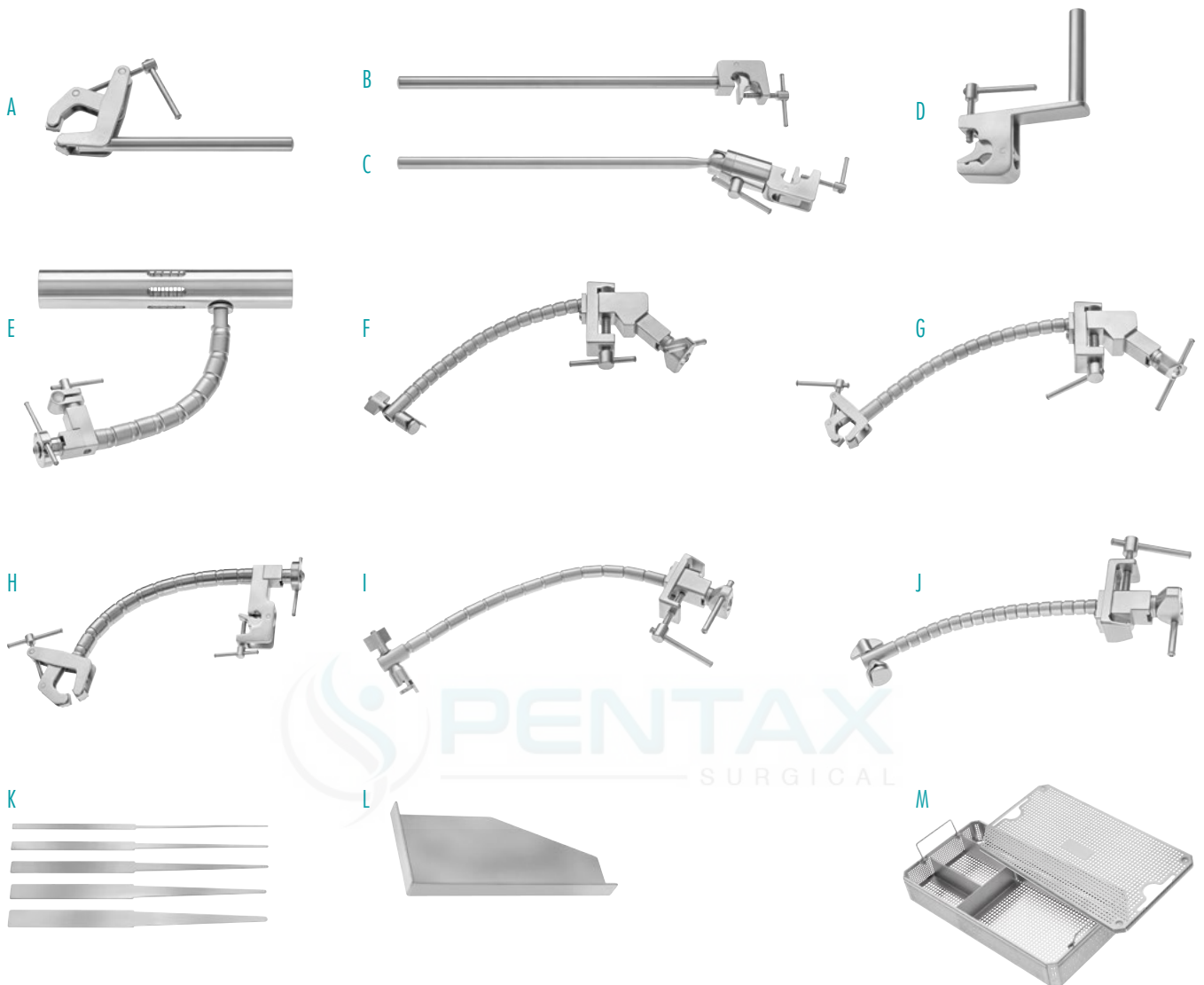

GRUENBERG

Single Parts

A	Primary Bar, 152mm	250-050-007	K	Blade, 1.6 x 19mm	250-050-050
B	Secondary Bar, 305mm	250-050-002		Blade, 2.0 x 10mm	250-050-051
C	Floating Secondary Bar	250-050-003		Blade, 3.0 x 13mm	250-050-052
D	Short Coupler	250-050-004		Blade, 4.0 x 16mm	250-050-053
E	Hand Rest	250-050-012		Blade, 6.0 x 19mm	250-050-054
F	Small Instrument Holder (up to 8mm)	250-050-030	L	Pattie Tray with towel clamps, 75 x 170 x 20mm	250-066-513
G	Large Instrument Holder (up to 25mm)	250-050-031	M	Sterilization Tray with 4 components, 480 x 253 x 70mm	600-050-514
H	Extra Large Instrument Holder (up to 51mm)	250-050-032			
I	Micro Instrument Holder (up to 3mm)	250-050-033			
J	Arm Retractor, short (165mm)	250-050-011			
	Arm Retractor, large (240mm)	250-050-009			



A MF Headrest System,
complete with skull clamp

Aluminium 250-140-100



B MF Headrest System,
with horseshoe headrest

Aluminium 250-140-105

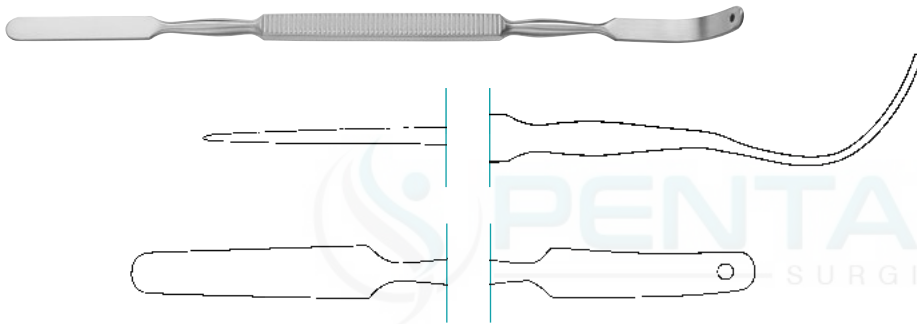

MCDONALD

Elevator, straight / curved

190mm, 7¹/₂"

210-527-190

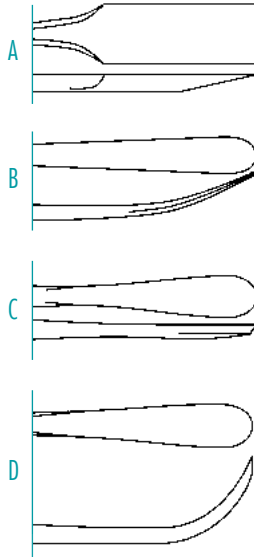

ADSON

Elevator, 8mm, 170mm, 6²/₃"

A straight, sharp 210-484-170

B curved, blunt 210-485-170

7mm

C straight, semi-sharp 210-486-170

D curved, semi-sharp 210-487-170

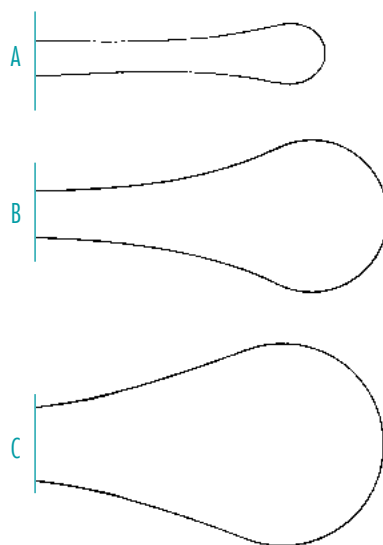

HOEN

Periosteal Elevator, 7mm

A 160mm, 6¹/₄" 210-455-007

15mm

B 185mm, 7¹/₄" 210-455-015

20mm

C 190mm, 7¹/₂" 210-455-020



CUSHING

Periosteal Elevator
sharp end with rounded edge, 15mm

A 190mm, 7¹/₂" 210-460-001

sharp end with square edge

B 190mm, 7¹/₂" 210-460-003

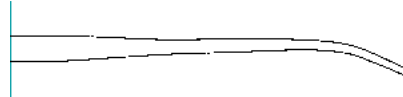
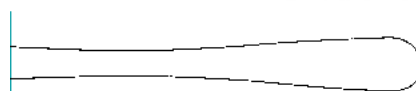

CUSHING LITTLE JOKER

Periosteal Elevator

150mm, 6" 210-488-150

190mm, 7¹/₂" 210-488-190

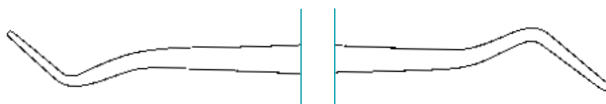

WOODSON

Elevator and Spatula, semi-sharp, 3mm,
flat end 4mm

254mm 10" 250-746-250



CLOWARD

Osteophyte Elevator, round handle,
90° curved tip, sharp

200mm, 8" 259-252-000

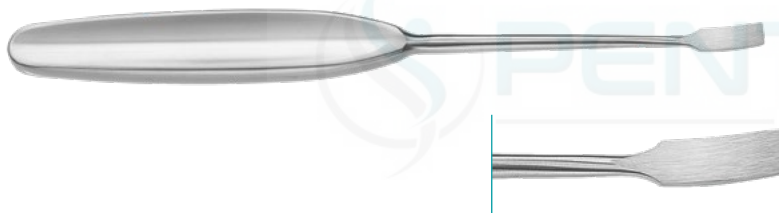

Periosteal Elevator
curved tip, 200mm, 8"

5.0mm 250-285-394

6.5mm 250-285-395

8.0mm 250-285-396

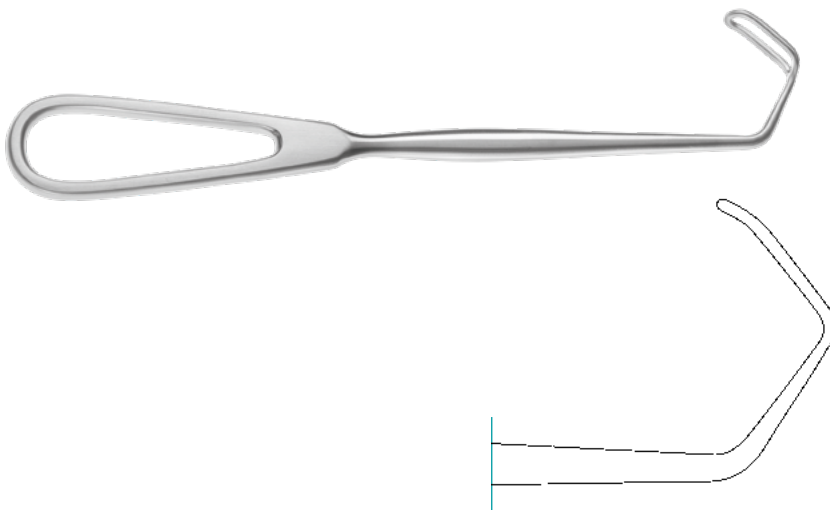

CUSHING

Retractor
22mm wide, open handle

210mm, 8^{1/4}" 170-237-210



LOVE

Nerve Root Retractor
190mm, 7^{1/2}"

straight	250-694-190
45°	250-695-190
90°	250-697-190

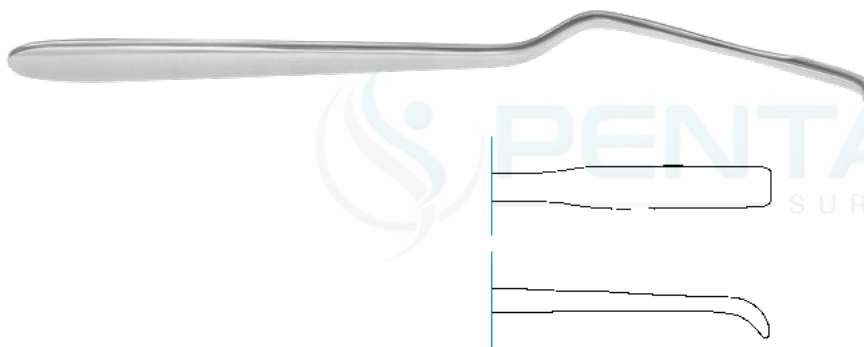

D'ERRICO

Nerve Spatula, bayonet shaped,
6mm wide

230mm, 9"	250-689-230
-----------	-------------

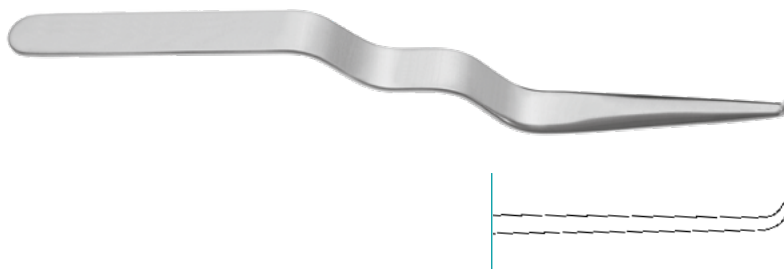

KRAYENBÜHL

Nerve Root Retractor
with guide groove, double bayonet shaped

210mm, 8 ^{1/4} "	250-688-210
245mm, 9 ^{2/3} "	250-688-245

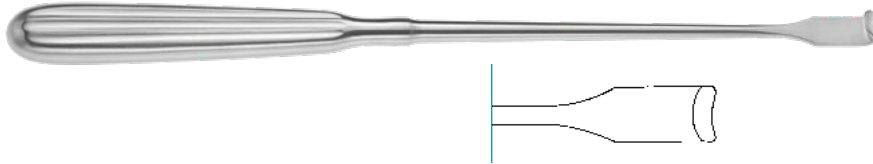

SCOVILLE

Nerve Root Retractor, 230mm, 9"

straight	250-698-230
45°	
90°	

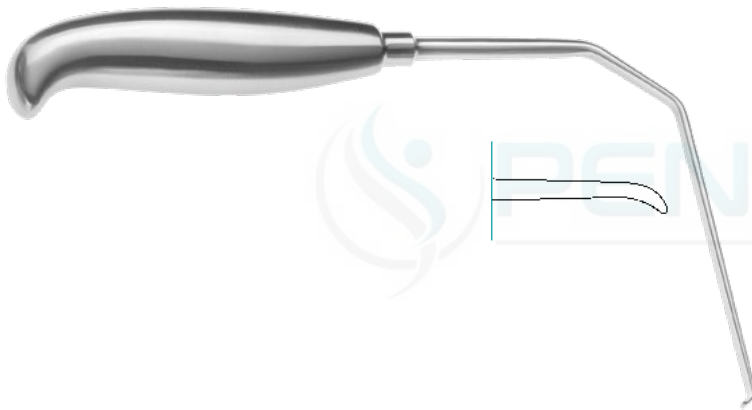

HESS

Nerve Root Retractor, angled
175mm, 6⁷/₈"

3mm	250-690-030
4mm	250-690-040
5mm	250-690-050
7mm	250-690-070

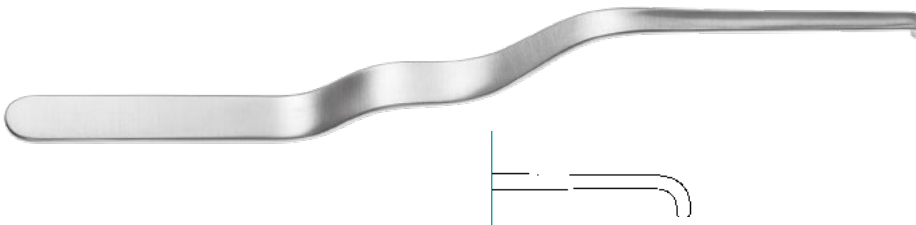

CASPAR

Nerve Root Retractor
240mm, 9¹/₂"

4mm	250-690-240
6mm	250-691-240
8mm	250-692-240
10mm	250-693-240

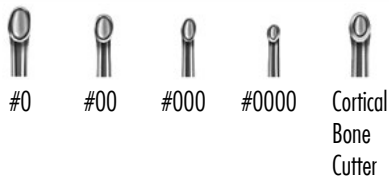

A Forward straight

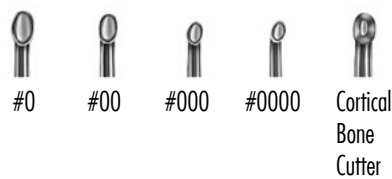
B Forward angled

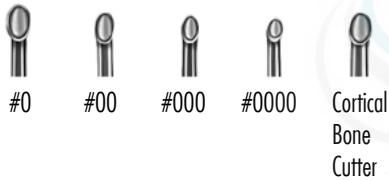
C Backward straight

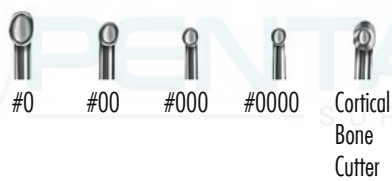
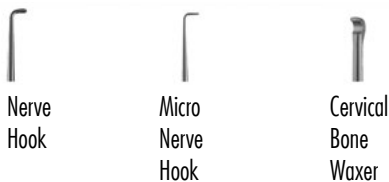
D Backward angled

E Hooks

 Microdissectomy
 Cervical Curette, 210mm, 8¹/₄"

A forward straight

#0	259-100-100
#00	259-100-200
#000	259-100-300
#0000	259-100-400
Cortical Bone Cutter	259-100-500

B forward angled

#0	259-101-100
#00	259-101-200
#000	259-101-300
#0000	259-101-400
Cortical Bone Cutter	259-101-500

C backward straight

#0	259-102-100
#00	259-102-200
#000	259-102-300
#0000	259-102-400
Cortical Bone Cutter	259-102-500

D backward angled

#0	259-103-100
#00	259-103-200
#000	259-103-300
#0000	259-103-400
Cortical Bone Cutter	259-103-500

E Hooks

Nerve Hook	259-104-001
Micro Nerve Hook	259-104-002
Cervical Bone Waxer	259-104-003



A Forward straight

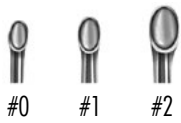

B Forward angled



C Forward down angled



D Backward straight

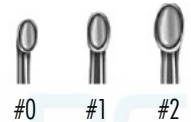

E Backward angled

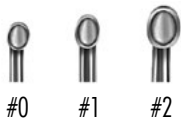

F Backward down angled



G Instruments

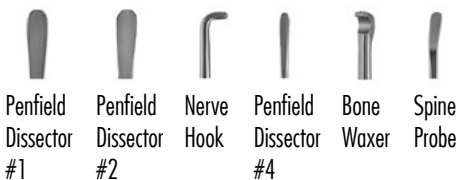

Penfield Dissector #1 Penfield Dissector #2 Nerve Hook Penfield Dissector #4 Bone Waxer Spine Probe

Microdissectomy Lumbar Curette, 240mm, 9 1/2"

A forward straight

#0	259-120-100
#1	259-120-001
#2	259-120-002

B forward angled

#0	259-121-100
#1	259-121-001
#2	259-121-002

C forward down angled

#0	259-122-100
#1	259-122-001
#2	259-122-002

D backward straight

#0	259-124-100
#1	259-124-001
#2	259-124-002

E backward angled

#0	259-125-100
#1	259-125-001
#2	259-125-002

F backward down angled

#0	259-126-100
#1	259-126-001
#2	259-126-002

G Instruments

Penfield Dissector #1	259-127-001
Penfield Dissector #2	259-127-002
Nerve Hook	259-127-003
Penfield Dissector #4	259-127-004
Bone Waxer	259-127-005
Spine Probe	259-127-006



A Forward straight

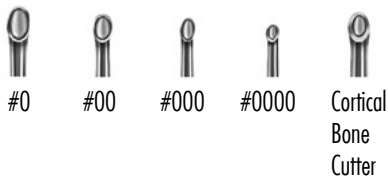

B Forward angled

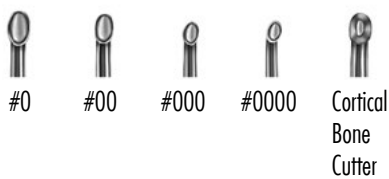

C Backward straight

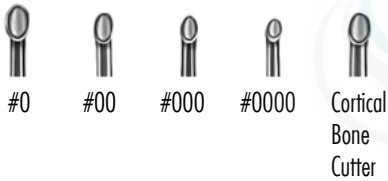

D Backward angled

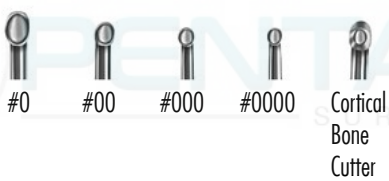

E Hooks

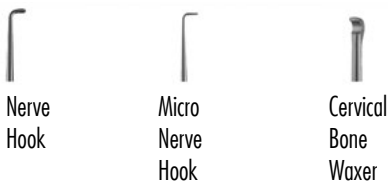

Microdiscectomy
Cervical Curette, 240mm, 9 1/2"

A forward straight

#0	259-110-100
#00	259-110-200
#000	259-110-300
#0000	259-110-400
Cortical Bone Cutter	259-110-500

B forward angled

#0	259-111-100
#00	259-111-200
#000	259-111-300
#0000	259-111-400
Cortical Bone Cutter	259-111-500

C backward straight

#0	259-112-100
#00	259-112-200
#000	259-112-300
#0000	259-112-400
Cortical Bone Cutter	259-112-500

D backward angled

#0	259-113-100
#00	259-113-200
#000	259-113-300
#0000	259-113-400
Cortical Bone Cutter	259-113-500

E Hooks

Nerve Hook	259-114-001
Micro Nerve Hook	259-114-002
Cervical Bone Waxer	259-114-003



259-100-000
Cervical Microdiscectomy Set
consisting of:

- 259-100-200
- 259-100-300
- 259-100-400
- 259-101-100
- 259-101-300
- 259-101-400
- 259-102-300
- 259-102-400
- 259-103-200
- 259-103-300
- 259-104-001
- 259-104-002
- 600-404-000

259-110-000
Cervical Microdiscectomy Set
consisting of:

- 259-110-100
- 259-110-300
- 259-110-400
- 259-111-100
- 259-111-200
- 259-111-300
- 259-112-100
- 259-112-200
- 259-112-300
- 259-113-100
- 259-113-300
- 259-113-400
- 600-404-000

259-120-000
Lumbar Microdiscectomy Set
consisting of:

- 259-120-001
- 259-120-002
- 259-121-001
- 259-121-002
- 259-122-001
- 259-122-002
- 259-124-002
- 259-125-001
- 259-126-100
- 259-126-001
- 259-127-001
- 259-127-004
- 600-404-000

Case for Micro Curettes,
12 Instruments (not illustrated)

265 x 255 x 45mm 600-404-000

A Bayonet straight

B Bayonet 45° angled

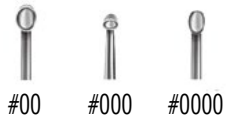
C Bayonet 80° angled

Micro Spinal Curettes, 210mm, 8^{1/4}"
A Bayonet straight

#00	259-140-200
#000	259-140-300
#0000	259-140-400

B Bayonet 45° angled

#00	259-141-200
#000	259-141-300
#0000	259-141-400

C Bayonet 80° angled

#00	259-142-200
#000	259-142-300
#0000	259-142-400

A Forward angled

B Backward angled

C Dissectors

Micro Spinal Curette, 250mm, 9^{7/8}"
A forward angled

#1	259-130-001
#2	259-130-002
#3	259-130-003
#4	259-130-004
#5	259-130-005

B backward angled

#1	259-131-001
#2	259-131-002
#3	259-131-003
#4	259-131-004
#5	259-131-005

C Dissector, straight

3mm	259-132-003
5mm	259-132-005

Curette measurements

Overall length	320mm, 12 ¹ / ₂ "
Handle length	200mm, 8"
Working length	125mm, 5"
Handle diameter	28mm, 1 ¹ / ₁₀ "

XL Curette measurements

Overall length	340mm, 13 ¹ / ₃ "
Handle length	220mm, 8 ² / ₃ "
Working length	125mm, 5"
Handle diameter	32mm, 1 ¹ / ₃ "

Cup Curette Set with 12 Curettes
 consisting of:
 straight

A	7mm	259-152-007
B	9mm	259-152-009
C	11mm	259-152-011
D	13mm	259-152-013
E	15mm	259-152-015
F	17mm	259-152-017
G	19mm	259-152-019
forward angled		
H	7mm	259-152-107
I	9mm	259-152-109
J	11mm	259-152-111
backward angled		
K	7mm	259-152-207
L	9mm	259-152-209



Straight



Forward angled



Backward angled

Cup Curette Set with 12 XL Curettes
 consisting of:
 straight

A	7mm	259-155-007
B	9mm	259-155-009
C	11mm	259-155-011
D	13mm	259-155-013
E	15mm	259-155-015
F	17mm	259-155-017
G	19mm	259-155-019
forward angled		
H	7mm	259-155-107
I	9mm	259-155-109
J	11mm	259-155-111
backward angled		
K	7mm	259-155-207
L	9mm	259-155-209



Chisel Set with 6 Chisels, straight
consisting of:

A	6mm	259-151-006
B	10mm	259-151-010
C	15mm	259-151-015
D	20mm	259-151-020
E	25mm	259-151-025
F	30mm	259-151-030
Sterilizing Case		259-151-002

Chisel measurements

Overall length	270mm, 10 ² / ₃ "
Handle length	145mm, 5 ³ / ₄ "
Working length	125mm, 5"
Handle diameter	32mm, 1 ¹ / ₃ "

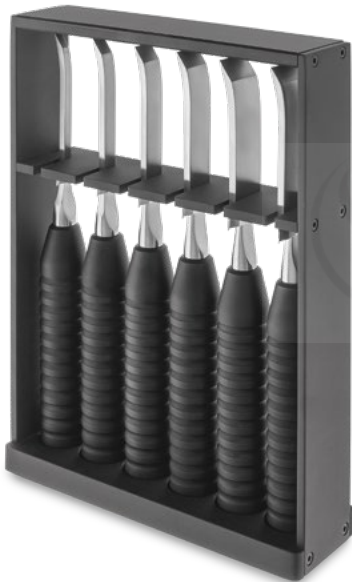

Chisel Set with 6 Chisels, curved
consisting of:

A	6mm	259-151-106
B	10mm	259-151-110
C	15mm	259-151-115
D	20mm	259-151-120
E	25mm	259-151-125
F	30mm	259-151-130
Sterilizing Case		259-151-002



A



B



C



D

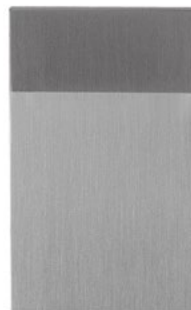

E

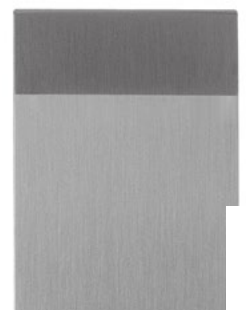

F



Ring Curette measurements

Overall length	320mm, 12 ¹ / ₂ "
Handle length	200mm, 8"
Working length	125mm, 5"
Handle diameter	28mm, 1 ¹ / ₁₀ "

XL Ring Curette measurements

Overall length	340mm, 13 ¹ / ₃ "
Handle length	220mm, 8 ² / ₃ "
Working length	125mm, 5"
Handle diameter	32mm, 1 ¹ / ₃ "

Ring Curette Set with 6 Ring Curettes consisting of:

straight		
A	6mm	259-153-006
B	8mm	259-153-008
C	11mm	259-153-010

angled

A	6mm	259-153-106
B	8mm	259-153-108
C	11mm	259-153-110

Ring Curette Set with 6 XL Ring Curettes consisting of:

straight		
A	6mm	259-154-006
B	8mm	259-154-008
C	11mm	259-154-010

angled

A	6mm	259-154-106
B	8mm	259-154-108
C	11mm	259-154-110



straight



angled



A

B

C



A

B

C



Elevator measurements

Overall length	320mm, 12 ¹ / ₂ "
Handle length	200mm, 8"
Working length	125mm, 5"
Handle Diameter	28mm, 1 ¹ / ₁₀ "

XL Elevator measurements

Overall length	340mm, 13 ¹ / ₃ "
Handle length	220mm, 8 ² / ₃ "
Working length	125mm, 5"
Handle diameter	32mm, 1 ¹ / ₃ "

Elevator Set with 6 Elevators consisting of:

A	10mm	259-157-010
B	15mm	259-157-015
C	20mm	259-157-020
D	25mm	259-157-025
E	30mm	259-157-030
F	35mm	259-157-035

Elevator Set with XL 6 Elevators consisting of:

A	10mm	259-158-010
B	15mm	259-158-015
C	20mm	259-158-020
D	25mm	259-158-025
E	30mm	259-158-030
F	35mm	259-158-035



A



B



C



D



E



F



SMITH PETERSON

Mallet with brass head, aluminium handle,
Ø 38mm, 282g

Overall length 259-149-165
165mm, 6¹/₂"



Mallet, large, Ø 31.8mm, 340g

Overall length 259-149-002
247mm, 9²/₃"



Mallet, small, Ø 22.5mm, 193g

Overall length 259-149-001
241mm, 9¹/₃"



CLOWARD

Retractor, 112mm handle length

70x13mm	259-260-001
75x18mm	259-260-002
75x20mm	259-260-003
75x23mm	259-260-004



TAYLOR

Spinal Retractor, 185mm, 7¹/₄"

70x30mm	210-571-165
85x30mm	210-572-165
100x30mm	210-573-165



HIBBS

Retractor, Fig. 0, 230mm, 9"

25x13mm	170-200-000
Fig. 1, 230mm, 9"	
75x25mm	170-200-001
Fig. 2, 240mm, 9 ¹ / ₂ "	
80x25mm	170-200-002



HIBBS

2-piece Retractor Set
19x50mm blade

235mm, 9¹/₄" 250-979-235



INGE

Lamina Spreader, with teeth

170mm, 6²/₃" 250-975-170

270mm, 10²/₃" 250-975-270



Lamina Spreader

265mm, 10¹/₂" 250-978-265



CUSHING LANDOLT

Specula for transsphenoidal hypophysectomy,
black finishing

70 x 15mm	250-150-100
100 x 15mm	250-150-102



PAPAVERO CASPAR

Specula for trans-sphenoidal hypophysectomy,
stainless steel

80 x 11mm	250-150-589
90 x 13mm	250-150-590
100 x 15mm	250-150-591

black finishing

80 x 11mm	250-150-689
90 x 13mm	250-150-690
100 x 15mm	250-150-691

Key for specula

250-150-592



Transnasal Speculum, stainless steel, matted

80 x 9mm	250-150-280
90 x 9mm	250-150-290
100 x 9mm	250-150-300



MEYERDING

Laminectomy Retractor, 200mm, 8"

25x32mm blade	170-791-001
25x54mm blade	170-791-002
19x60mm blade	170-791-003
25x60mm blade	170-791-004



MEYERDING

Hemi Laminectomy Retractor, 180mm, 7"

10mm wide blade, solid blade left

50mm	170-792-001
60mm	170-792-002
70mm	170-792-006

solid blade right

50mm	170-793-001
60mm	170-793-008
70mm	170-793-007

20mm wide blade, solid blade left

50mm	170-792-004
60mm	170-792-003
70mm	170-792-005

solid blade right

50mm	170-793-004
60mm	170-793-005
70mm	170-793-002



MARKHAM MEYERDING

Laminectomy Retractor, 165mm, 6^{1/2}"

solid blade left

25x65mm	170-790-007
---------	-------------

solid blade right

25x65mm	170-790-008
---------	-------------



Vertebral Distractor, 127mm length

18mm spread 250-259-018

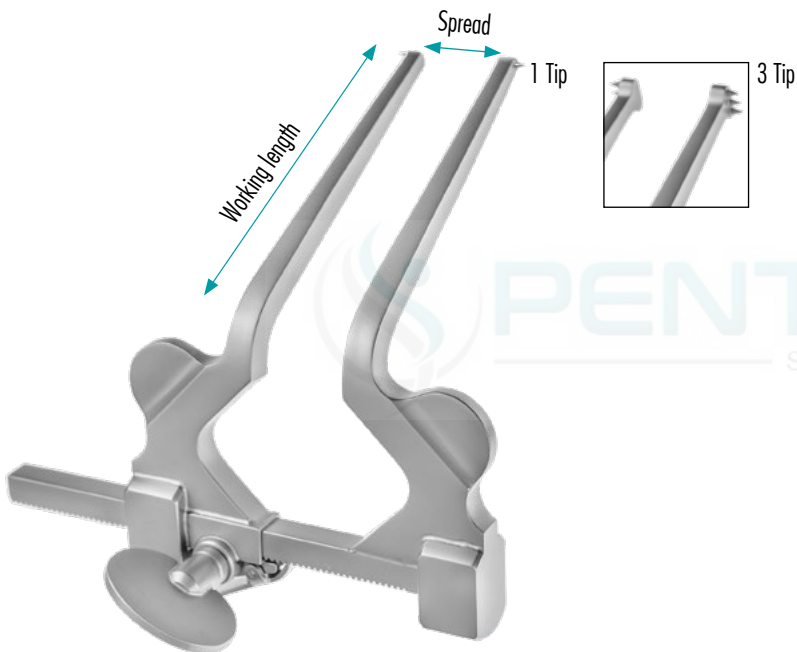

Vertebral Distractor, with 3 tips,
70mm working length

70mm spread 250-259-070



CLOWARD

Lamina Spreader

160mm, 6¹/₄" 250-973-160



CLOWARD

Self-Retaining Retractor Set, 150mm, 6"
complete with 5 blades

58mm spread 170-780-160

Blades

40mm, 1⁵/₈" 170-780-040

45mm, 1⁶/₈" 170-780-045

50mm, 2" 170-780-050

55mm, 2¹/₈" 170-780-055

60mm, 2³/₈" 170-780-060



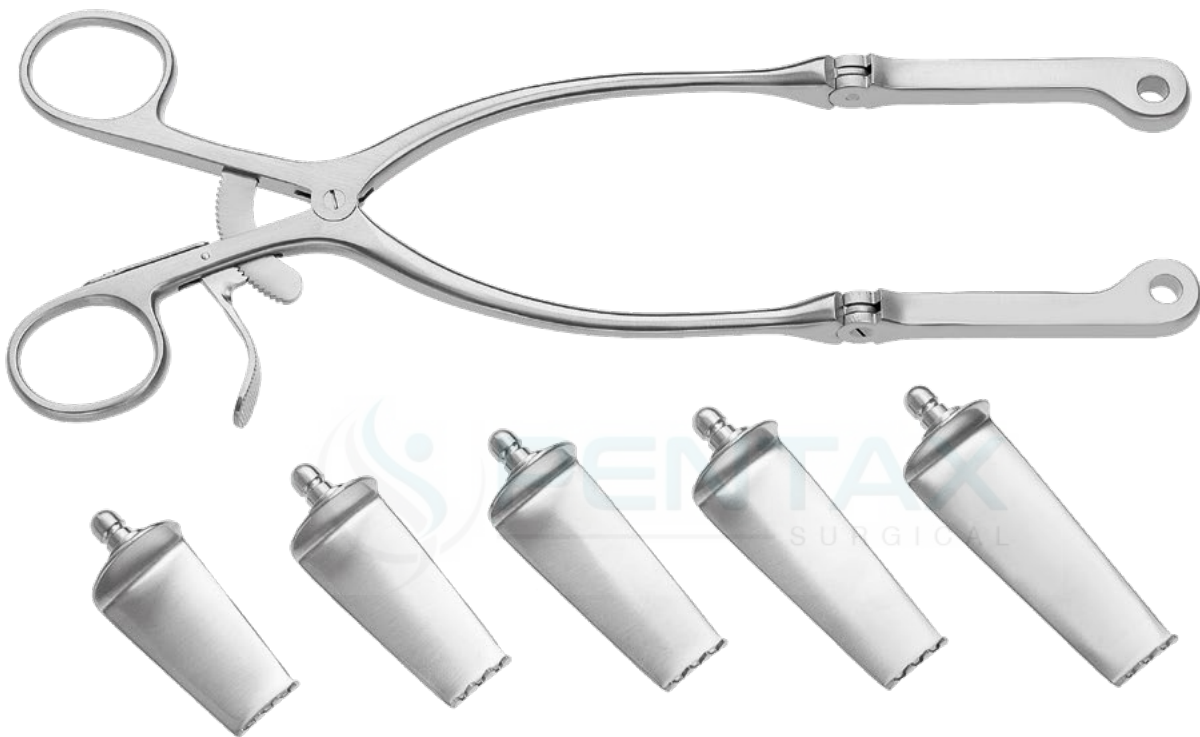

CLOWARD

Self-Retaining Retractor Set, 250mm, 9⁷/₈"
complete with 5 pairs of blades

170-774-000

Blades (pair)

40mm, 1 ⁵ / ₈ "	170-774-040
45mm, 1 ⁶ / ₈ "	170-774-045
50mm, 2"	170-774-050
55mm, 2 ¹ / ₈ "	170-774-055
60mm, 2 ³ / ₈ "	170-774-060

SCOVILLE DISTRACTOR



SCOVILLE HAVERFIELD

Spreader, rigid arms, without valves

171mm spread	170-906-000
--------------	-------------

hinged arms, without valves

171mm spread	170-906-001
--------------	-------------



Hook, blunt

51mm	170-906-102
75mm	170-906-104



Hook, with crossbar

51mm	170-906-106
75mm	170-906-108



Blade, toothed

26 x 63mm	170-906-122
51 x 63mm	170-906-124
32 x 66mm	170-906-126
26 x 89mm	170-906-128



Blade, forked, blunt

38 x 41mm	170-906-144
48 x 66mm	170-906-145



MEYERDING

Blade, toothed

26 x 61mm	170-906-162
26 x 67mm	170-906-164
51 x 89mm	170-906-166



HIBBS

Blade, toothed

26 x 51mm	170-906-182
51x 51mm	170-906-184
26 x 63mm	170-906-186
38 x 63mm	170-906-188
26 x 76mm	170-906-190
38 x 76mm	170-906-192
51 x 76mm	170-906-194
26 x 101mm	170-906-196
51 x 101mm	170-906-198

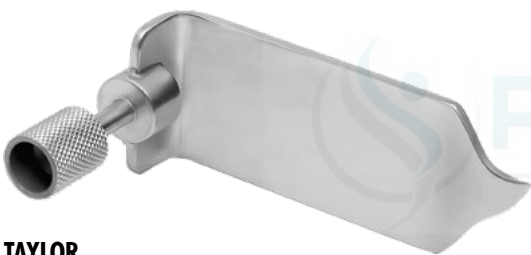

TAYLOR

Blade

32 x 76mm	170-906-120
32 x 101mm	170-906-121



TAYLOR

Blade, forked, sharp

38 x 44mm	170-906-132
-----------	-------------



TAYLOR

Blade, forked, blunt

51 x 48mm	170-906-141
63 x 63mm	170-906-142
58 x 82mm	170-906-143

CASPAR CERVICAL DISTRACTOR



CASPAR
Cervical Distractor System



CASPAR
Cervical Distractor with 110mm rack
for two-level distraction

left approach	259-190-110
right approach	259-190-111

with 130mm rack
for multi-level distraction

left approach	259-190-130
right approach	259-190-131



CASPAR
Drill Guide

left	259-190-200
right	259-190-300

CASPAR CERVICAL DISTRACTOR



CASPAR

Drill Bit, 2.35mm shank, 148mm overall length
Ø 1.7mm

8mm drilling depth 259-190-408

14mm drilling depth 259-190-414



CASPAR

Distraction Screw, self-drilling

12mm 259-190-512

14mm 259-190-514

16mm 259-190-516

18mm 259-190-518



CASPAR

Screw Driver, 200mm overall length

259-190-550

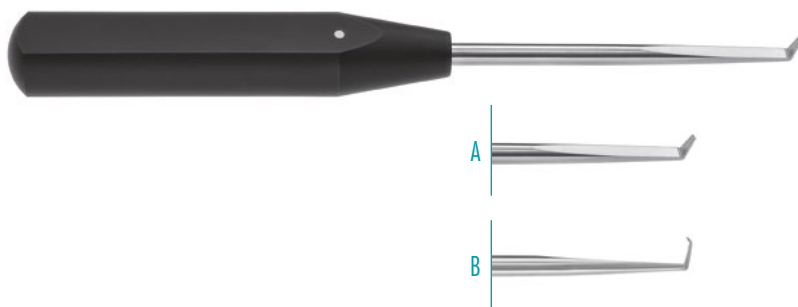

CASPAR

Dissector, 205mm, 8¹/₄"

A 259-185-917

B 259-185-918

CASPAR CERVICAL RETRACTOR SYSTEM



CASPAR

CCR Basis Retractor, double hinged arms,
reverse butterfly screw, distal hinge made of
titanium

259-180-490



CASPAR

Basis Counter Retractor, double hinged arms,
distal hinge made of titanium

259-180-470



CASPAR

Counter Retractor, distal hinge made of titanium

259-180-480

CASPAR CERVICAL RETRACTOR SYSTEM



CASPAR

Side Load Handle for use with titanium blades
259-180-100



CASPAR

Caspar Handle for blades, side load,
cannulated, with Luer Lock, ratchet mechanism
259-180-101



CASPAR

Depth Gauge
259-180-200

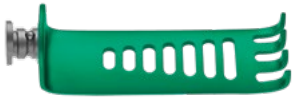

Titanium Medial/Lateral Blade, 4 prongs,
19mm width

25mm	259-180-125
30mm	259-180-130
35mm	259-180-135
40mm	259-180-140
45mm	259-180-145
50mm	259-180-150
55mm	259-180-155
60mm	259-180-160
65mm	259-180-165
70mm	259-180-170
75mm	259-180-175

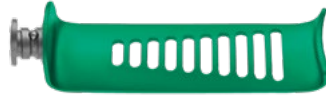

Titanium Longitudinal Blade, blunt
19mm width

25mm	259-180-225
30mm	259-180-230
35mm	259-180-235
40mm	259-180-240
45mm	259-180-245
50mm	259-180-250
55mm	259-180-255
60mm	259-180-260
65mm	259-180-265
70mm	259-180-270
75mm	259-180-275

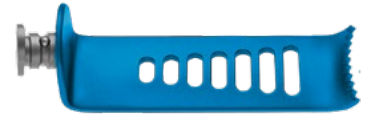

Titanium Lateral Blade, 8 teeth
24mm width

25mm	259-180-325
30mm	259-180-330
35mm	259-180-335
40mm	259-180-340
45mm	259-180-345
50mm	259-180-350
55mm	259-180-355
60mm	259-180-360
65mm	259-180-365
70mm	259-180-370
75mm	259-180-375



Titanium Medial Blade, 5 prongs,
24mm width

25mm	259-180-425
30mm	259-180-430
35mm	259-180-435
40mm	259-180-440
45mm	259-180-445
50mm	259-180-450
55mm	259-180-455
60mm	259-180-460
65mm	259-180-465
70mm	259-180-471
75mm	259-180-475



Titanium Longitudinal Blade, blunt
24mm width

25mm	259-180-525
30mm	259-180-530
35mm	259-180-535
40mm	259-180-540
45mm	259-180-545
50mm	259-180-550
55mm	259-180-555
60mm	259-180-560
65mm	259-180-565
70mm	259-180-570
75mm	259-180-575

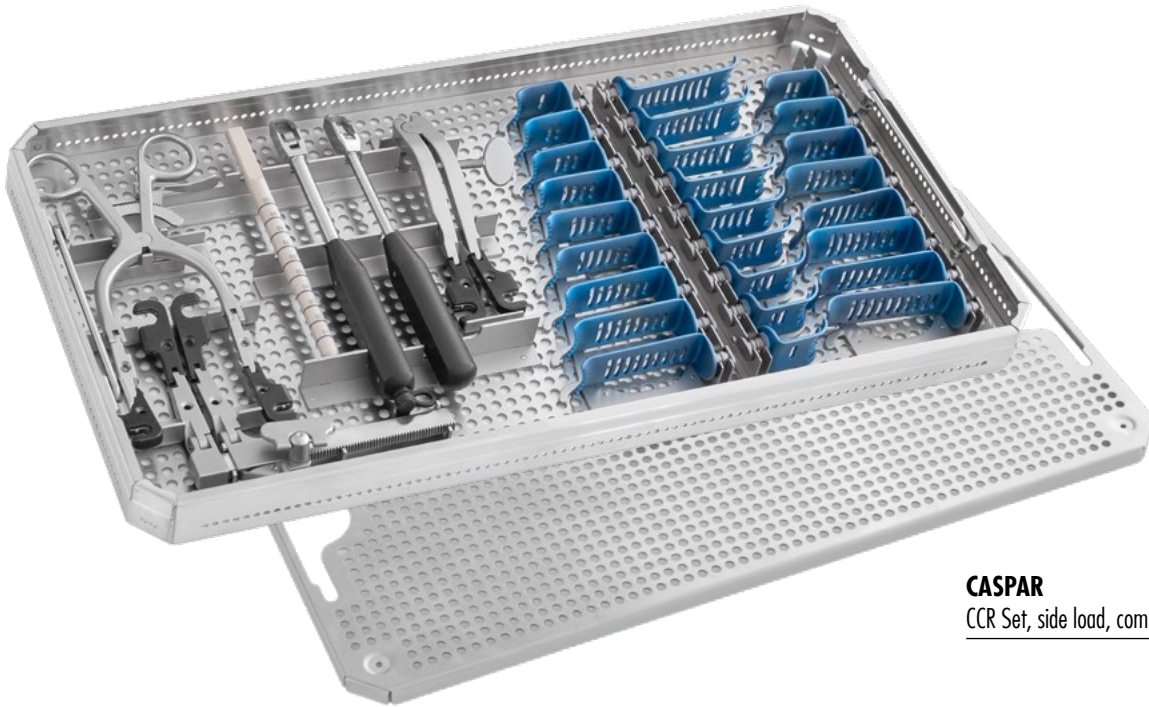

CASPAR

CCR Set, side load, complete

259-180-000

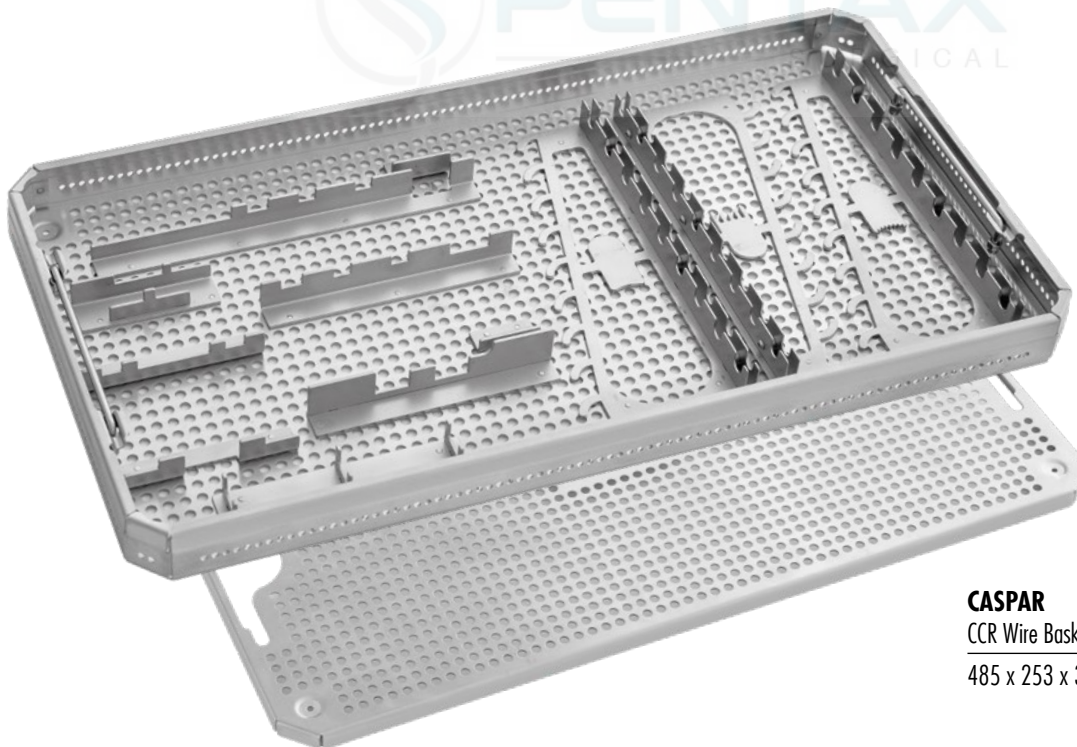

CASPAR

CCR Wire Basket, with lid

485 x 253 x 30mm 259-180-001

RAINBOW CERVICAL RETRACTOR

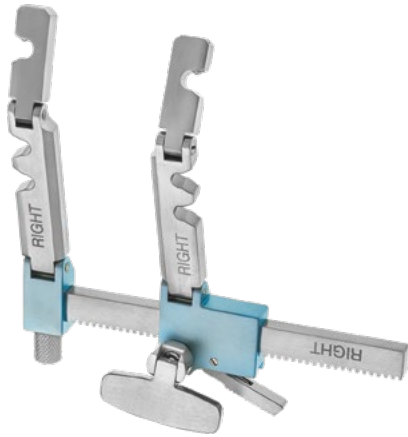

Rainbow Cervical Retractor Frame Right
Max opening: 65mm
Arm length: 80mm

259-188-001



Rainbow Cervical Retractor Frame Left
Max opening: 65mm
Arm length: 80mm

259-188-002

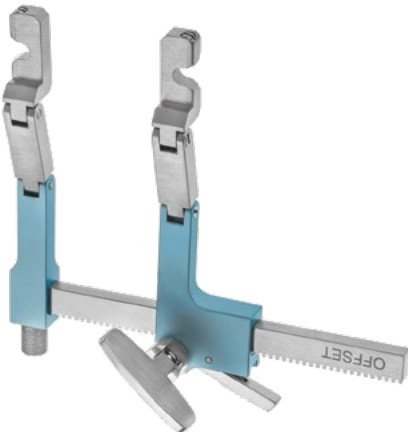

Rainbow Cervical Retractor Offset
Max opening: 80mm
Arm length: 80mm

259-188-003



Rainbow Lumbar Retractor Frame
with instrument coupling
Max opening: 80mm
Arm length: 80mm

259-188-101

RAINBOW CERVICAL RETRACTOR



Rainbow Cervical Toothed Rack
with finger screw

259-188-032



Rainbow Handle

259-188-005

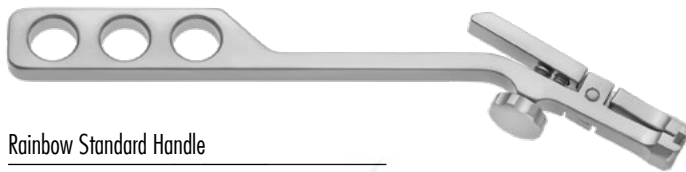

Rainbow Standard Handle

259-188-102



Rainbow Cervical Depth Gauge
with color markings

259-188-102



Rainbow Valve

- | | |
|------------|-------------|
| A Sharp | 259-188-029 |
| B T-Valve | 259-188-030 |
| C Ligament | 259-188-031 |



Rainbow Instrument Coupling

259-188-028

RAINBOW CERVICAL RETRACTOR



Rainbow Valve, 4 prongs

34mm	●	259-188-013
40mm	●	259-188-014
45mm	●	259-188-015
50mm	●	259-188-016
55mm	●	259-188-017
60mm	●	259-188-018
70mm	●	259-188-019
85mm	●	259-188-020



Rainbow Depth Valve, 4 prongs

40mm	●	259-188-007
47mm	●	259-188-008
55mm	●	259-188-009



Rainbow Depth Valve

40mm	●	259-188-010
47mm	●	259-188-011
55mm	●	259-188-012



Rainbow Blunt Valve

34mm	●	259-188-021
40mm	●	259-188-022
45mm	●	259-188-023
50mm	●	259-188-024
55mm	●	259-188-025
60mm	●	259-188-026
70mm	●	259-188-027

RAINBOW CERVICAL RETRACTOR

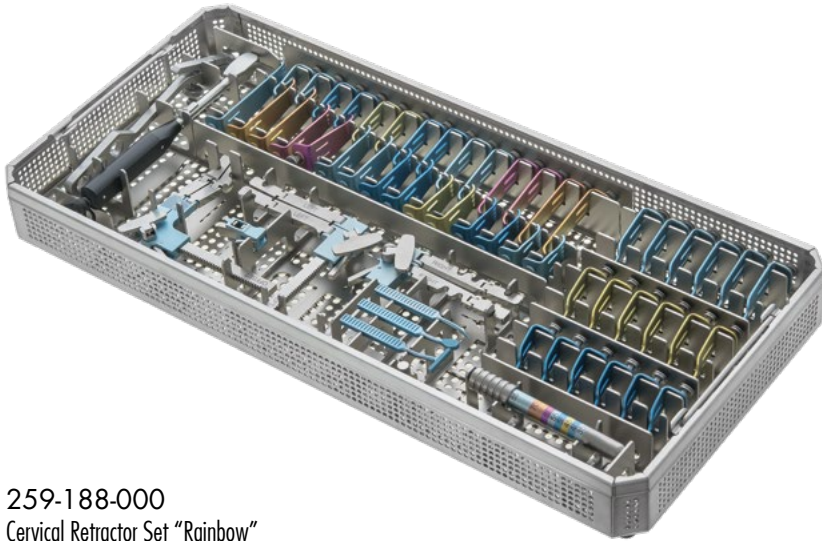

259-188-000
 Cervical Retractor Set "Rainbow"
 consisting of:

1x	259-188-001	2x	●	259-188-012	2x	●	259-188-023
1x	259-188-002	2x	●	259-188-013	2x	●	259-188-024
1x	259-188-003	2x	●	259-188-014	2x	●	259-188-025
1x	259-188-004	2x	●	259-188-015	2x	●	259-188-026
1x	259-188-005	2x	●	259-188-016	2x	●	259-188-027
1x	259-188-102	2x	●	259-188-017	1x		259-188-028
4x ●	259-188-007	2x	●	259-188-018	1x		259-188-029
4x ●	259-188-008	2x	●	259-188-019	1x		259-188-030
4x ●	259-188-009	1x	●	259-188-020	1x		259-188-031
2x ●	259-188-010	2x	●	259-188-021	1x		259-188-032
2x ●	259-188-011	2x	●	259-188-022	1x (Container only)		259-188-033

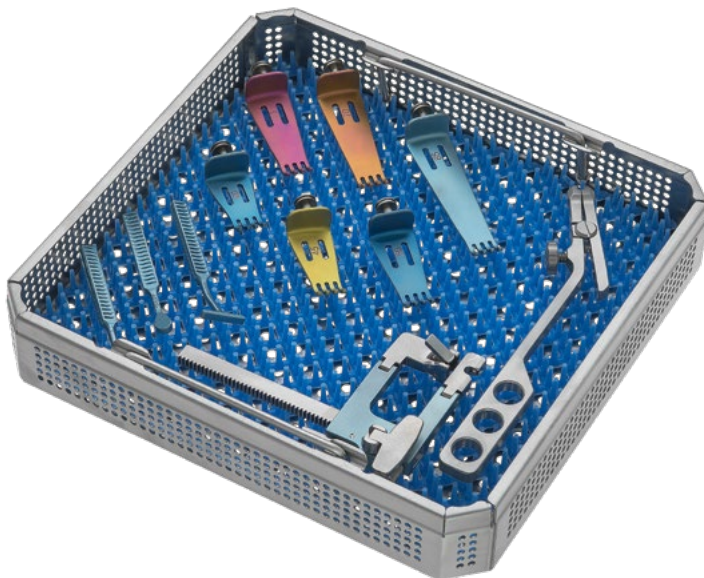

259-188-100
 Lumbar Microdiscectomy Retractor Set
 "Rainbow"
 consisting of:

1x	259-188-101
1x	259-188-102
1x	259-188-029
1x	259-188-030
1x	259-188-031
1x	259-188-014
1x	259-188-015
1x	259-188-016
1x	259-188-018
1x	259-188-019
1x	259-188-020
1x (Container only)	259-188-133

CASPAR LUMBAR RETRACTOR



CLR Retractor side-load

259-190-610



CCR/CLR handle for blades, with black PPSU handle

259-180-100



CCR/CLR handle for blades, cannulated with luer-lock,
with black PPSU handle

259-180-101



CCR/CLR Depth Gauge instrument, natural

259-180-200

CASPAR LUMBAR RETRACTOR



CLR Blade, side load, width: 20mm,
color: blue, 3 prongs

20 x 35mm	259-190-235
20 x 40mm	259-190-240
20 x 45mm	259-190-245
20 x 55mm	259-190-255
20 x 65mm	259-190-265



CLR Blade, side load, width: 40mm,
color: blue, 3 prongs

40 x 35mm	259-190-435
40 x 40mm	259-190-440
40 x 45mm	259-190-445
40 x 55mm	259-190-455
40 x 65mm	259-190-465
40 x 75mm	259-190-475



CLR Blade, side load, width: 60mm,
color: blue, 3 prongs

60 x 35mm	259-190-635
60 x 40mm	259-190-640
60 x 45mm	259-190-645
60 x 55mm	259-190-655
60 x 65mm	259-190-665
60 x 75mm	259-190-675
60 x 85mm	259-190-685



Hemi-laminectomy hook, color: blue

small	259-190-231
large	259-190-232

CASPAR LUMBAR RETRACTOR

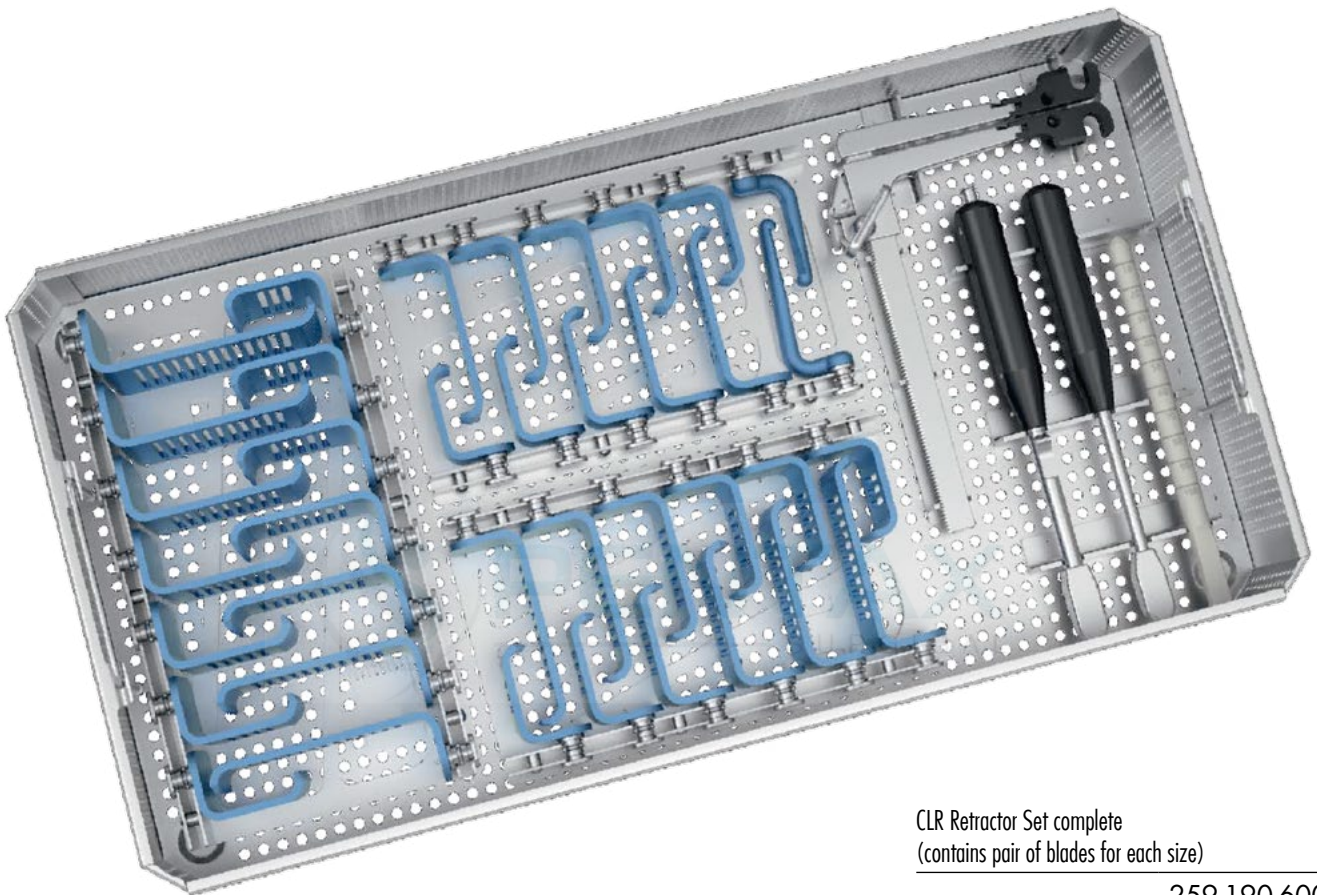

CLR Retractor Set complete
(contains pair of blades for each size)

259-190-600

CASPAR LUMBAR RETRACTOR

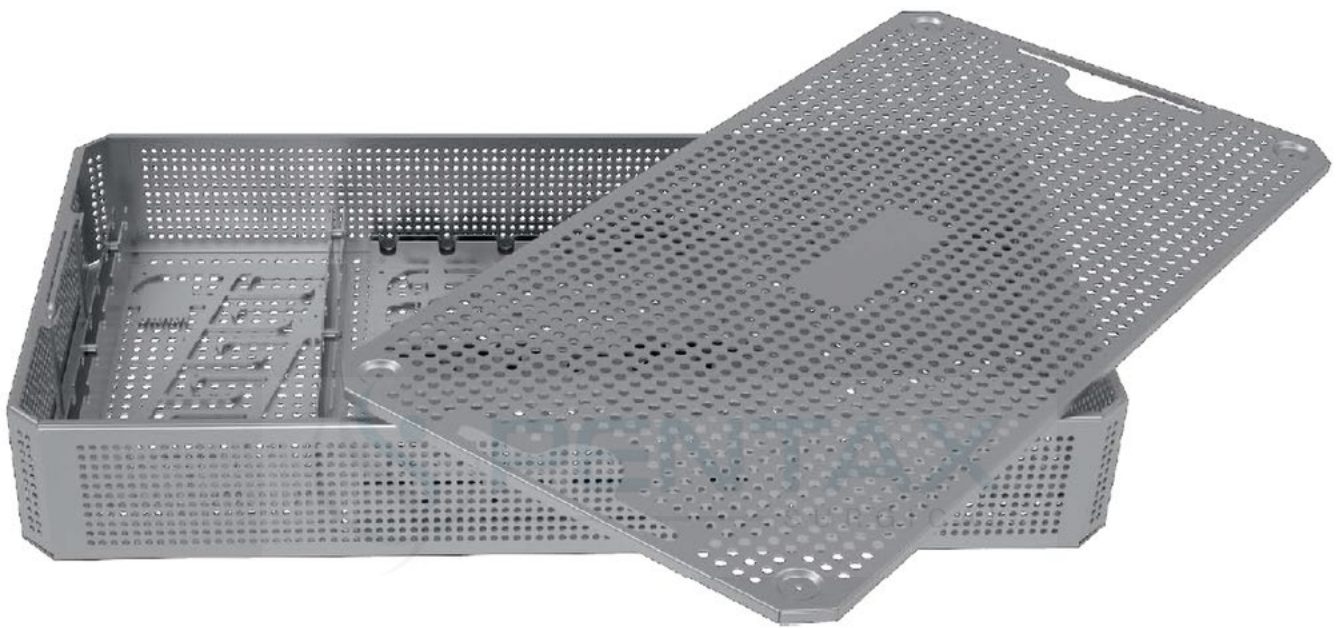

CLR Retractor Set Tray empty

259-190-601

BUTTERFLY SPINE RETRACTOR SET

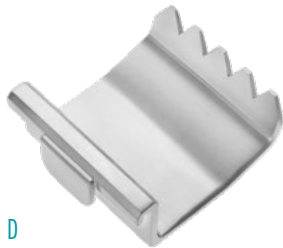
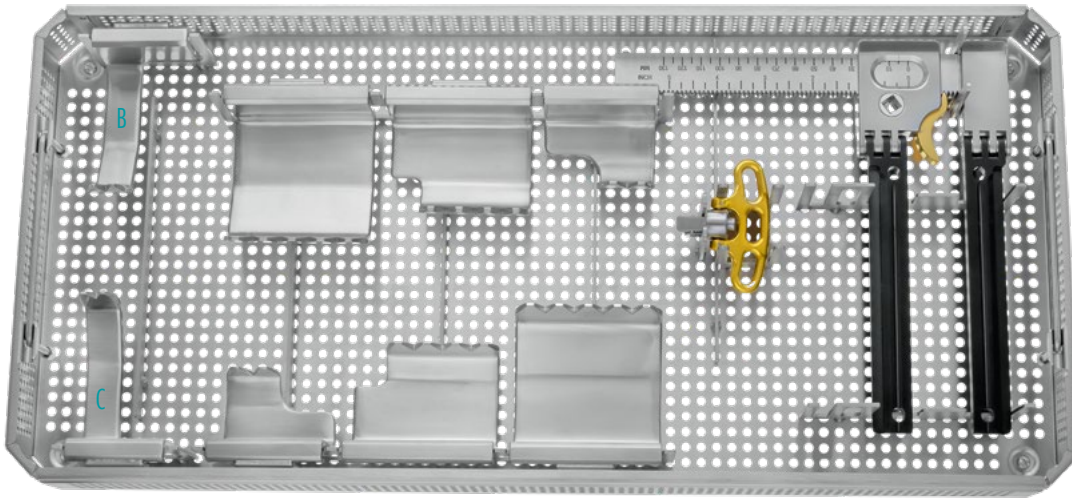

Lightweight, new designed set

with tray — 290-300-340

without tray 290-300-330

B + C optional, not included in the set

Set consists of

Type	Width	Length	Quantity	
A Retractor			1	290-300-311
D Retractor 5 teeth	76mm	64mm	2	290-300-312
E Retractor left	31mm	38mm	1	290-300-313
E Retractor right	31mm	38mm	1	290-300-314
F Retractor left	57mm	44mm	1	290-300-315
F Retractor right	57mm	44mm	1	290-300-316

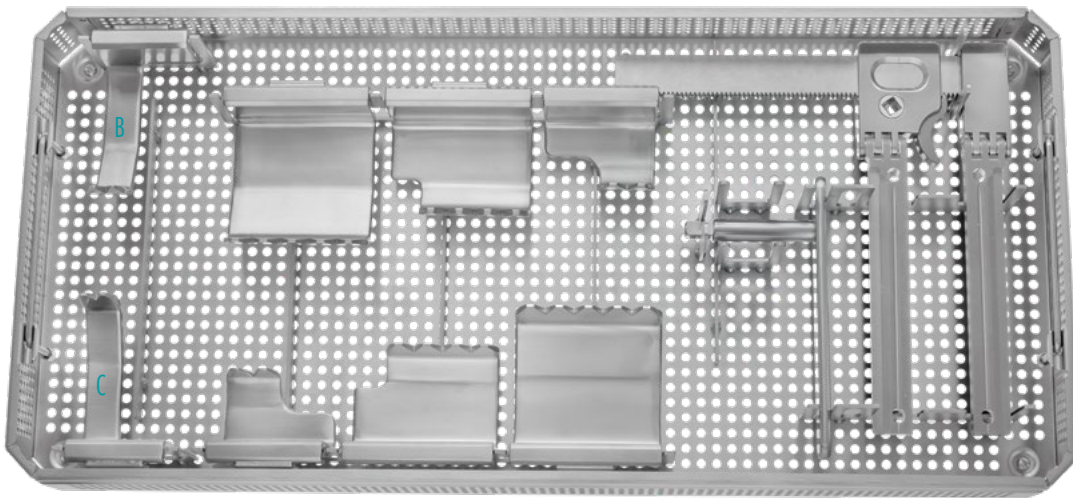
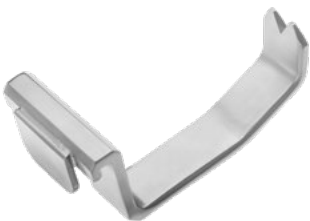
G

Standard Butterfly Set

with tray and lid 290-300-320

without tray and lid 290-300-310

B + C optional, not included in the set

Set consists of

Type	Width	Length	Quantity	
G Standard Retractor			1	290-300-301
D Retractor 5 teeth	76mm	64mm	2	290-300-302
E Retractor left	31mm	38mm	1	290-300-303
E Retractor right	31mm	38mm	1	290-300-304
F Retractor left	57mm	44mm	1	290-300-305
F Retractor right	57mm	44mm	1	290-300-306

Optional Retractors, right/left angled (standard), for B + C

Width	Length	Quantity	
19mm	31mm	2	290-300-205
19mm	44mm	2	290-300-206
19mm	57mm	2	290-300-207
19mm	83mm	2	290-300-209
19mm	76mm	2	290-300-208
19mm	102mm	2	290-300-210
51mm	102mm	2	290-300-216 (not offset)

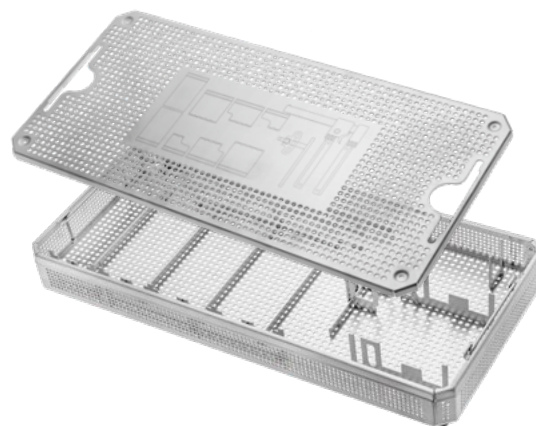

Tray with lid (fits for standard and lightweight)

290-300-350

LT - SET FOR LUMBAR RETRACTION



LT Lumbar Retraction Set, complete with tray
259-197-000

Tray only
540x253x170mm 259-197-001

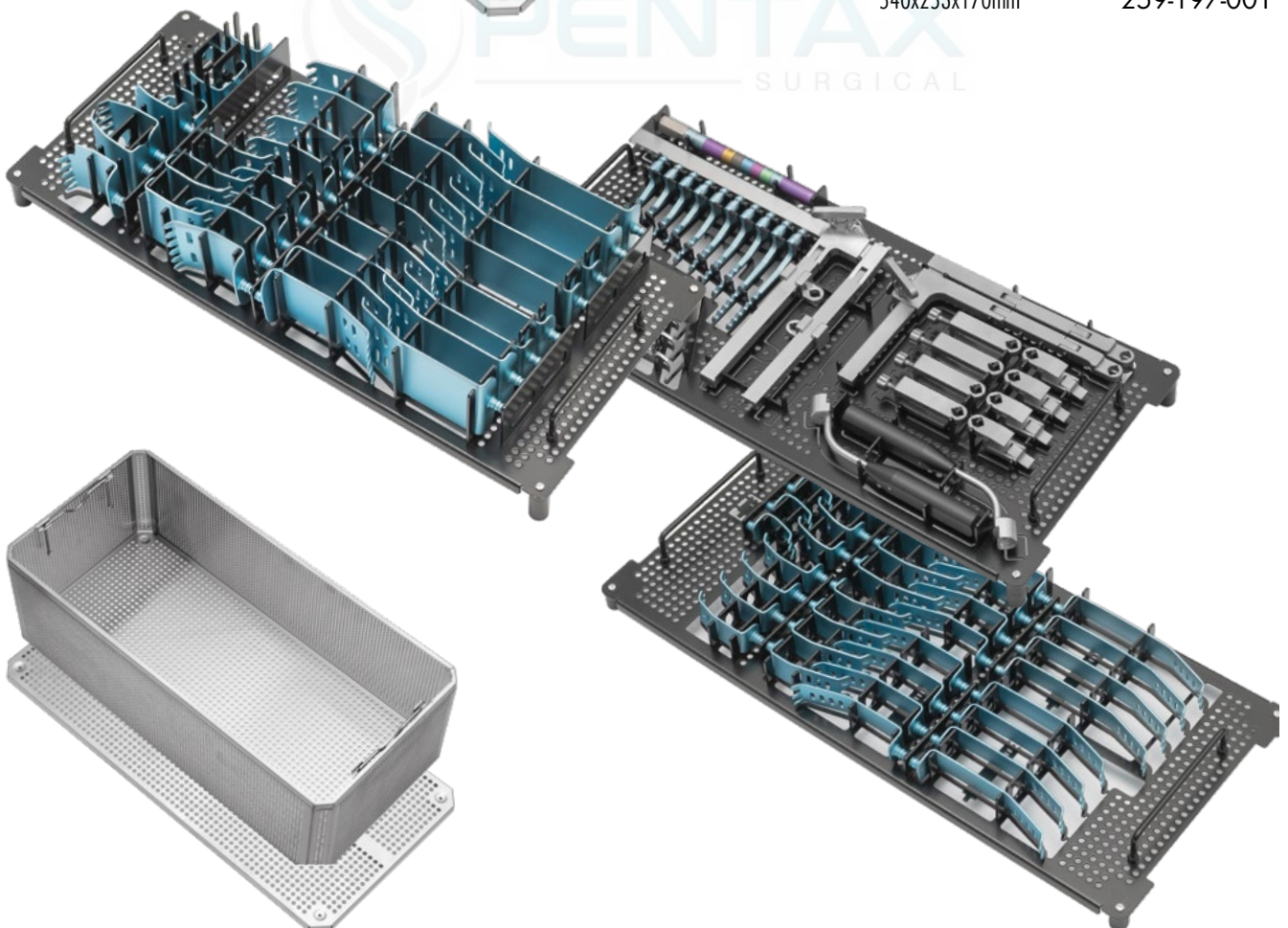

LT - SET FOR LUMBAR RETRACTION

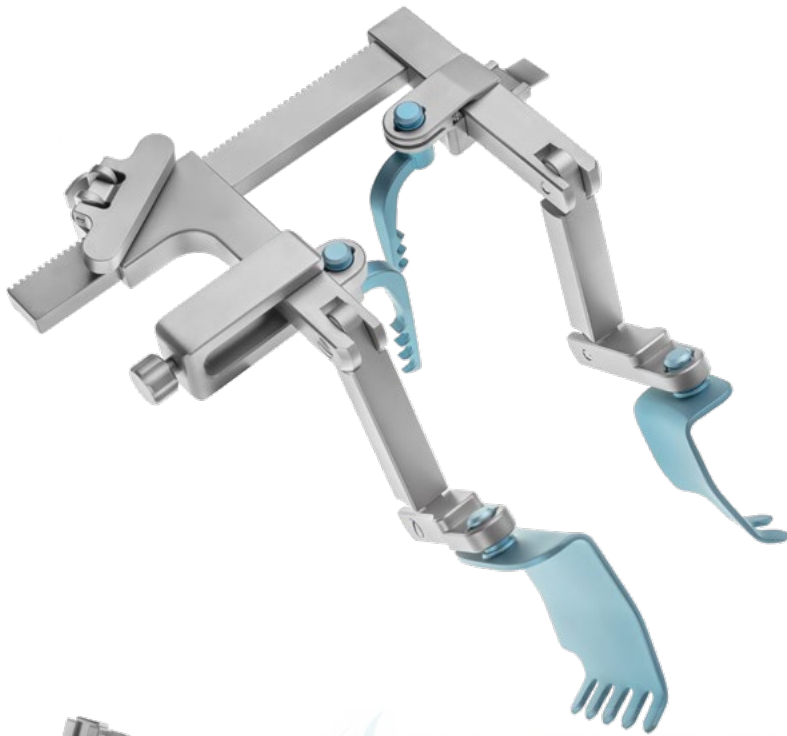

LT Retractor, hinged

209mm spread

259-197-002

LT Retractor, double hinged

102mm spread

259-197-003

209mm spread

259-197-004

LT - SET FOR LUMBAR RETRACTION



Blade connector with quick coupling

259-197-005



Blade connector with screw connection

259-197-006

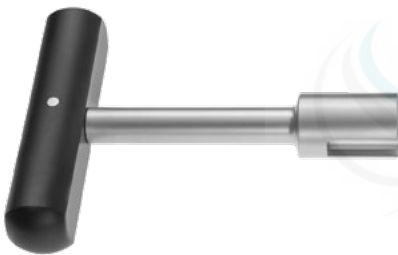

T-Handle

259-197-007



Handle, manual blade retraction

259-197-009



Depth Gauge

259-197-008

LT - SET FOR LUMBAR RETRACTION



LT Valve, 6 prongs, 60mm wide

50mm depth	259-197-650
60mm depth	259-197-660
70mm depth	259-197-670
80mm depth	259-197-680
90mm depth	259-197-690
110mm depth	259-197-691
130mm depth	259-197-693



LT Hook, toothed

34mm depth, 3 teeth	259-197-103
44mm depth, 4 teeth	259-197-104
54mm depth, 5 teeth	259-197-105
64mm depth, 6 teeth	259-197-106
84mm depth, 7 teeth	259-197-107



LT Valve, left, 2 prongs

30mm width, 40mm depth	259-197-111
60mm width, 45mm depth	259-197-112

right, 5 prongs

30mm width, 40mm depth	259-197-113
60mm width, 45mm depth	259-197-114

LT - SET FOR LUMBAR RETRACTION



LT Valve, 3 prongs, 24mm wide

30mm depth	259-197-330
40mm depth	259-197-340
50mm depth	259-197-350
60mm depth	259-197-360
70mm depth	259-197-370
80mm depth	259-197-380
90mm depth	259-197-390
110mm depth	259-197-410
130mm depth	259-197-430



LT Valve, 5 prongs, 45mm wide

50mm depth	259-197-550
60mm depth	259-197-560
70mm depth	259-197-570
80mm depth	259-197-580
90mm depth	259-197-590
110mm depth	259-197-591
130mm depth	259-197-593



LT T-Valve, 25mm wide

40mm depth	259-197-254
50mm depth	259-197-255
60mm depth	259-197-256
70mm depth	259-197-257

CASPAR MICRO DISCECTOMY RETRACTOR



CASPAR

Counter Retractor, hinged arms

259-185-100

CASPAR

Specula

40mm	259-185-040
45mm	259-185-045
50mm	259-185-050
55mm	259-185-055
60mm	259-185-060
65mm	259-185-065
75mm	259-185-070
80mm	259-185-080
85mm	259-185-085

CASPAR MICRO DISCECTOMY RETRACTOR



Lateral blade with snap lock

35mm	259-185-235
40mm	259-185-240
45mm	259-185-245
50mm	259-185-250
55mm	259-185-255
60mm	259-185-260
65mm	259-185-265
75mm	259-185-275
80mm	259-185-280
85mm	259-185-285



Medial blade

40mm	259-185-340
45mm	259-185-345
50mm	259-185-350
55mm	259-185-355
60mm	259-185-360
65mm	259-185-365
70mm	259-185-370



Blade Ejector Forceps

115mm, 4 ¹ / ₂ "	259-185-101
--	-------------

MCCULLOCH MICRO DISCECTOMY RETRACTOR



MCCULLOCH

Retractor Frame, with hinged arms

85mm, 3"

259-170-200

with rigid arms

85mm, 3"

259-170-100



MCCULLOCH MICRO DISCECTOMY RETRACTOR

MCCULLOCH

Muscle blade, 27mm wide, 6 teeth

30mm, 1 ¹ / ₅ "	259-170-130
40mm, 1 ² / ₃ "	259-170-140
50mm, 2"	259-170-150
60mm, 2 ¹ / ₃ "	259-170-160
70mm, 2 ⁴ / ₅ "	259-170-170
80mm, 3 ¹ / ₅ "	259-170-180
90mm, 3 ¹ / ₂ "	259-170-190

Blade Set, large

Set with 12 pcs. (2 blades each) 259-170-130 to 259-170-180	259-170-110
--	-------------

Blade Set, small

Set with 8 pcs. (2 blades each) 259-170-140 to 259-170-170	259-170-111
---	-------------

MCCULLOCH

Muscle blade, 20mm wide, 4 teeth

30mm, 1 ¹ / ₅ "	259-170-230
40mm, 1 ² / ₃ "	259-170-240
50mm, 2"	259-170-250
60mm, 2 ¹ / ₃ "	259-170-260
70mm, 2 ⁴ / ₅ "	259-170-270
80mm, 3 ¹ / ₅ "	259-170-280

Blade Set, large

Set with 12 pcs. (2 blades each) 259-170-230 to 259-170-280	259-170-210
--	-------------

Blade Set, small

Set with 8 pcs. (2 blades each) 259-170-240 to 259-170-270	259-170-211
---	-------------

MCCULLOCH

Muscle blade, 17mm wide, 2 teeth

30mm, 1 ¹ / ₅ "	259-170-330
40mm, 1 ² / ₃ "	259-170-340
50mm, 2"	259-170-350
60mm, 2 ¹ / ₃ "	259-170-360
70mm, 2 ⁴ / ₅ "	259-170-370
80mm, 3 ¹ / ₅ "	259-170-380
90mm, 3 ¹ / ₂ "	259-170-390

Blade Set, large

Set with 12 pcs. (2 blades each) 259-170-330 to 259-170-380	259-170-310
--	-------------

Blade Set, small

Set with 8 pcs. (2 blades each) 259-170-340 to 259-170-370	259-170-311
---	-------------

MCCULLOCH MICRO DISCECTOMY RETRACTOR

MCCULLOCH

Cervical blade, 20mm wide, 2 teeth

50mm, 2"	259-170-650
60mm, 2 ¹ / ₃ "	259-170-660
70mm, 2 ⁴ / ₅ "	259-170-670

MCCULLOCH

Hook #1

20mm, 4/5"	259-170-420
30mm, 1 ¹ / ₅ "	259-170-430
40mm, 1 ² / ₃ "	259-170-440
50mm, 2"	259-170-450
60mm, 2 ¹ / ₃ "	259-170-460
70mm, 2 ⁴ / ₅ "	259-170-470
80mm, 3 ¹ / ₅ "	259-170-480

Blade Set, large

Set with 12 pcs. (2 blades each) 259-170-420 to 259-170-470	259-170-410
--	-------------

Blade Set, small

Set with 8 pcs. (2 blades each) 259-170-430 to 259-170-460	259-170-411
---	-------------

MCCULLOCH

Hook #2

20mm, 4/5"	259-170-520
30mm, 1 ¹ / ₅ "	259-170-530
40mm, 1 ² / ₃ "	259-170-540
50mm, 2"	259-170-550
60mm, 2 ¹ / ₃ "	259-170-560
70mm, 2 ⁴ / ₅ "	259-170-570
80mm, 3 ¹ / ₅ "	259-170-580

Blade Set, large

Set with 12 pcs. (2 blades each) 259-170-520 to 259-170-570	259-170-510
--	-------------

Blade Set, small

Set with 8 pcs. (2 blades each) 259-170-530 to 259-170-560	259-170-511
---	-------------

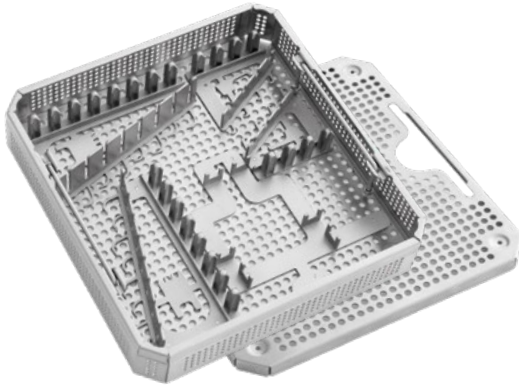

MCCULLOCH

Tray, small, with lid

253 x 253 x 50mm 259-170-000

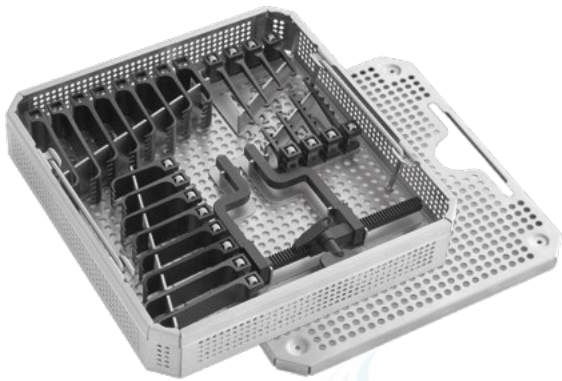

MCCULLOCH

Set with Tray, small 259-170-000
and hinged retractors,
blades 2 each, 1 hook each

259-170-001

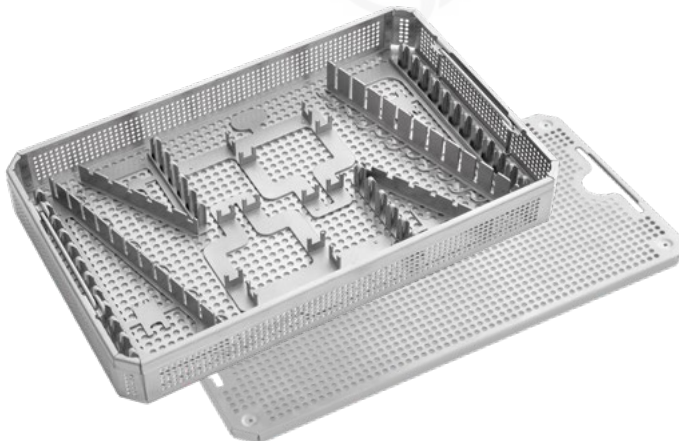

MCCULLOCH

Tray, large, with lid

405 x 253 x 50mm 259-170-002

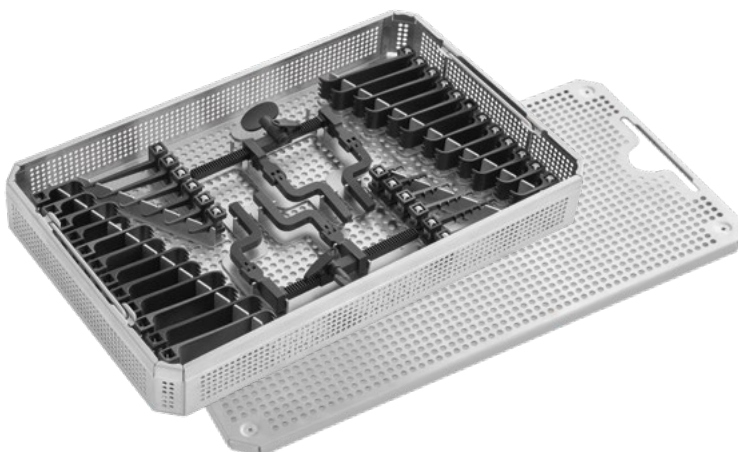

MCCULLOCH

Set with Tray, large 259-170-002
and hinged retractors,
blades 2 each, 1 hook each

259-170-003

MCCULLOCH MICRO DISCECTOMY RETRACTOR

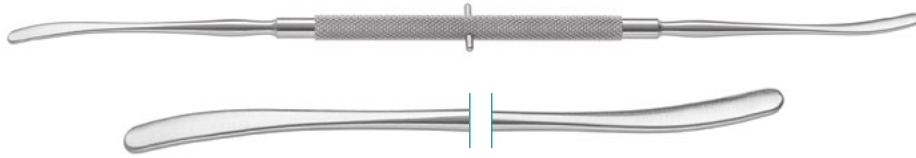

Double Ended Elevator
230mm, 9" 259-160-042



Osteotome, 215mm, 8^{1/2}"
4mm wide 259-210-004
6mm wide 259-210-006



Hockey-Stick Chisel, 215mm, 8^{1/2}"
left curved 259-210-005
right curved 259-211-005

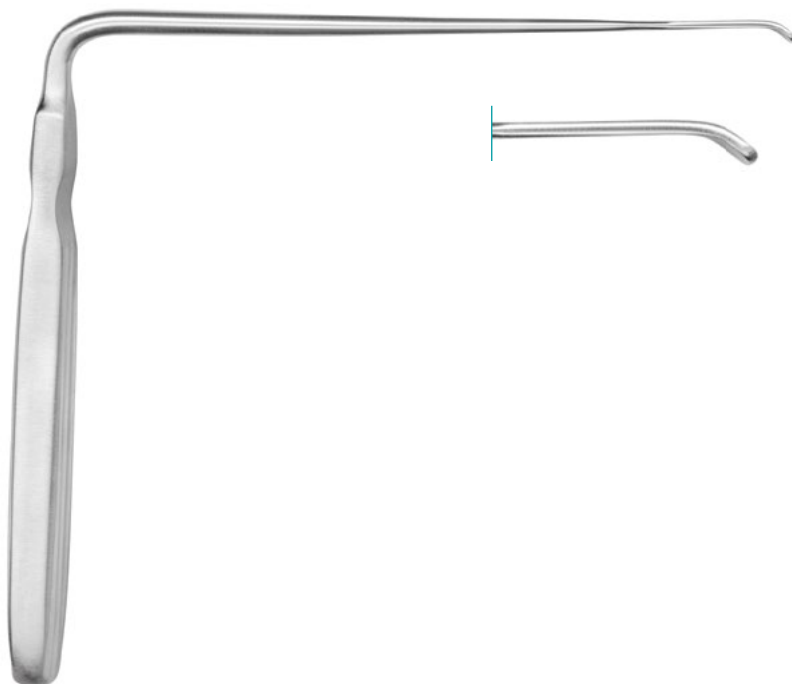

Nerve Root Retractor, 90° angled shaft
6mm wide tip 259-160-006

MCCULLOCH MICRO DISCECTOMY RETRACTOR

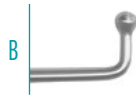

Ball Probe, 235mm, 9¹/₄"

A 4mm tip 259-230-004

B 7mm tip 259-230-007

Manipulation Hook, 235mm, 9¹/₄"

C 4mm tip 259-230-104



Spinal Elevator, semi-sharp, 290mm, 11¹/₂"

12mm wide tip 259-440-100

19mm wide tip 259-450-100

CASPAR WOUND RETRACTOR



CASPAR

Retractor with key

259-185-449



CASPAR

Hook

38mm

259-185-435

58mm

259-185-437



CASPAR

Blade, 2 prongs

32x22mm

259-185-442

52x22mm

259-185-445

62x22mm

259-185-447



CASPAR

Blade, 3 prongs

37x37mm

259-185-452

62x37mm

259-185-457



CASPAR

Blade, 4 prongs

37x52mm

259-185-462

67x52mm

259-185-467



HUDSON

Hand Drill, complete with 4 burrs and extension
(Hudson tightening screw)

270mm, 10^{2/3}" 200-152-000

Hand Drill only with clamping screw

200-150-000

Hand Drill only with Hudson snap lock

200-151-000

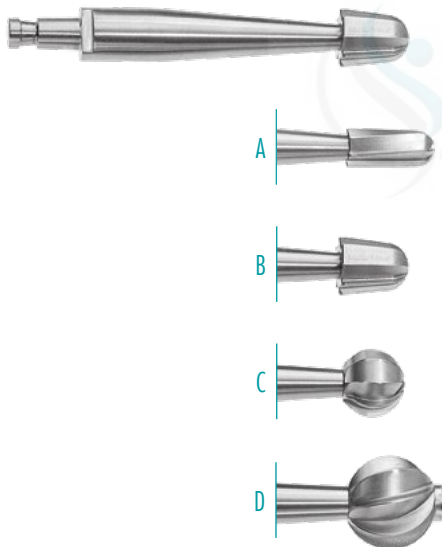

PENTAX
SURGICAL

Burrs, 60mm length

A Ø 9mm 200-152-001

B Ø 14mm 200-152-002

C Ø 16mm 200-152-003

D Ø 22mm 200-152-004



Extension piece

200-152-009



RANEY

Scalp Haemostasis Clip, 10 pcs. per package

250-066-001

black

250-066-002



RANEY

Applying and Removing Forceps
for 250-066-001

160mm, 6¹/₄"

250-066-003



YASARGIL

Suction Cannula, Ø 1.5mm

130mm, 5 ¹ / ₈ "	250-064-152
150mm, 6"	250-064-154
180mm, 7"	250-064-156
220mm, 8 ² / ₃ "	250-064-158

Ø 2.0mm

130mm, 5 ¹ / ₈ "	250-064-162
150mm, 6"	250-064-164
180mm, 7"	250-064-166
220mm, 8 ² / ₃ "	250-064-168

Ø 2.5mm

130mm, 5 ¹ / ₈ "	250-064-172
150mm, 6"	250-064-174
180mm, 7"	250-064-176
220mm, 8 ² / ₃ "	250-064-178

Ø 3.5mm

130mm, 5 ¹ / ₈ "	250-064-182
150mm, 6"	250-064-184
180mm, 7"	250-064-186
220mm, 8 ² / ₃ "	250-064-188

Ø 4.5mm

180mm, 7"	250-064-189
-----------	-------------



FUKUSHIMA

Suction tube, conical, malleable, 165mm, 6^{1/2}"

3 Charr.	165-533-163
4 Charr.	165-533-164
5 Charr.	165-533-165
6 Charr.	165-533-166



FUKUSHIMA

Suction tube, conical, malleable, 180mm, 7"

3 Charr.	165-533-183
4 Charr.	165-533-184
5 Charr.	165-533-185
6 Charr.	165-533-186
7 Charr.	165-533-187
8 Charr.	165-533-188
9 Charr.	165-533-189

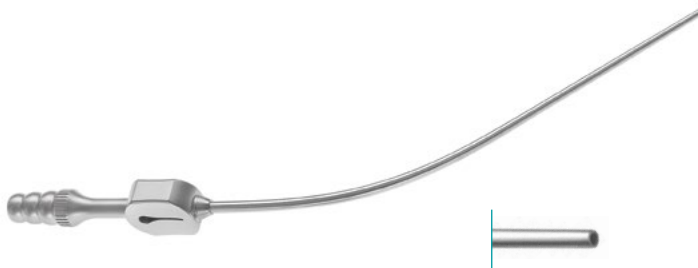

FUKUSHIMA

Suction tube, conical, malleable, 205mm, 8^{1/8}"

3 Charr.	165-533-203
4 Charr.	165-533-204
5 Charr.	165-533-205
6 Charr.	165-533-206
7 Charr.	165-533-207
8 Charr.	165-533-208
9 Charr.	165-533-209
10 Charr.	165-533-210
12 Charr.	165-533-212

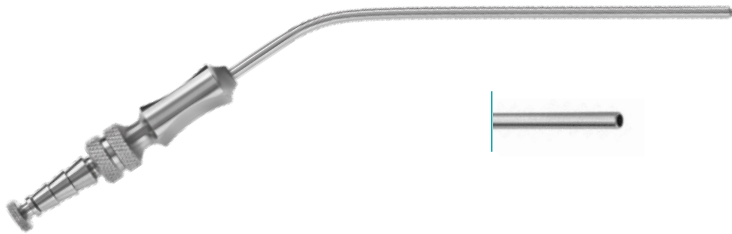

FRAZIER

Suction tube, 30° angled,
190mm, 7¹/₂" overall length

5 Charr.	165-523-005
6 Charr.	165-523-006
7 Charr.	165-523-007
8 Charr.	165-523-008
9 Charr.	165-523-009
10 Charr.	165-523-010
11 Charr.	165-523-011
12 Charr.	165-523-012
15 Charr.	165-523-015



FRAZIER

Suction tube, straight,
130mm, 5¹/₈" working length

6 Charr.	165-522-106
8 Charr.	165-522-108
10 Charr.	165-522-110
12 Charr.	165-522-112



BARON

Suction tube, finger cut-off, stylet, 100mm, 4"

3 Charr.	165-539-003
5 Charr.	165-539-005
7 Charr.	165-539-007



ADSON

Suction tube, Ø 4mm, 210mm, 8¹/₄"

12 Charr.	165-521-004
-----------	-------------



TAYLOR

Percussion Mallet

170mm, 6²/₃" 100-111-170

200mm, 8" 100-111-200

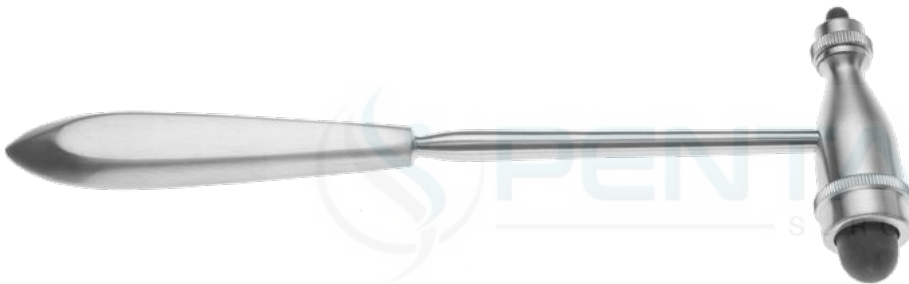

TROEMNER

Percussion Mallet

240mm, 9¹/₂" 100-113-240



DERJERINE

Percussion Mallet with needle

200mm, 8" 100-115-200

THANK YOU



CONTACT US



www.pentaxsurgical.com



pentaxsurgical@gmail.com
info@pentaxsurgical.com



+92-328 01 66 200

Visit Alibaba Site:

