

Manufacturer Of all kind of Dental Instruments



PRODUCT CATALOG

DENTAL INSTRUMENTS



Visit Alibaba Site:



COMPANY PROFILE

ABOUT US

WELCOME TO PENTAX SURGICAL

Established in 2008, PENTAX SURGICAL is on a mission to redefine the industry by proving that quality doesn't have to be sacrificed for competitiveness. Our commitment revolves around producing high-quality instruments at prices that keep you smiling. From our humble beginnings as a family-run veriore, we've evolved into a significant player in the market.

Our mission is clear to instill confidence in our clients by delivering Instruments of the highest quality at prices that make sense. We understand that the key to succes lies in customer satisfaction and loyalty, which forms the core of our vision. As we grow, our focus reamins on fostering strong relatoriships with our customers

At PENTAX SURGICAL, we firmly believe that quality is never accidental, it's the outcome of thoughtful and intelligent effort Each instrument we produce reflects this commitment to excellence, ensuring you receive products that exceed expectations. Join us on our journey as we continue to set new standards in quality and customer satisfaction.

Contents

Trocars	03-2
Suction Tubes	03-4
Scalpel Handles	04-2
Gum Knives	04-5
Operating Scissors	05-2
Dissecting Scissors	05-3
Dissecting Scissors, Fine – Line	05-6
Fine Operating Scissors	05-7
Tonsil and Nasal Scissors	05-8
Gum Scissors	05-9
Fine Operating Scissors	05-11
Wire Cutting and Crown Scissors	05-12
Micro Scissors	05-13
Scissors with Tungsten Carbide Inserts	05-14
Dressing Forceps	06-2
Tissue Forceps	06-5
Splinter Forceps	06-7
Dissecting Forceps with Tungsten Carbide Inserts	06-8
Artery Forceps	07-2
Artery Forceps Dissecting and Ligature Forceps	07-4
Towel Forceps	07-5
Polypus and Dressing Forceps Sponge Holding Forceps	08-2
Retractors	09-2
Retractor Abdominal Spatulas	09-10
Probes	10-2
Cotton Applicators	10-3
Needle Holders	11-2
Micro Needle Holders with Tungsten Carbide Inserts	11-6
Needle Holders with Tungsten Carbide Inserts	11-7
Bone Chisels and Gouges	13-2
Mallets	13-5
Bone Curettes	13-7
Periosteal Raspatories	13-12
Rasps Tampers	13-13
Elevators	13-14
Bone Rongeur Forceps	13-15
Bone Cutting Forceps	13-20
Dura Hooks	15-2
Hooklets, Trephines	17-2
Tissue Organ Holding Forceps	18-2
Nasal Rasps	23-2
Mouth Gags	24-2
Cheek – Lip Retractors	24-7
Cheek and Lip Retractors Tongue Depressors	24-8

Tongue Depressors	24-10
Tongue Depressors with Cotton Roll Holders	24-12
Minnesota Retractors	24-13
Tongue Holding Forceps	24-14
Soft Tissue Retractors	24-15
Packers	25-2
Hooks	26-2
Lachrymal Dilators and Probes	27-2
Nail Scissors, Nail Nippers	29-2
Cuticle Nippers, Cuticle Scissors, Nail Files	29-3
Nail Nippers	29-4
Brush and Towel Baskets, Soap Dishes	29-5
Sterilizing Forceps	29-6
Sterilizing Cases	29-9
Needle Sterilizing Cases	29-10
Sterilizing and Storing Cases	29-13
Sterile Deposit System	29-15
Safety Pins	29-17
Sterilizing Trays	29-18
Sterilizing Baskets	29-19
Solution Bowls, Wash Bowls	29-20
Round Bowls, Graduated Measures	29-21
Universal Trays, Instrument Storing Trays	29-22
Trays and Jars	29-23
Instrument Boxes	29-24
Containers for Cotton Wool, Pellets	29-25
Medicine Cups and Spoons, Petri Dishes	29-26
Container for Dentures, Sputum Cups	29-27
Kidney Bowls, Bed Pans	29-28
Triangular Basin, Placenta Pan	29-29
Gauze and Cotton Dispenser, Powder Strewer	29-30
Cotton Receptacles	29-31
Alcohol Burners	29-32
Crucible Tongs	29-33
Spatulas	29-34
Spring Calipers, Micrometers	29-36
Waste Buckets, Waste Forceps	29-37
Extracting Forceps, English Pattern	60-2
Extracting Forceps	60-12
Extracting Forceps Mead Patterns	60-14
Extracting Forceps for Children, English Pattern	60-15
Extracting Forceps for Children, with spring, Klein Pattern	60-17
Extracting Forceps for Children, American Pattern	60-18
Extracting Forceps American Pattern	60-19
Root Fragment Forceps	60-31
Root Elevators	61-2

Cartridge Syringes, Hypoeremic Needles	61-11
Water Syringes, Chip Blowers	61-12
Mouth Mirrors	61-13
Cheek Holder	61-14
Handles for Mouth Mirrors	61-15
Cotton and Dressing Tweezers (Pliers)	62-2
Scalers	62-4
Files	62-8
Periodontia Instruments	62-9
Probes and Explorers	62-20
Excavators	62-22
Cutting Instruments	62-27
Nerve Instruments	62-28
Instruments for Amalgam	63-2
Amalgam Instruments, Finger Cups	63-5
Burnishers	63-6
Plastic Filling Instruments	63-7
Cement Spatulas	63-13
Cement Spatulas, Silicate Spatulas	63-14
Matrix Retainers, Matrix Bands	63-15
Rubber Dam Instruments	63-18
Impressing Tray	64-2
Impressing Tray for Partial Impressing	64-6
Spatulas, Mixing Bowls	64-7
Wax Instruments	64-8
Wax, Porcelain and Modelling Carvers	64-9
Instruments for Crown Work	64-13
Riveting Hammers, Horn and Flask Mallets	65-2
Flat Nose Pliers	65-3
End and Side Nippers, Bar Bending Pliers	65-4
Wire, Arch and Clasp Bending Pliers	65-5
Universal Pliers	65-6
Copper Ring and Bridge Removing Pliers	65-7
Crown Pliers, Contouring Pliers	65-8

03

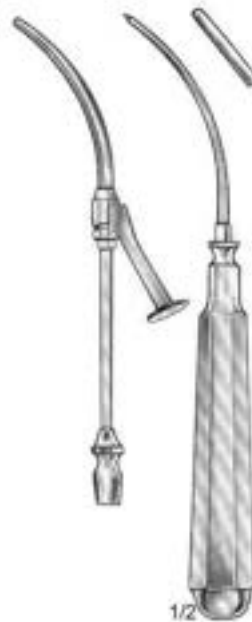




Lichtwitz
 03-144-16
 Ø 1.6 mm



Pierce
 03-148-30 Ø 3 mm
 03-148-40 Ø 4 mm
 03-148-50 Ø 5 mm



Coakley
 03-152-16
 Ø 2.25 mm



Ruskin
 03-156-20 - 03-157-20
 Ø 2 mm



Adson
 03-170-21
 21 cm
 Ø 4 mm



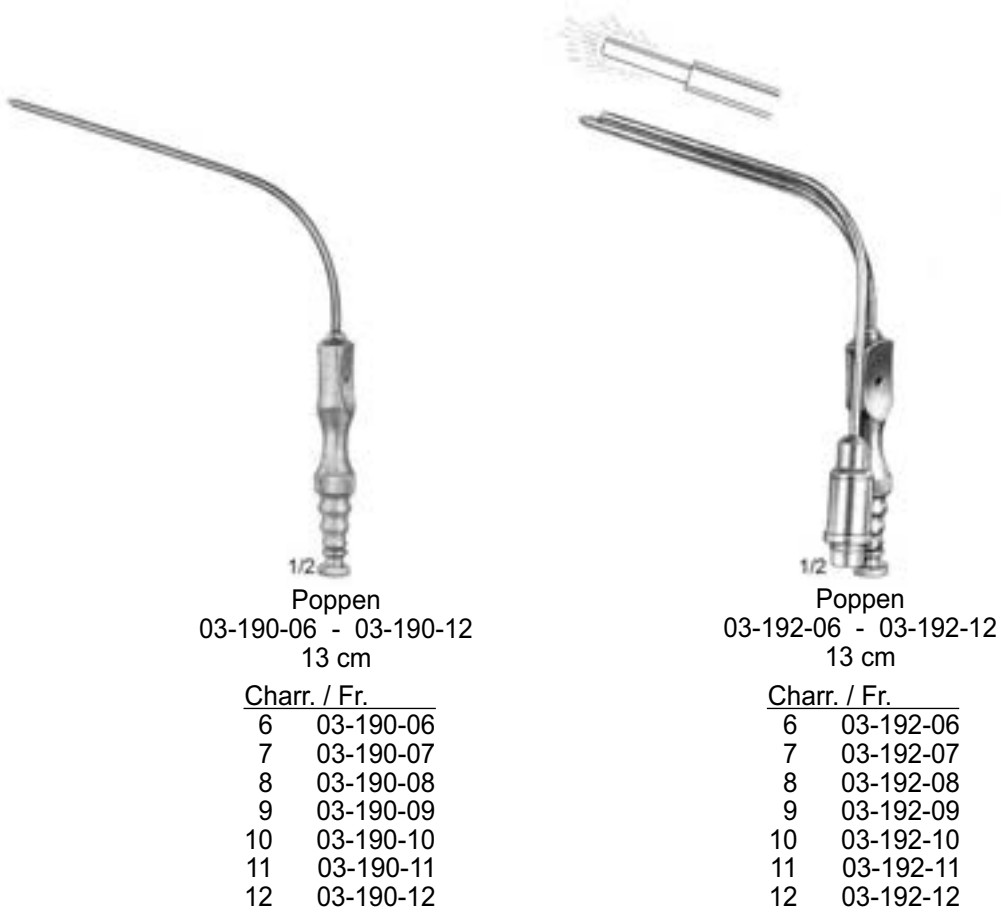
Frazier
 03-180-06 - 03-180-12
 19 cm

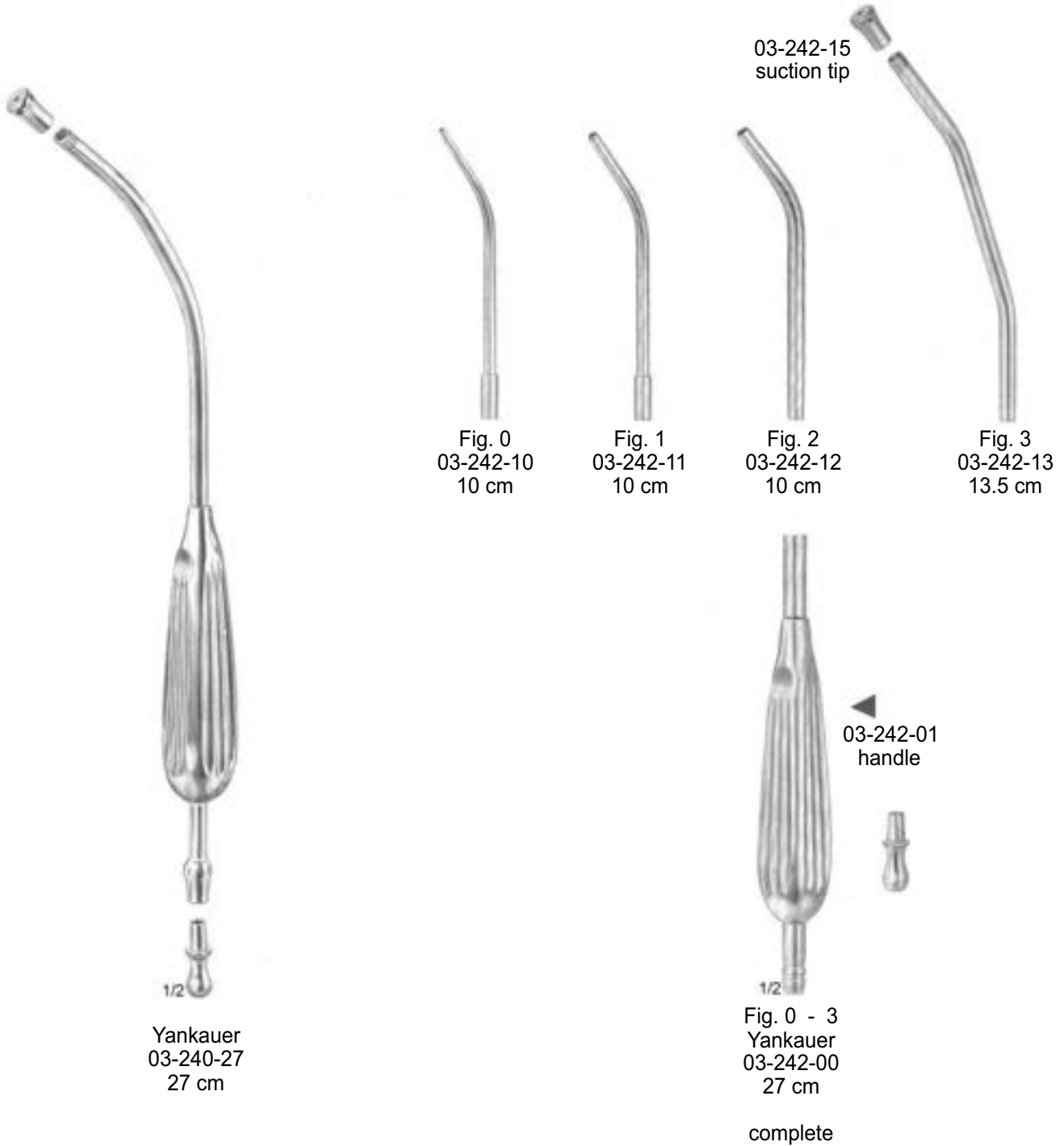
Charr. / Fr.	
6	03-180-06
7	03-180-07
8	03-180-08
9	03-180-09
10	03-180-10
11	03-180-11
12	03-180-12



Frazier
 03-182-06 - 03-182-12
 19 cm

Charr. / Fr.	
6	03-182-06
7	03-182-07
8	03-182-08
9	03-182-09
10	03-182-10
11	03-182-11
12	03-182-12





6 mm
round



6 mm
oval



Nuboer
03-290-21
21 cm



Nuboer
03-292-21
21 cm

- 03-300-01
Ø 1.5 mm
- 03-300-02
Ø 2.5 mm
- 03-300-03
Ø 3.5 mm



Byrd
03-300-01 - 03-300-03
20cm



- 03-320-01
Ø 1.5 mm
- 03-320-02
Ø 2.0 mm
- 03-320-03
Ø 2.5 mm
- 03-320-04
Ø 3.5 mm

9 cm

with additional side holes



- 03-320-05
Ø 1.5 mm
- 03-320-06
Ø 2.0 mm
- 03-320-07
Ø 2.5 mm
- 03-320-08
Ø 3.5 mm

9 cm



Coupland
03-320-24
17 cm

04

for Fig. 10 - 17

for Fig. 10 - 17

for Fig. 10 - 17

for Fig. 10 - 17

for Fig. 10 - 17



Standard
 04-150-03
 12 cm
 No. 3



04-150-04
 12 cm
 No. 3



04-150-05
 12 cm
 No. 3



04-160-31
 21.5 cm
 No. 3L



04-161-31
 21 cm
 No. 3L

for Fig. 18 - 36

for Fig. 18 - 36

for Fig. 18 - 36

for Fig. 18 - 36



Standard
 04-170-04
 12 cm
 No. 4



04-180-41
 21.5 cm
 No. 4L



04-181-41
 21 cm
 No. 4L



04-190-34
 16 cm

for Fig. 10 - 17



04-200-07
 16 cm
 No. 7

for Fig. 10 - 17



04-200-71
 12.5 cm
 No. 7K

for Fig. 10 - 17



04-220-03
 15.5 cm
 No. 3

for Fig. 10 - 17



04-230-03
 14.5 cm
 No. 3

for Fig. 10 - 17



04-240-03
 14 cm
 No. 3



Ash
04-450-01 - 04-450-03



Fig. 1
04-450-01

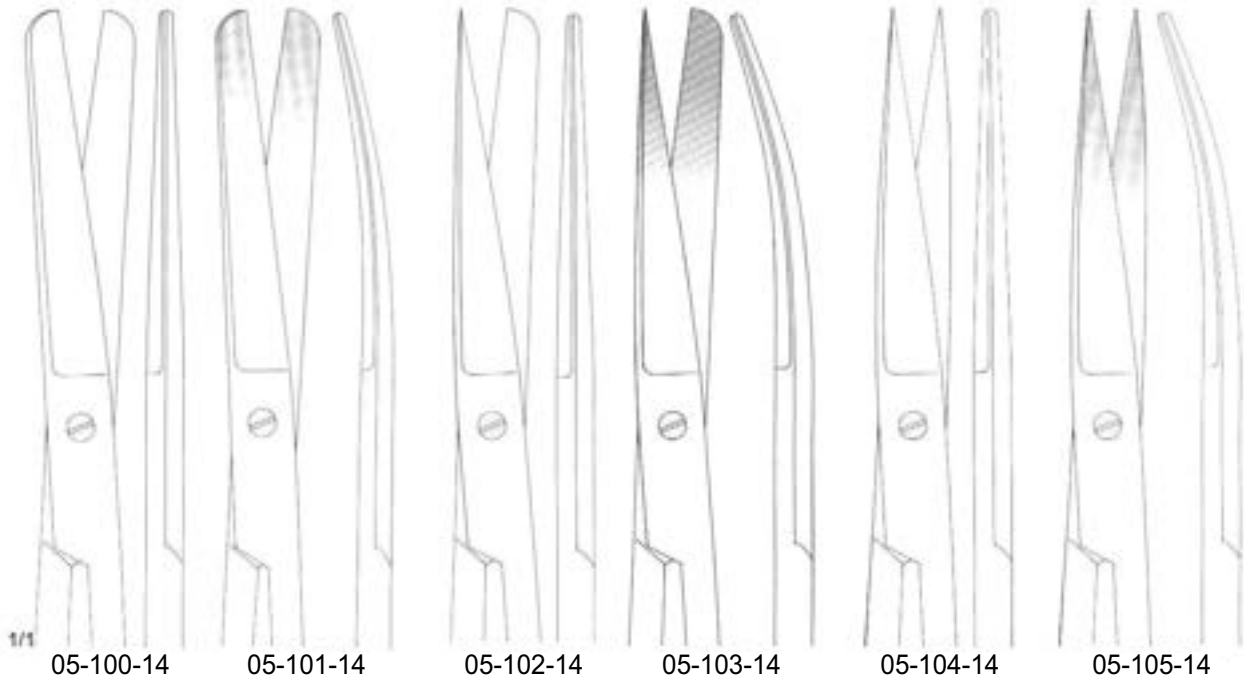


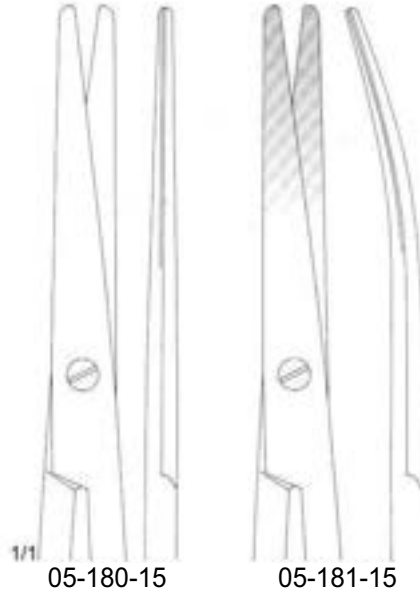
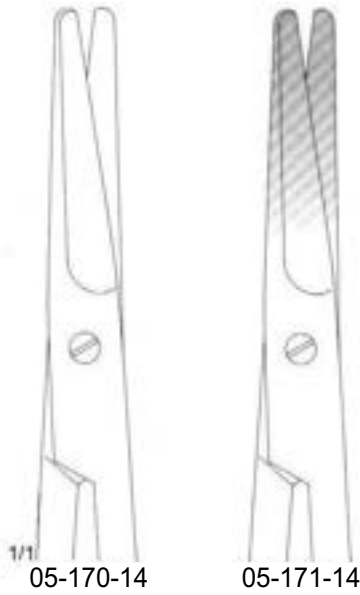
Fig. 2
04-450-02



Fig. 3
04-450-03

05





Mayo
 05-170-14 - 05-171-14
 14.5 cm



Mayo - Stille
 05-180-15 - 05-181-15
 15 cm

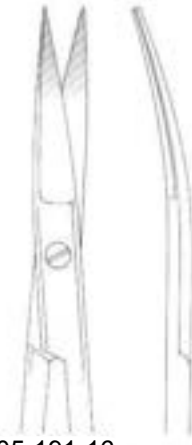


Kelly
05-190-16 - 05-191-18



05-190-16
16 cm

05-190-18
18 cm



05-191-16
16 cm

05-191-18
18 cm



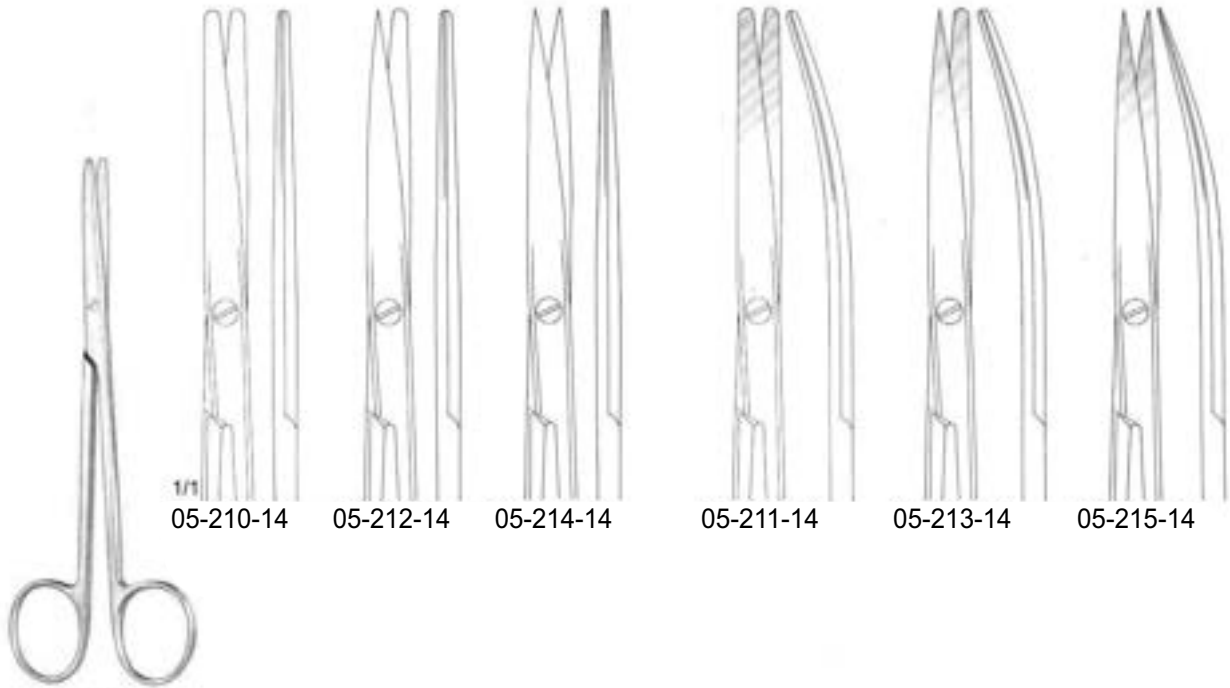
Metzenbaum - Baby
05-200-11 - 05-201-11
11.5 cm



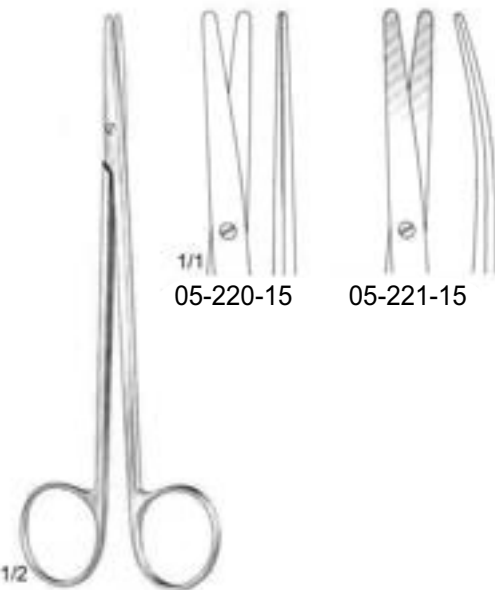
1/1
05-200-11



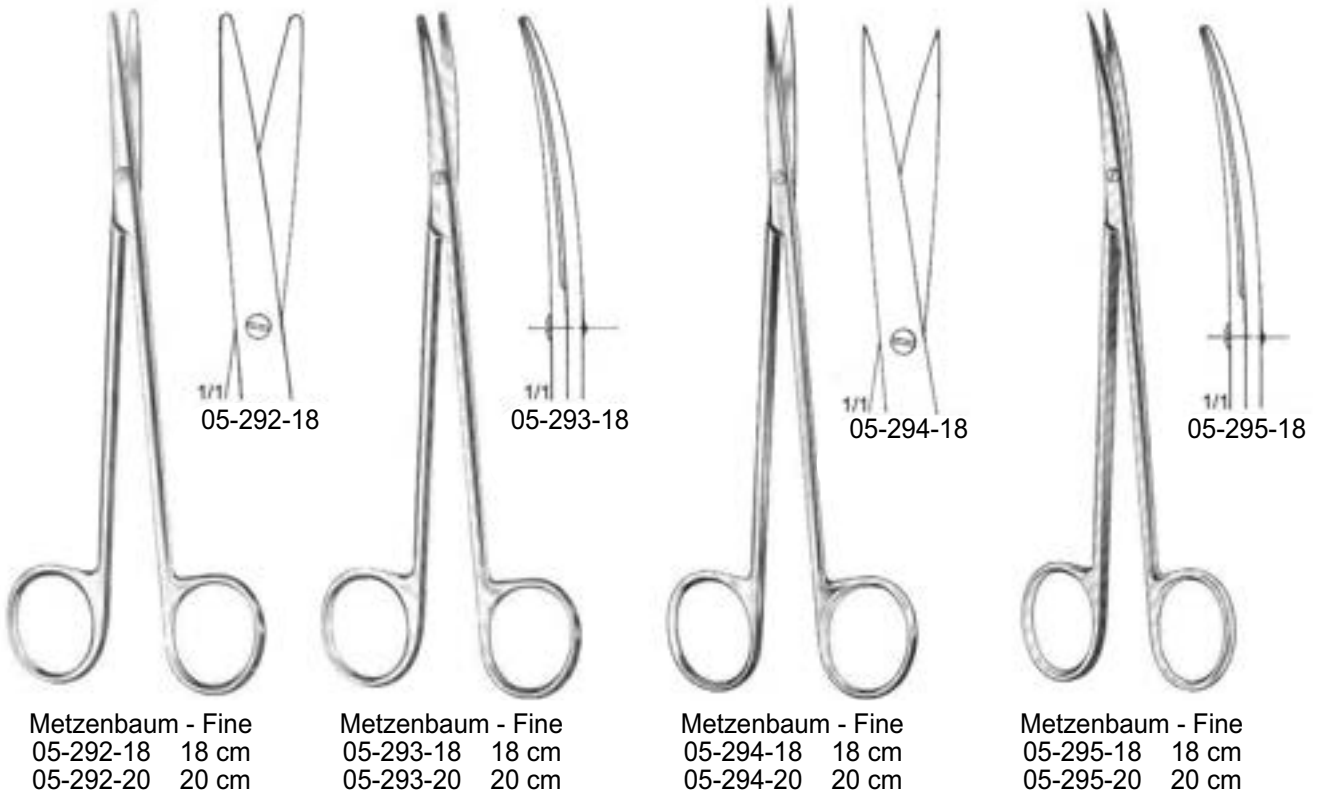
05-201-11

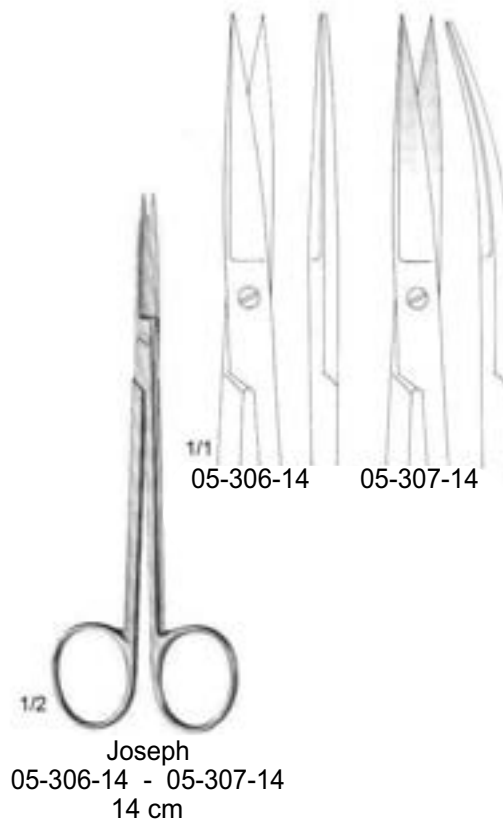
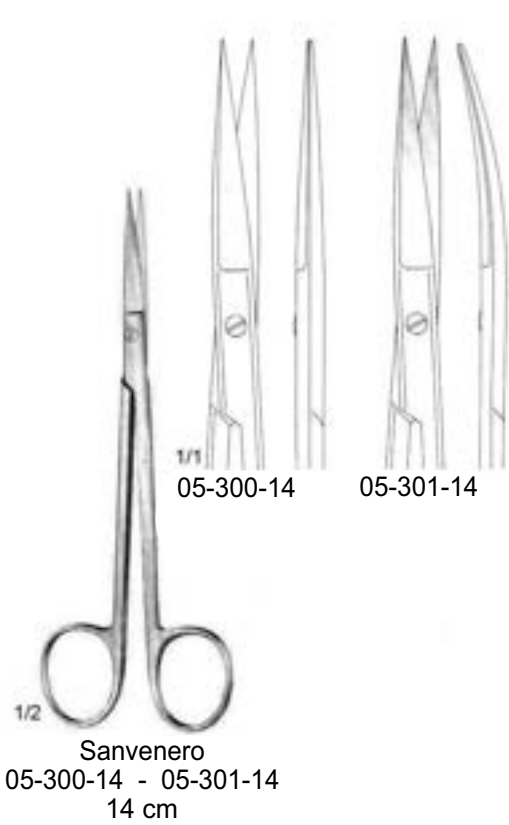


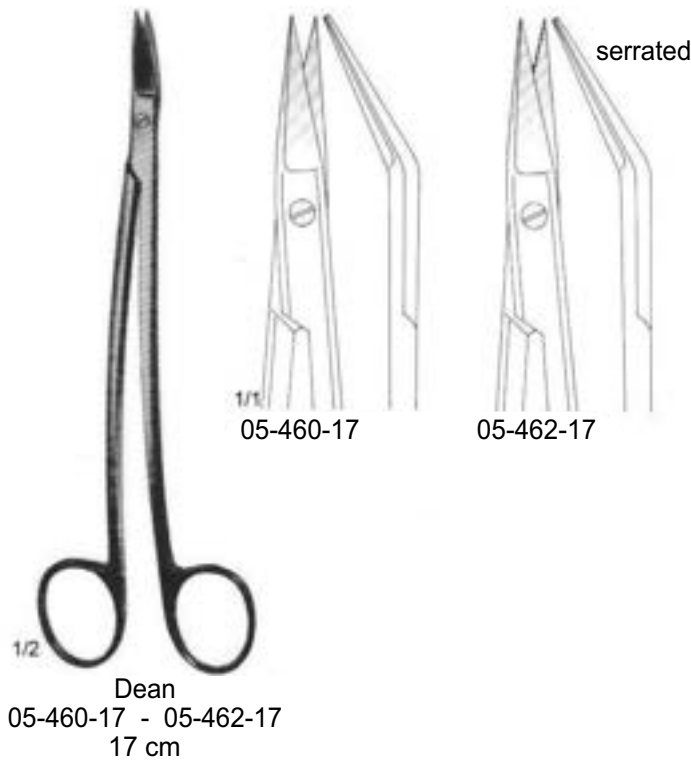
Metzenbaum
 05-210-14 - 05-215-14
 14.5 cm

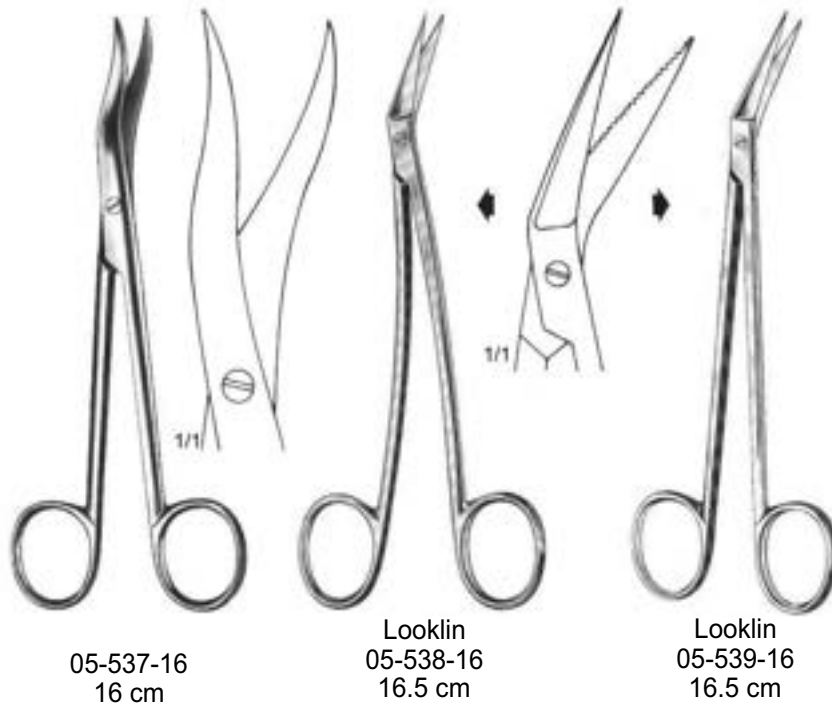
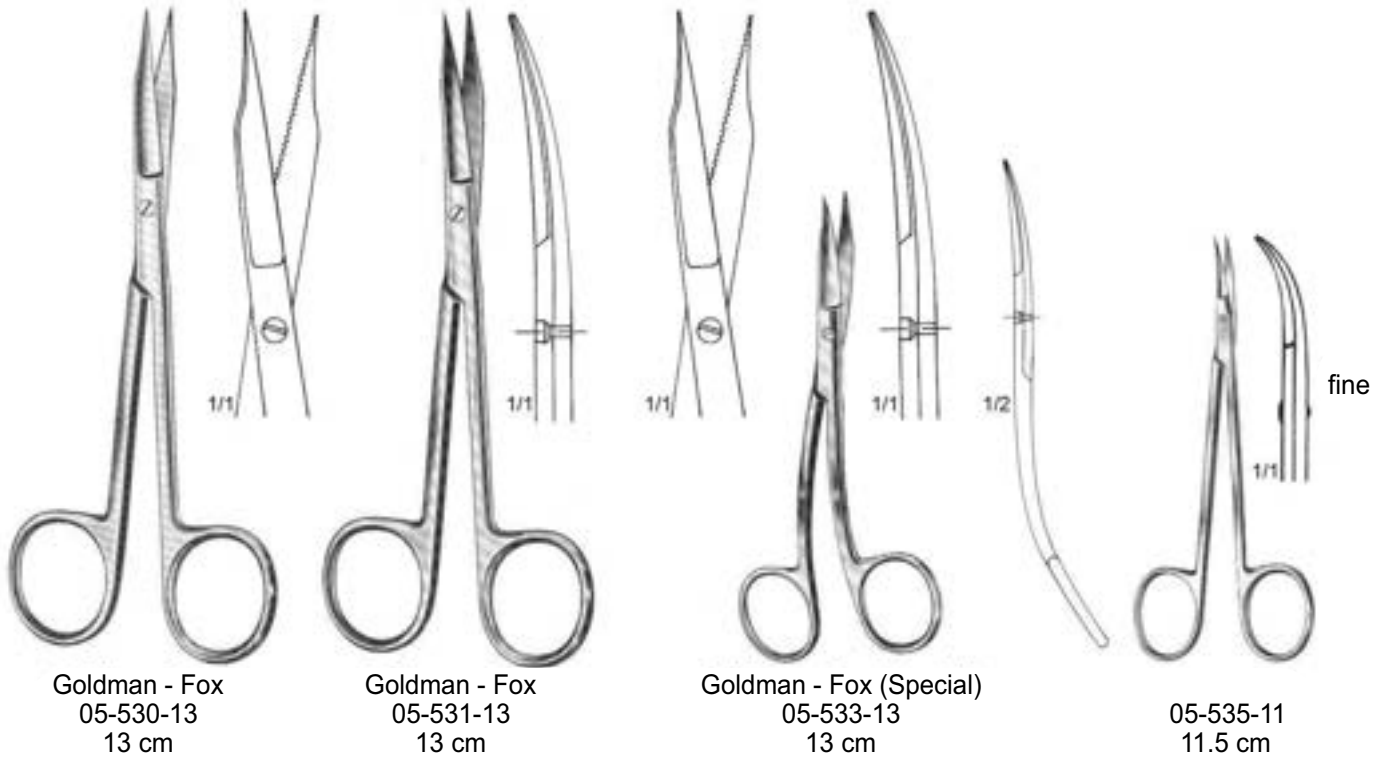


Metzenbaum
 05-220-15 - 05-221-15
 15 cm











Quinby
05-540-12
12 cm

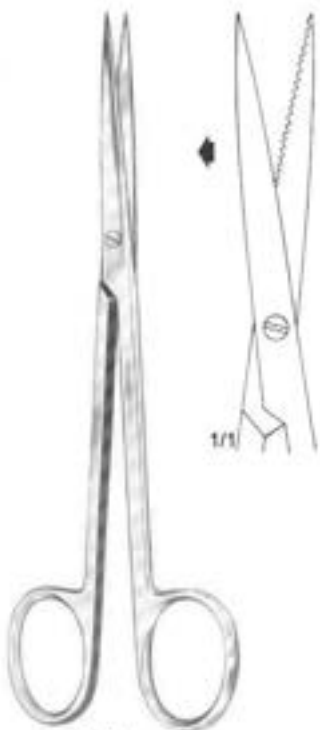
Quinby
05-541-12
12 cm



saw edge

Standard
05-542-11
11 cm

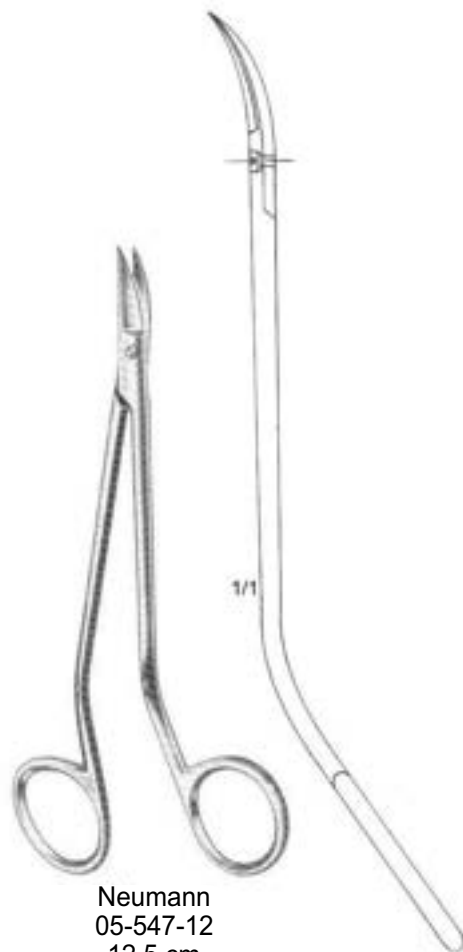
Standard
05-543-11
11 cm



Sullivan
05-544-14
14.5 cm



Sullivan
05-545-14
14.5 cm



Neumann
05-547-12
12.5 cm



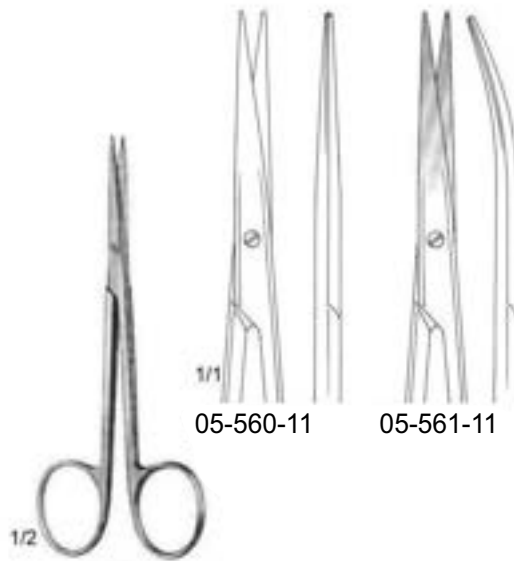
Wagner
 05-550-12 - 05-555-12
 12 cm



05-550-12 05-552-12 05-554-12



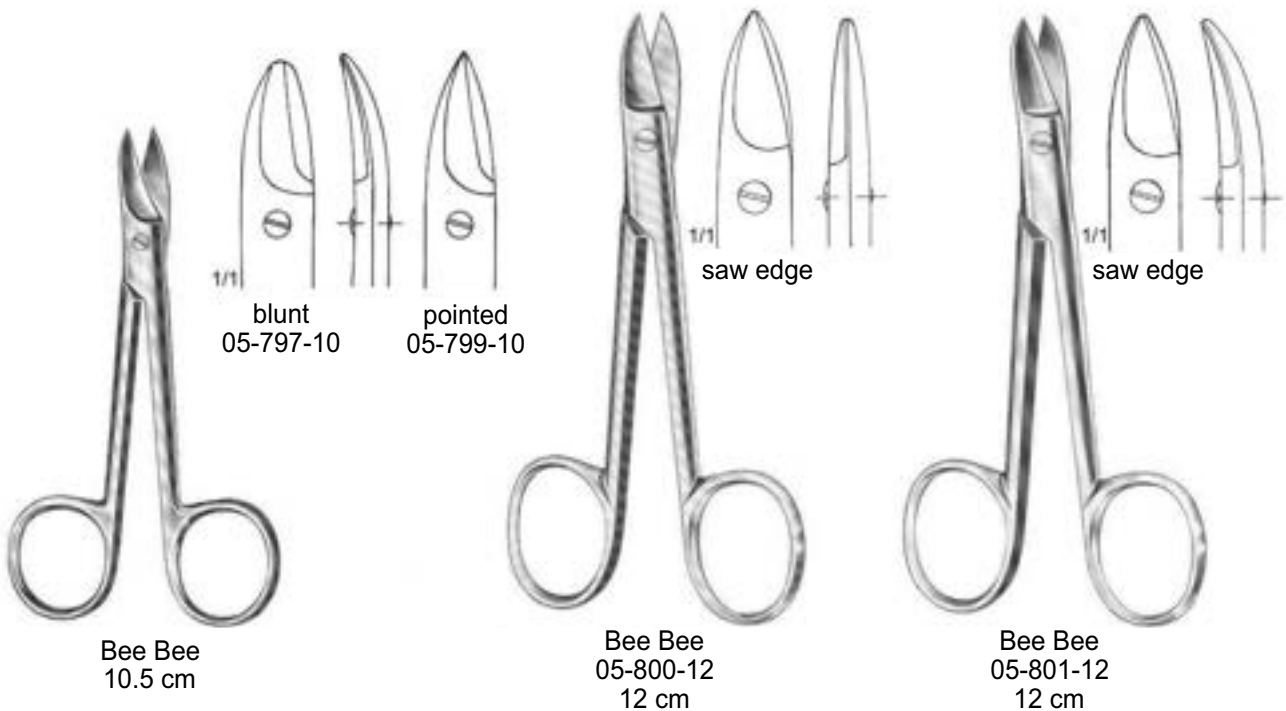
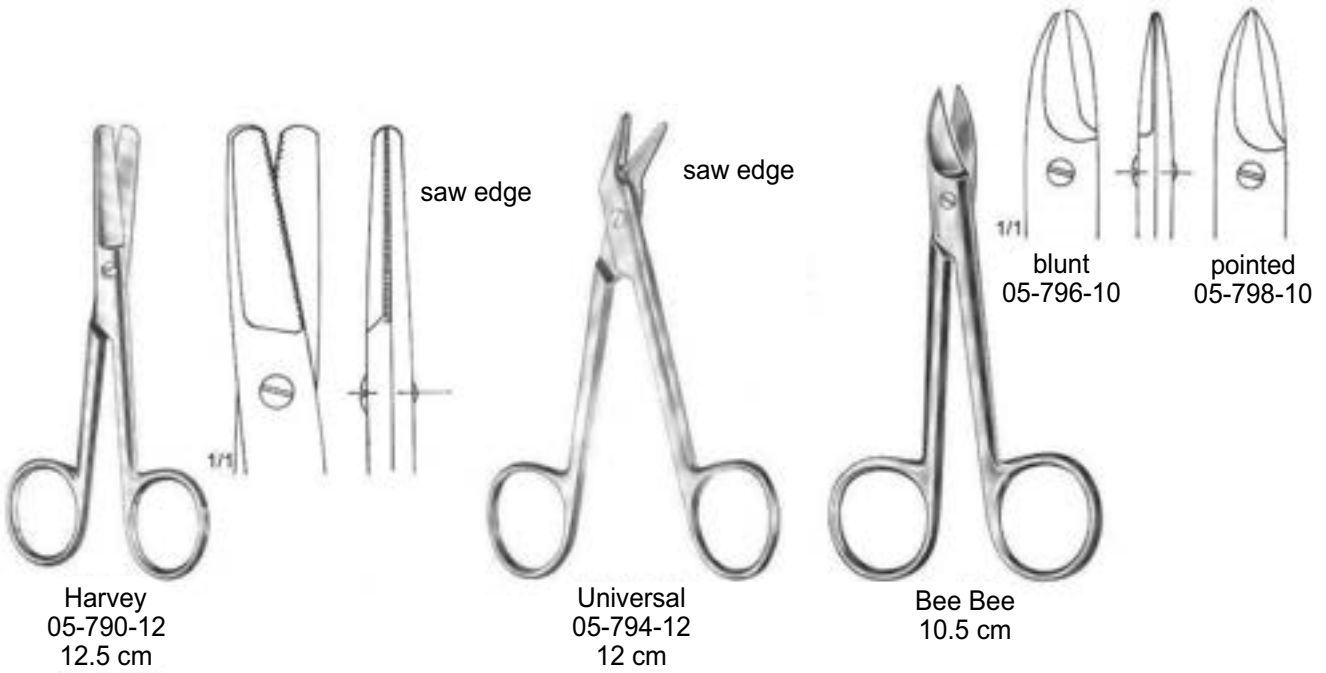
05-551-12 05-553-12 05-555-12



Littler
 05-560-11 - 05-561-11
 11.5 cm

1/1
 05-560-11

05-561-11





1/2
 Gomel
 05-869-14 - 05-869-16



1/1
 05-869-14
 14 cm



05-869-16
 16 cm



Hepp/Scheidel
 05-871-14 - 05-871-16



1/1
 05-871-14
 14 cm



05-871-16
 16 cm



1/2
 05-881-00 - 05-881-02



1/1
 05-881-00
 14 cm



05-881-01
 15.5 cm



Reill
 05-881-02
 15.5 cm

one blade saw edge



05-936-14
14.5 cm



05-937-14
14.5 cm

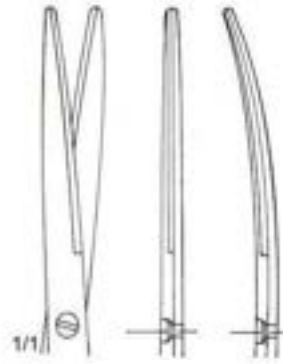
Metzenbaum - Fine



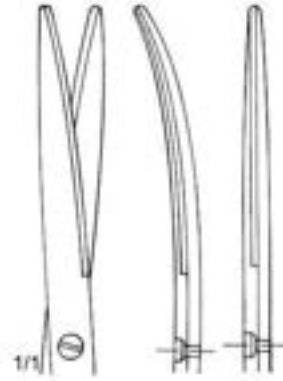
05-938-14
14.5 cm



05-939-14
14.5 cm



05-940-18
 05-941-18

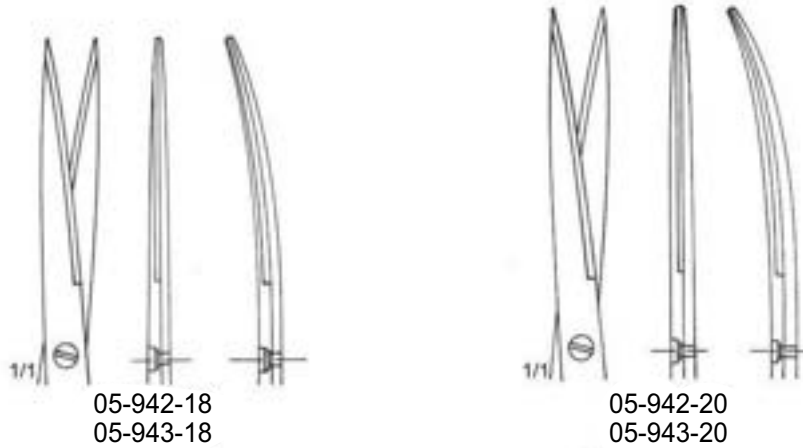


05-940-20
 05-941-20



Metzenbaum - Fine

straight		curved
05-940-18	18 cm	05-941-18
05-940-20	20 cm	05-941-20



Metzenbaum - Fine

straight		curved	
05-942-18	18 cm	05-943-18	
05-942-20	20 cm	05-943-20	



Metzenbaum - Fine
 05-949-01 - 05-949-23
 S-shaped







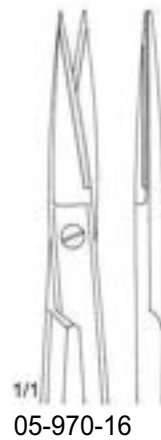
05-967-11
 11.5 cm



Ragnell(Killner)
 05-969-12
 12 cm



Kelly
 05-970-16 - 05-971-16
 16 cm



05-970-16



05-971-16

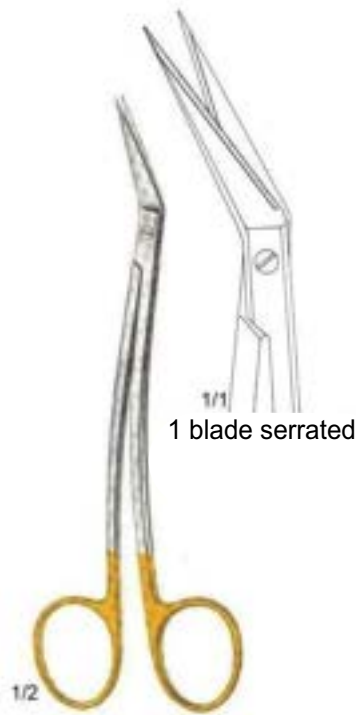
wire cutting



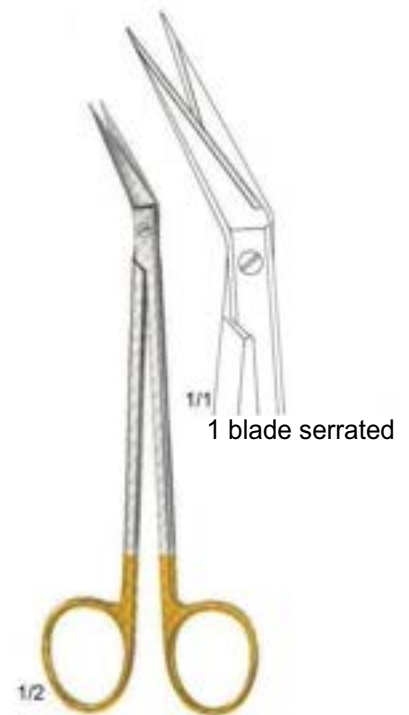
Universal
 05-974-12
 12 cm



Dean
 05-976-17
 17 cm

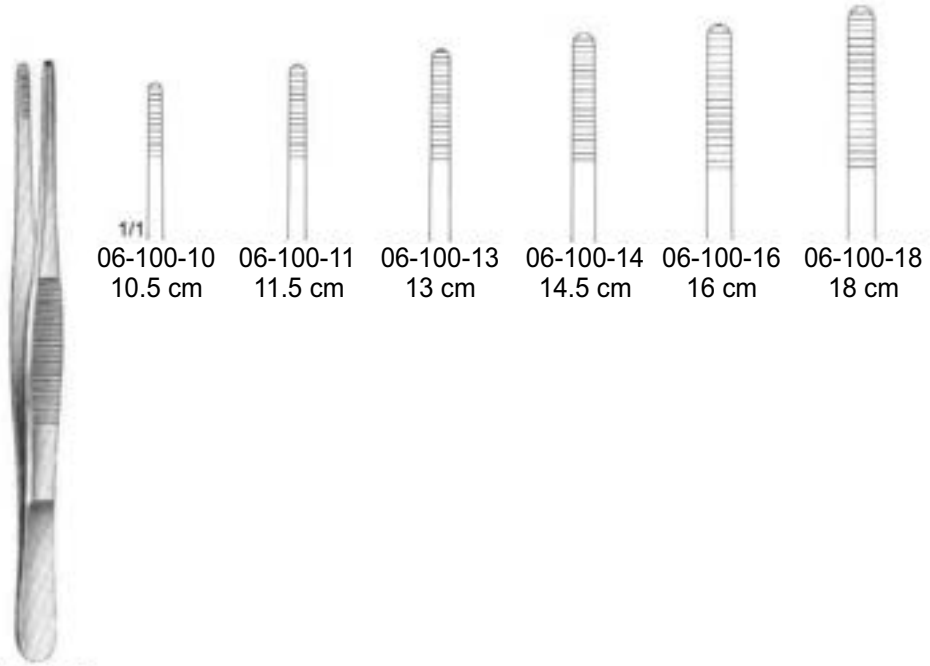


Locklin
 05-977-16
 16 cm

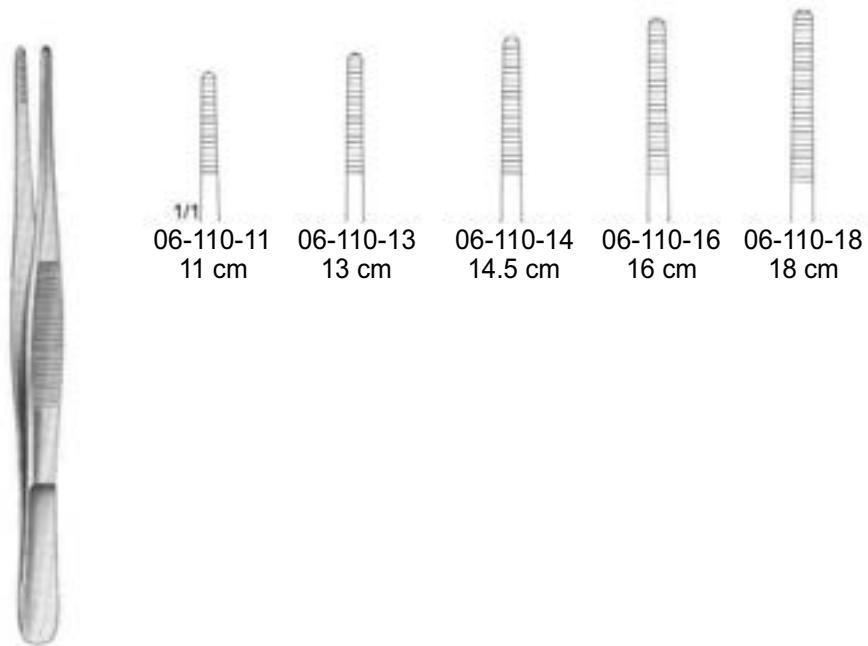


Locklin
 05-978-16
 16 cm

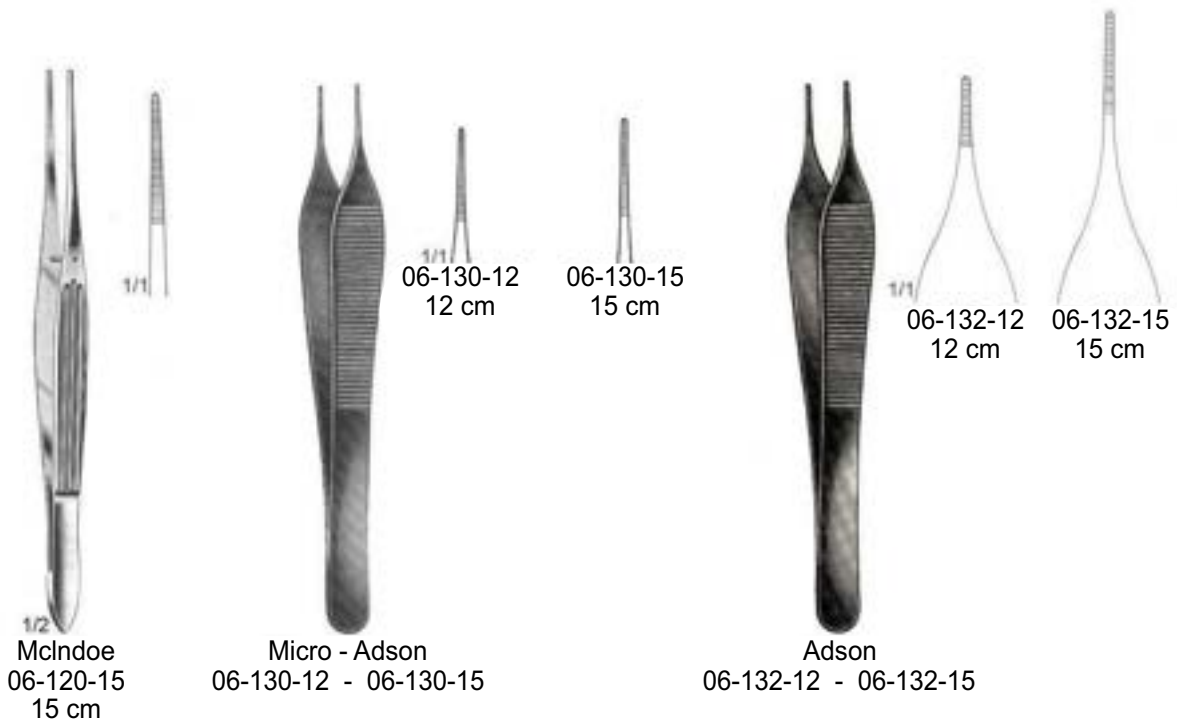
06



Standard
 06-100-10 - 06-100-30



Narrow
 06-110-11 - 06-110-30





Taylor
06-164-17 - 06-165-17
17 cm



Taylor
06-170-17
17.5 cm

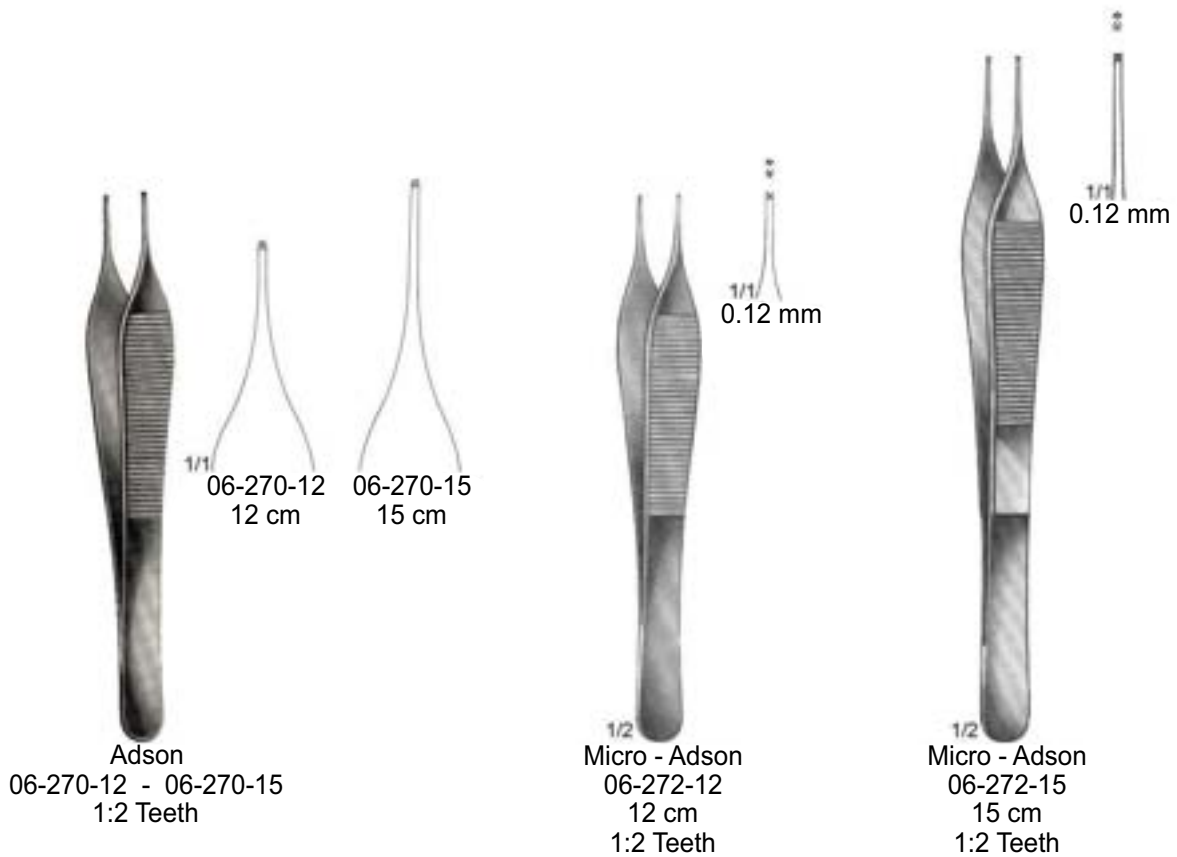
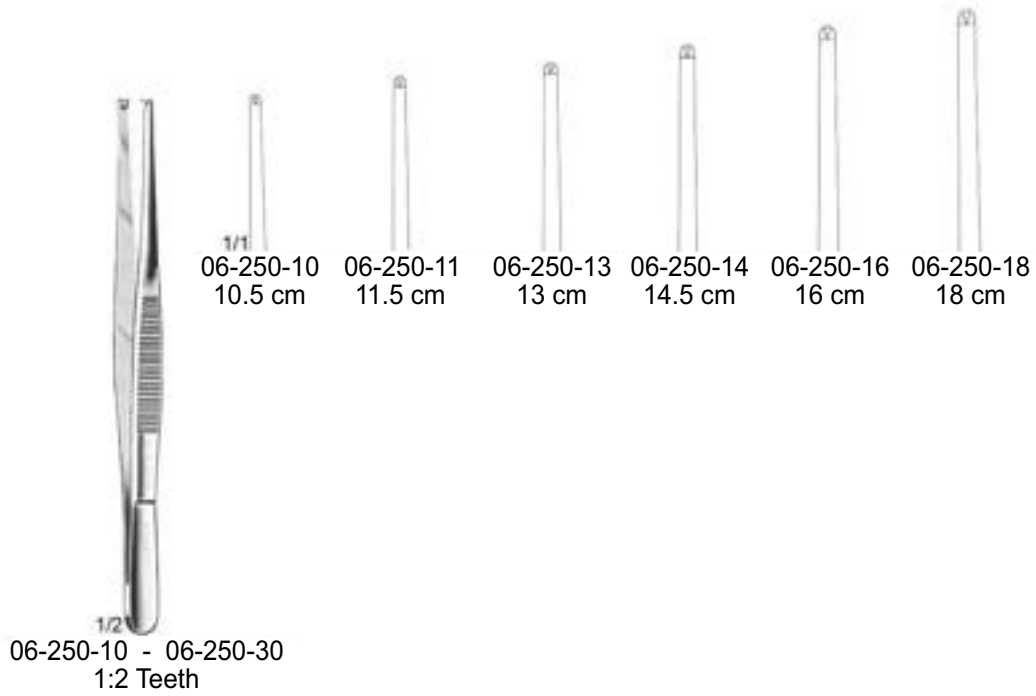


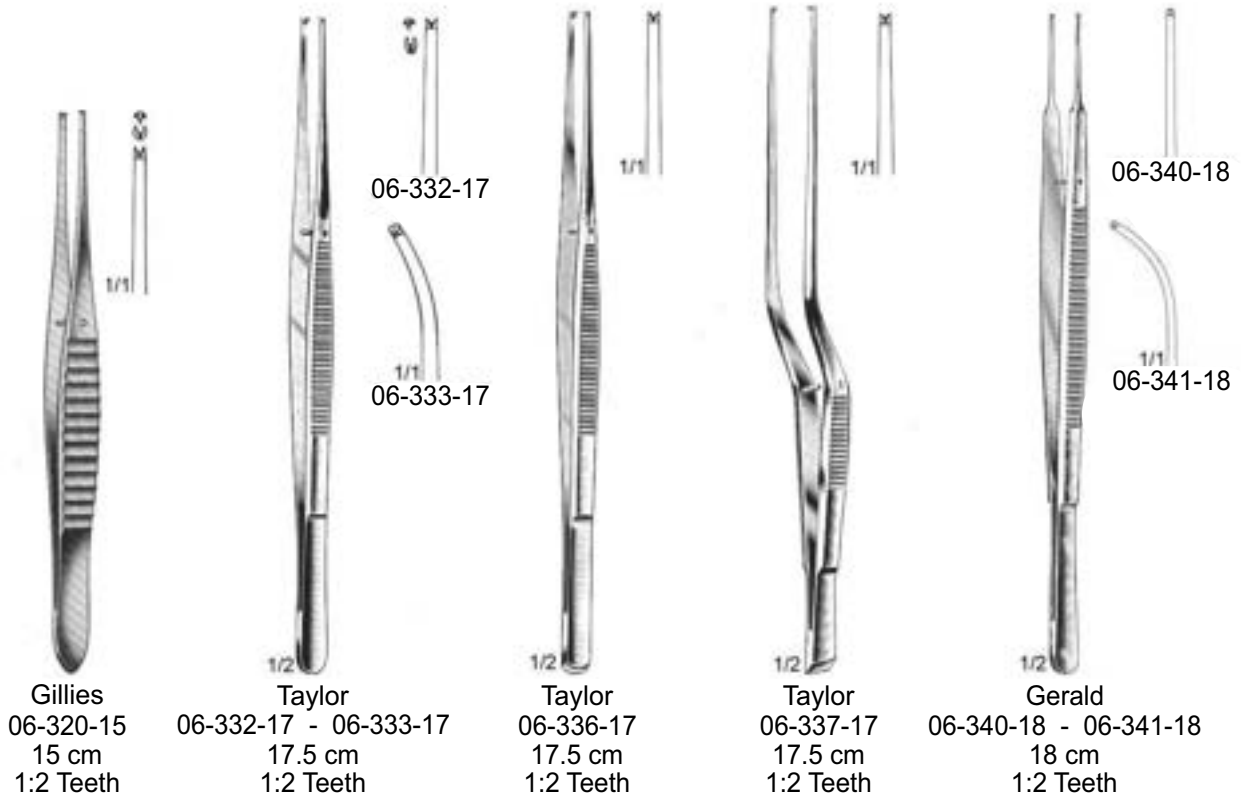
Taylor
06-170-18
18.5 cm

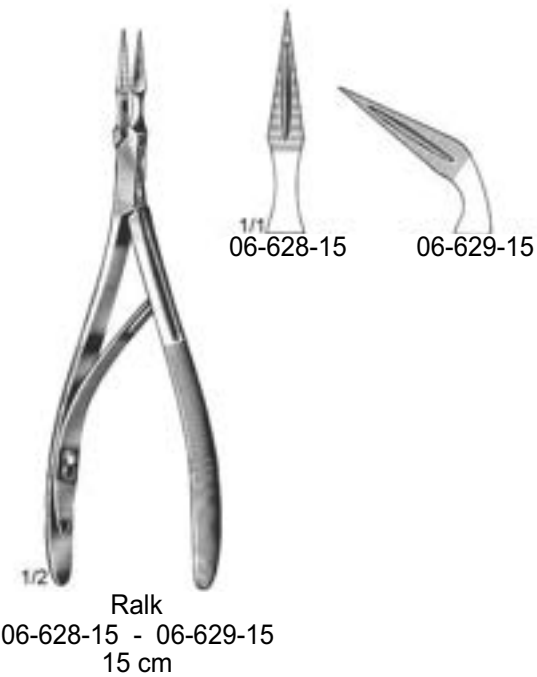
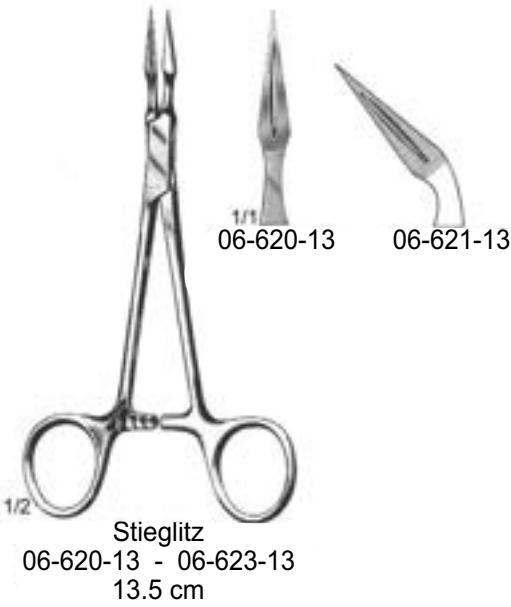


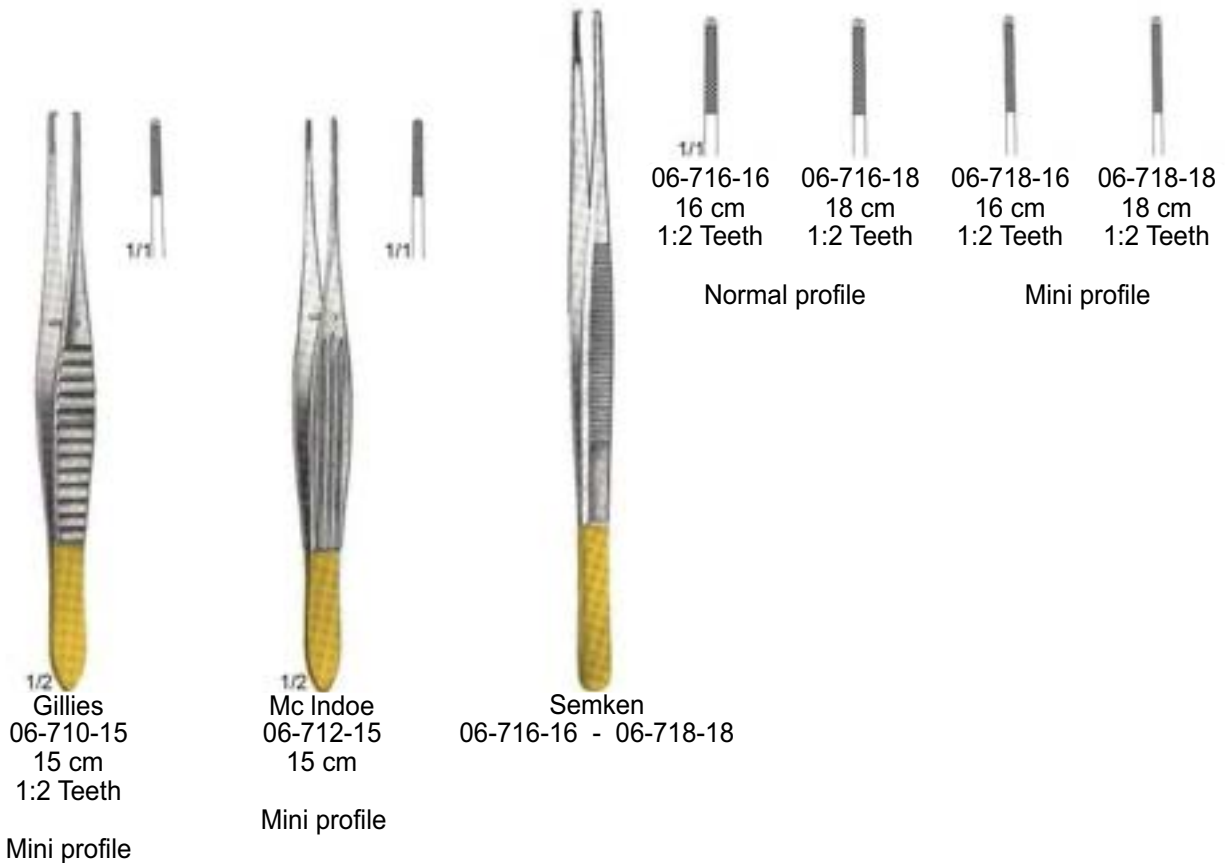
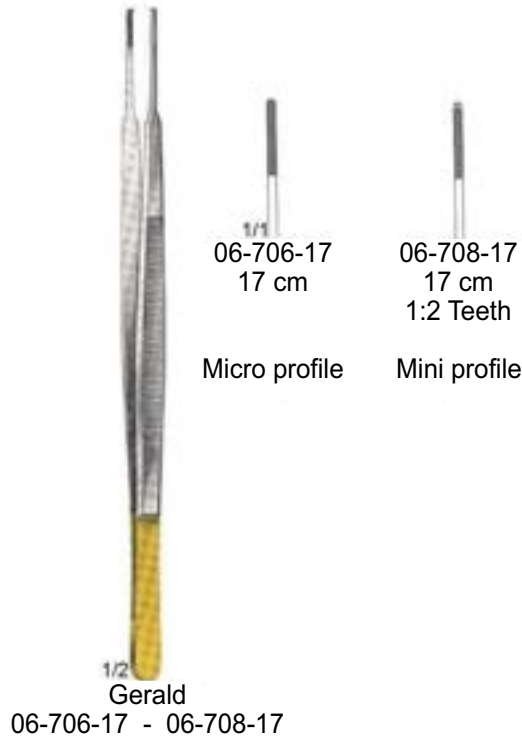
Gerald
06-176-18 - 06-177-18
18 cm

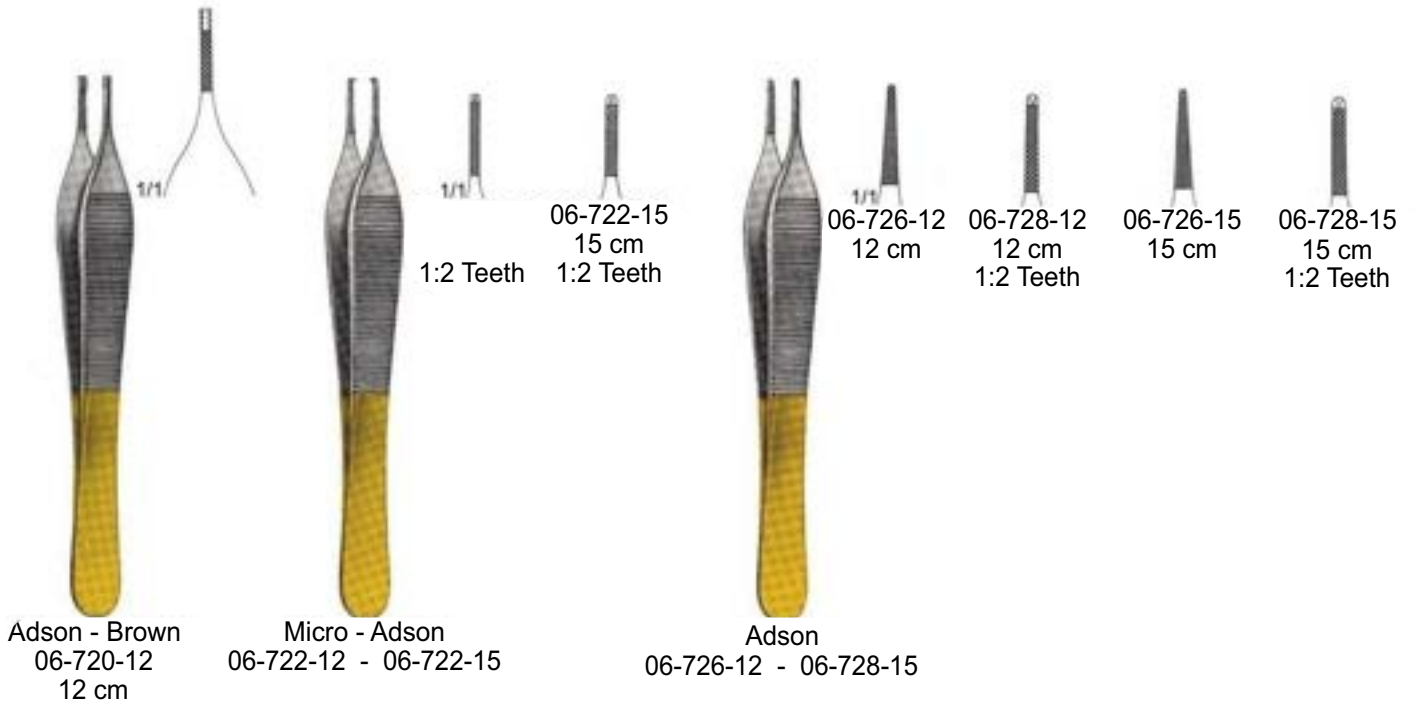








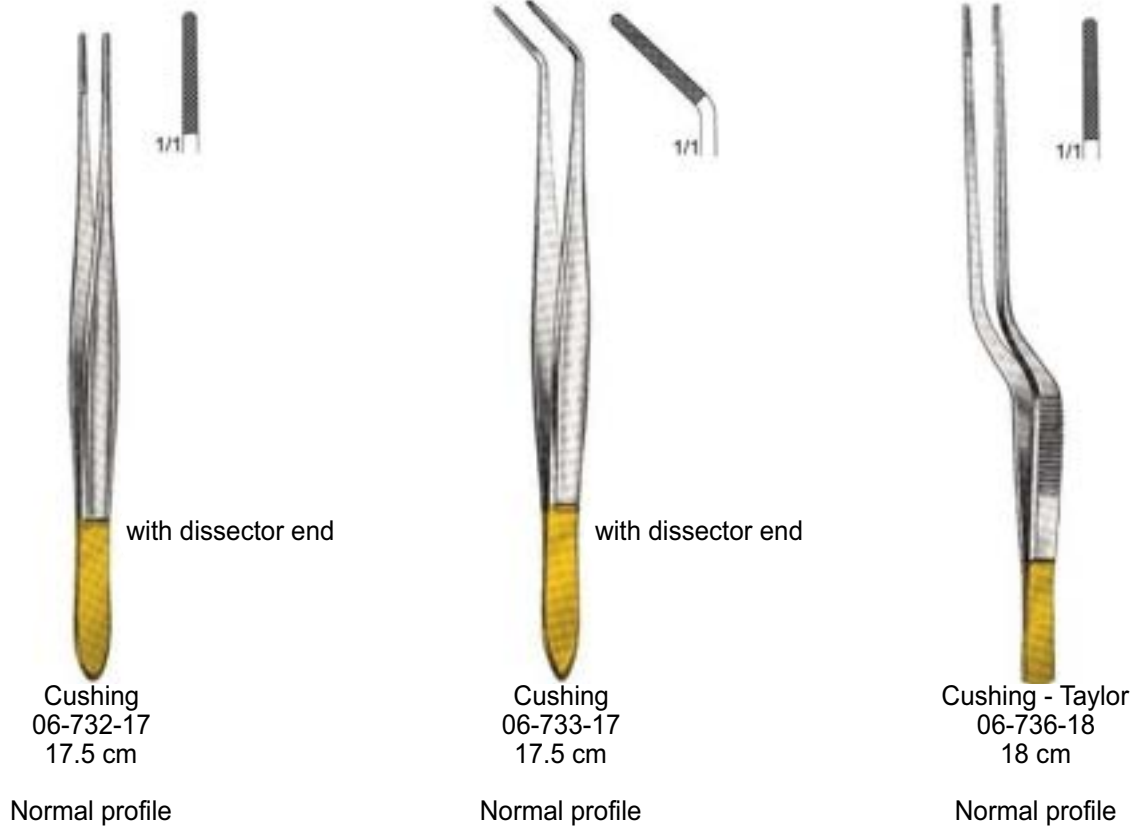




Normal profile

Mini profile

Normal profile

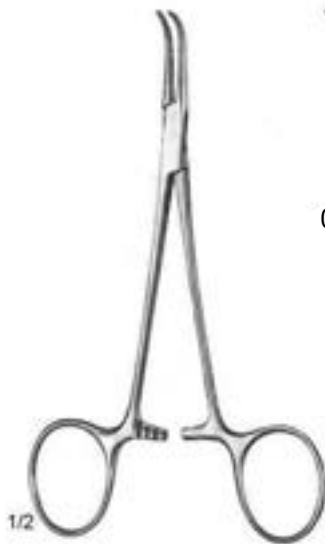


Normal profile

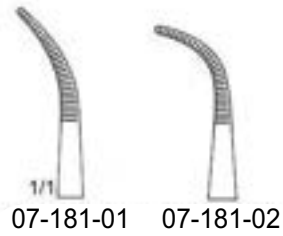
Normal profile

Normal profile

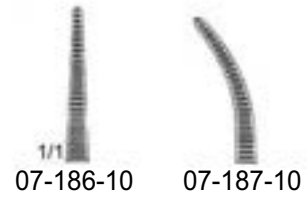
07



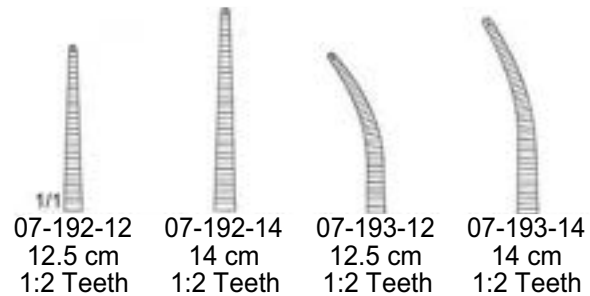
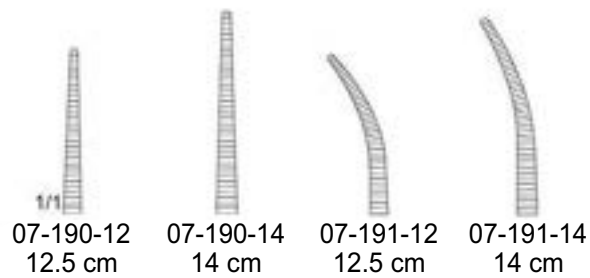
Baby - Mixer
 07-181-01 - 07-181-02
 14 cm



Hartmann
 07-186-10 - 07-187-10
 10 cm

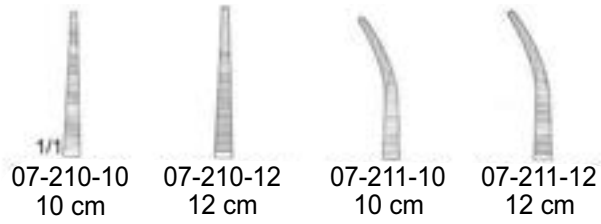


Halsted - Mosquito
 07-190-12 - 07-193-14

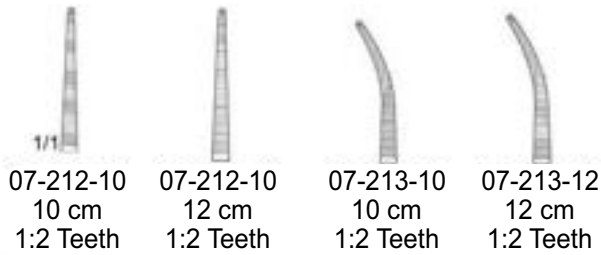




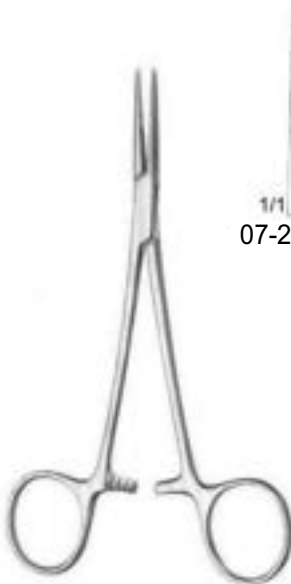
Micro - Mosquito
 07-210-10 - 07-213-12



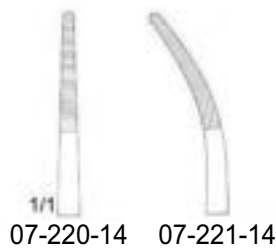
07-210-10 10 cm
 07-210-12 12 cm
 07-211-10 10 cm
 07-211-12 12 cm



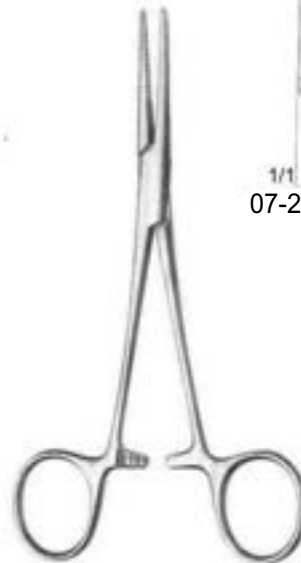
07-212-10 10 cm
 07-212-10 12 cm
 07-213-10 10 cm
 07-213-12 12 cm
 1:2 Teeth 1:2 Teeth 1:2 Teeth 1:2 Teeth



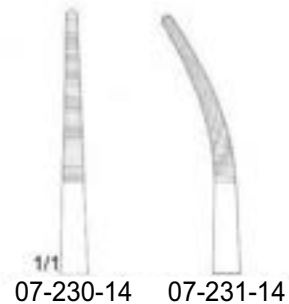
Providence - Hospital
 07-220-14 - 07-221-14
 14 cm



07-220-14 07-221-14

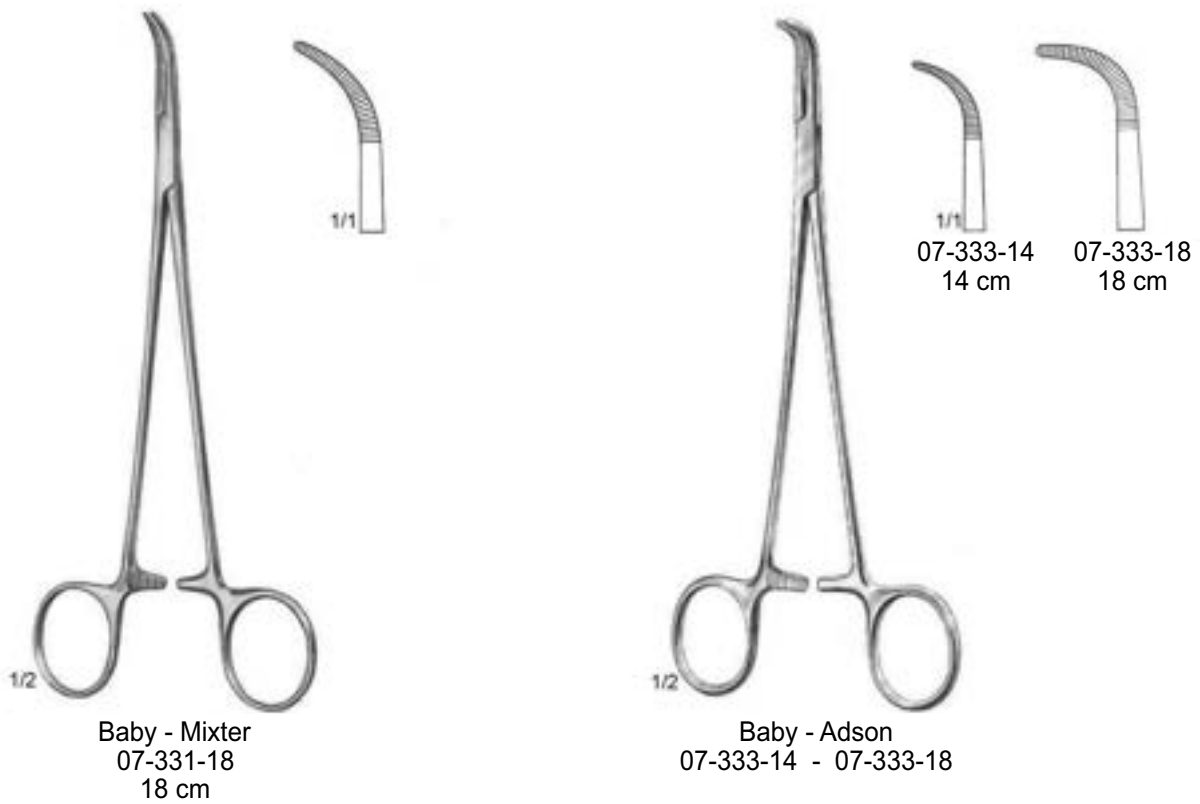
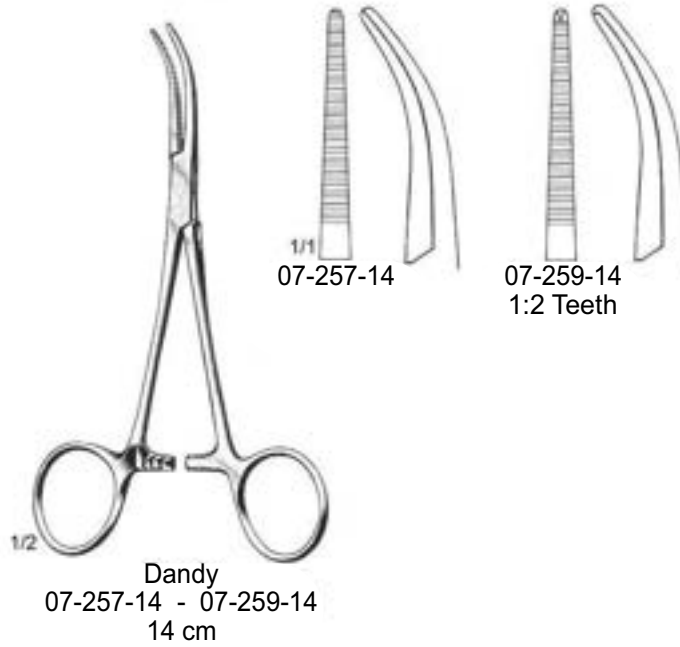


Kelly
 07-230-14 - 07-231-14
 14 cm



07-230-14 07-231-14

laterally curve





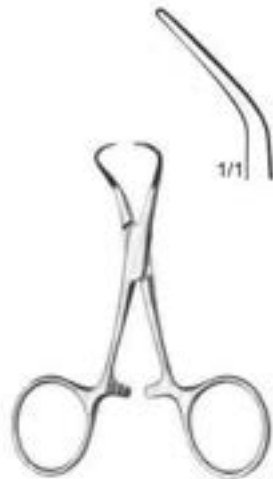
1/2
 Schaedel
 07-671-09
 9 cm



Jones
 07-673-05 5 cm
 07-673-09 9 cm



1/2
 Jones-Martin
 07-675-09
 9 cm
 with clip



1/1
 Backhaus
 07-685-08 8 cm
 07-685-11 11 cm
 07-685-13 13 cm



1/1
 Tohoku
 07-697-10 10 cm
 07-697-13 13 cm

08



Gross - Maier
 08-150-20 - 08-151-25

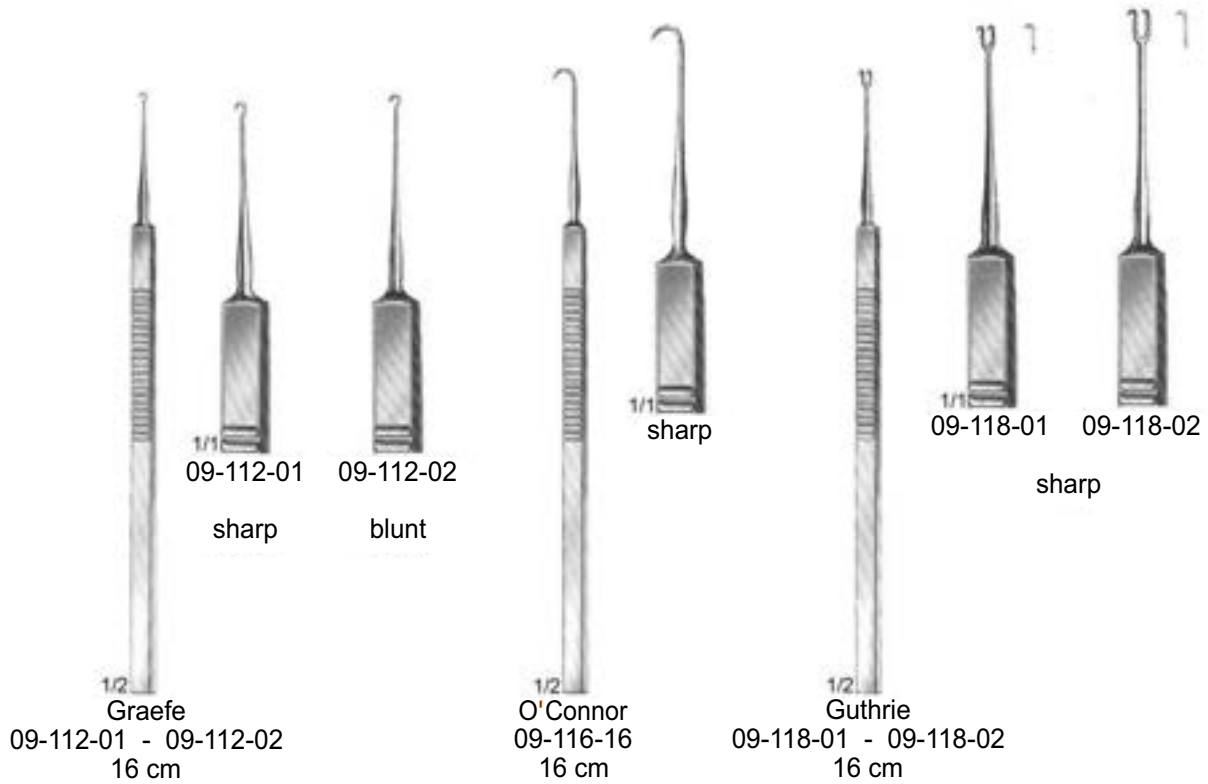


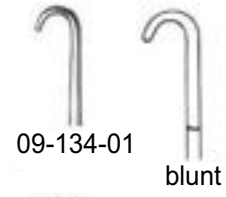
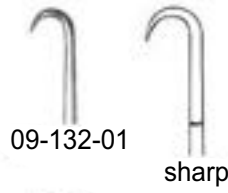
1/1
 08-150-20 20 cm
 08-150-22 22 cm
 08-150-25 25 cm

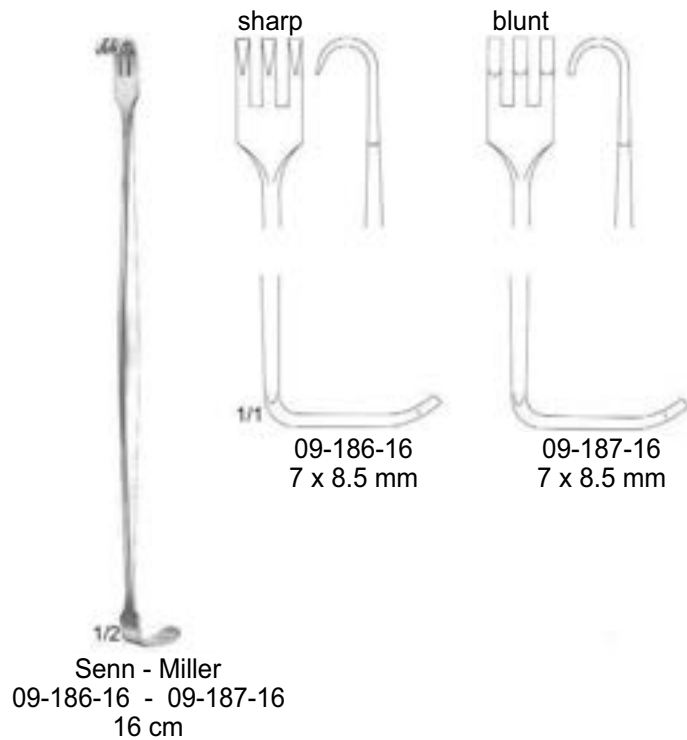
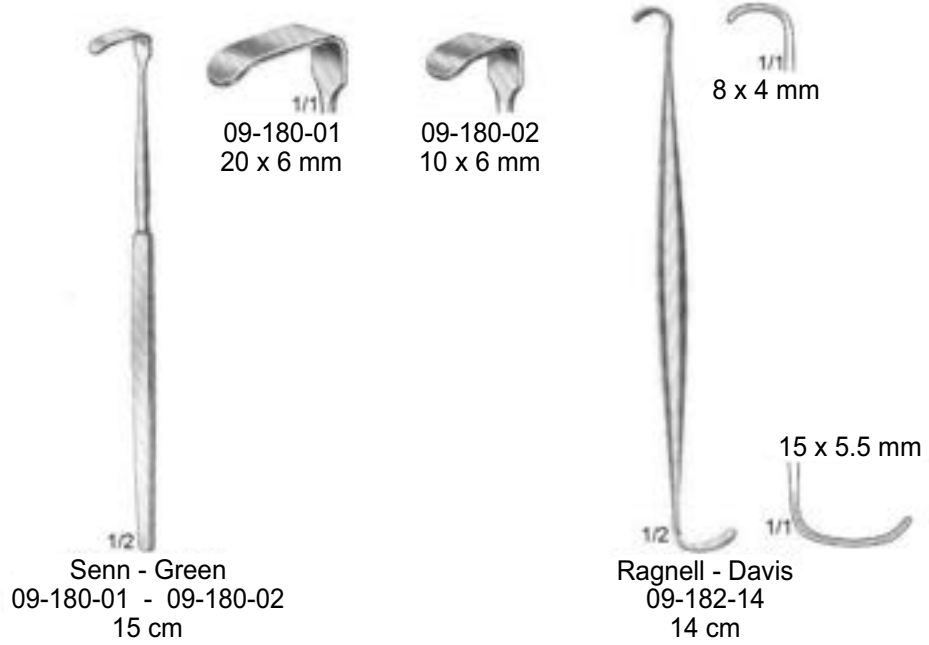


08-151-20 20 cm
 08-151-22 22 cm
 08-151-25 25 cm

09

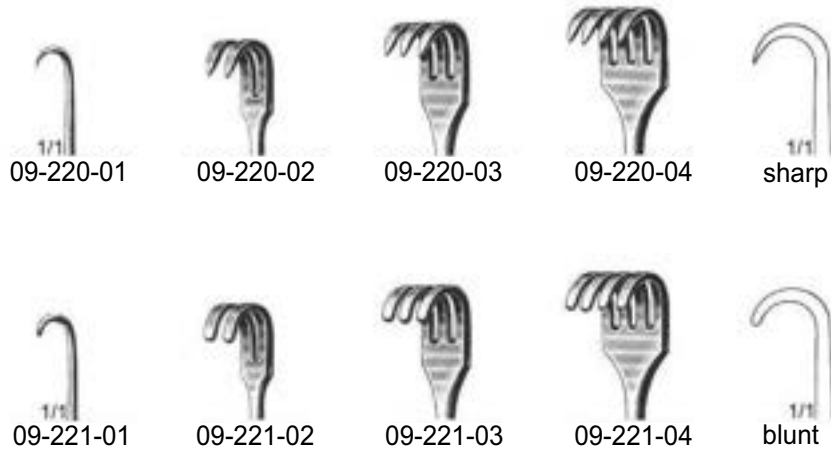








1/2
Volkman
09-220-01 - 09-221-04
22 cm





1/2
 Langenbeck
 09-281-01 - 09-281-05
 22 cm



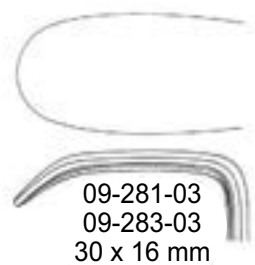
1/2
 Langenbeck
 09-283-01 - 09-283-05
 22 cm



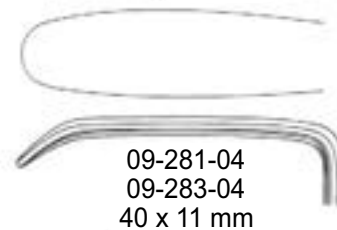
09-281-01
 09-283-01
 30 x 11 mm



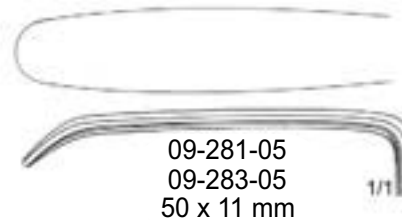
09-281-02
 09-283-02
 30 x 14 mm



09-281-03
 09-283-03
 30 x 16 mm



09-281-04
 09-283-04
 40 x 11 mm



09-281-05
 09-283-05
 50 x 11 mm

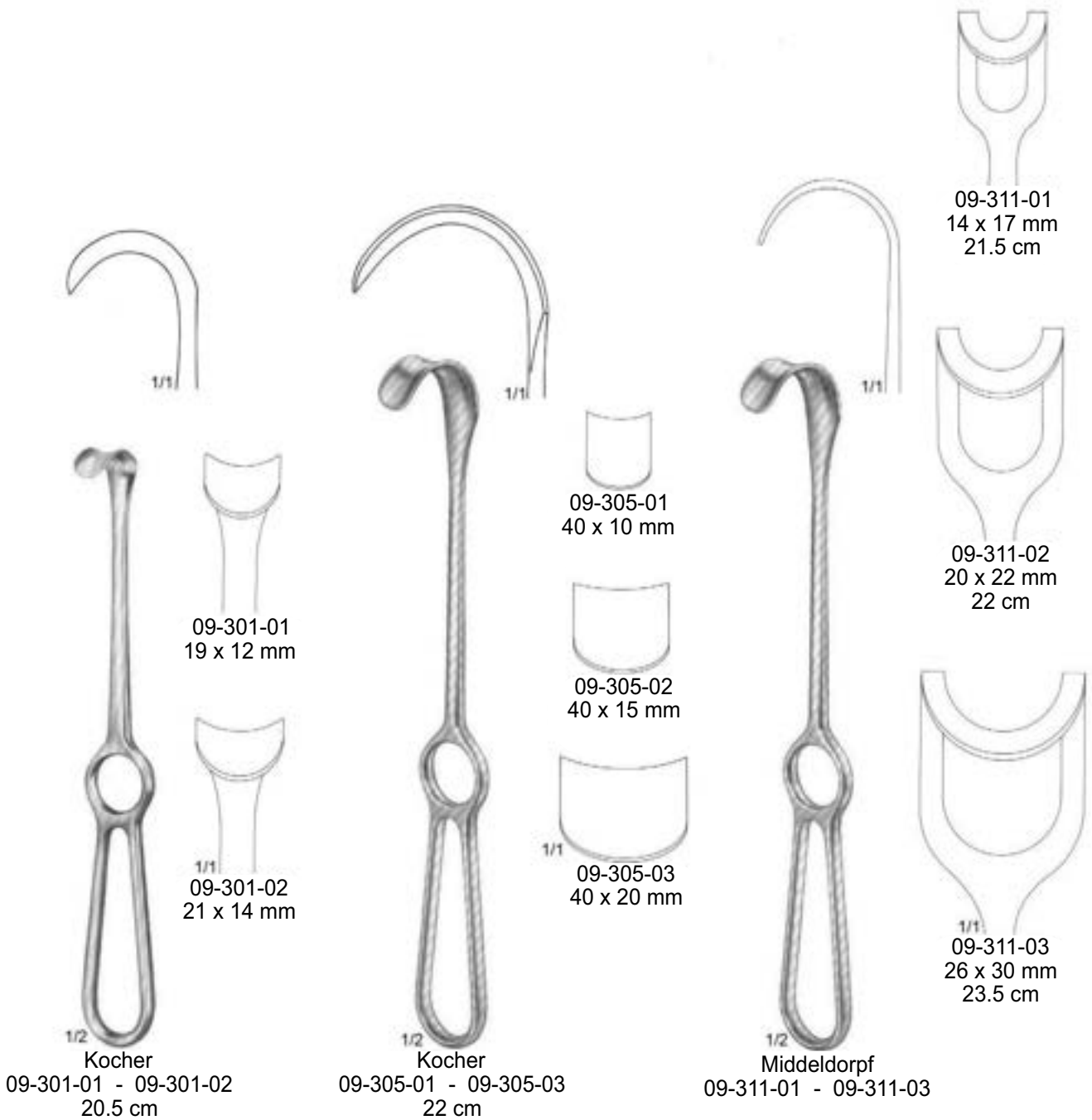
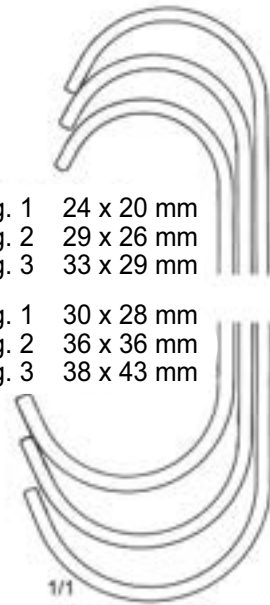




Fig. 1 24 x 20 mm
 Fig. 2 29 x 26 mm
 Fig. 3 33 x 29 mm

Fig. 1 30 x 28 mm
 Fig. 2 36 x 36 mm
 Fig. 3 38 x 43 mm

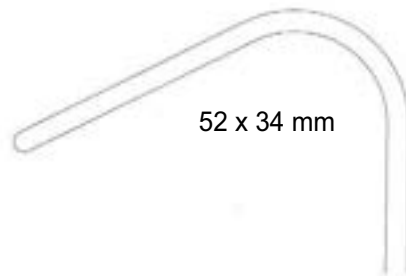


Roux

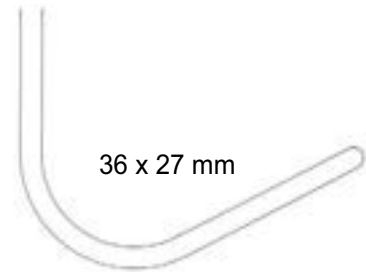
09-561-01 Fig. 1 15 cm
 09-561-02 Fig. 2 16 cm
 09-561-03 Fig. 3 17 cm



Collin - Hartmann
 09-565-01 - 09-565-02



09-565-01
 14 cm



09-565-02
 16 cm



Fig. 2 30 x 10 mm
Fig. 1 26 x 10 mm



Fig. 2 27 x 16 mm
Fig. 1 23 x 16 mm



Fig. 2 22 x 15 mm
Fig. 1 19 x 15 mm

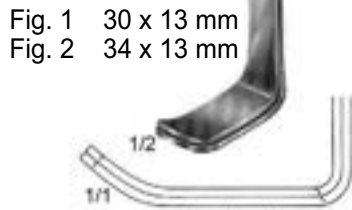


Fig. 1 30 x 13 mm
Fig. 2 34 x 13 mm

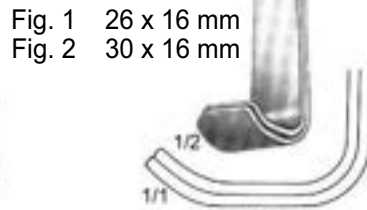


Fig. 1 26 x 16 mm
Fig. 2 30 x 16 mm

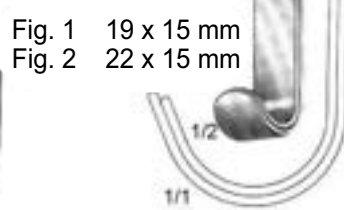


Fig. 1 19 x 15 mm
Fig. 2 22 x 15 mm



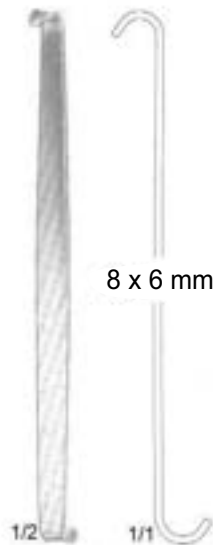
Farabeuf
09-573-00 Set
12 cm



Farabeuf
09-575-00 Set
15 cm

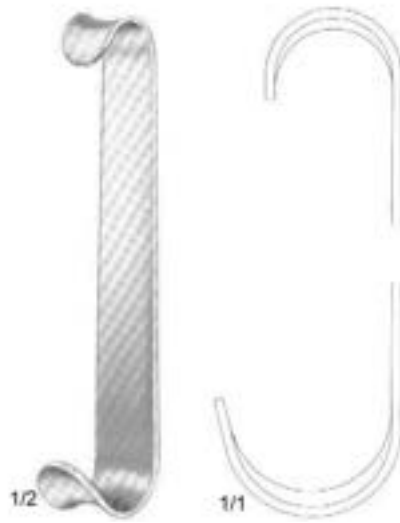


Parker
09-577-01 Set
13.5 cm

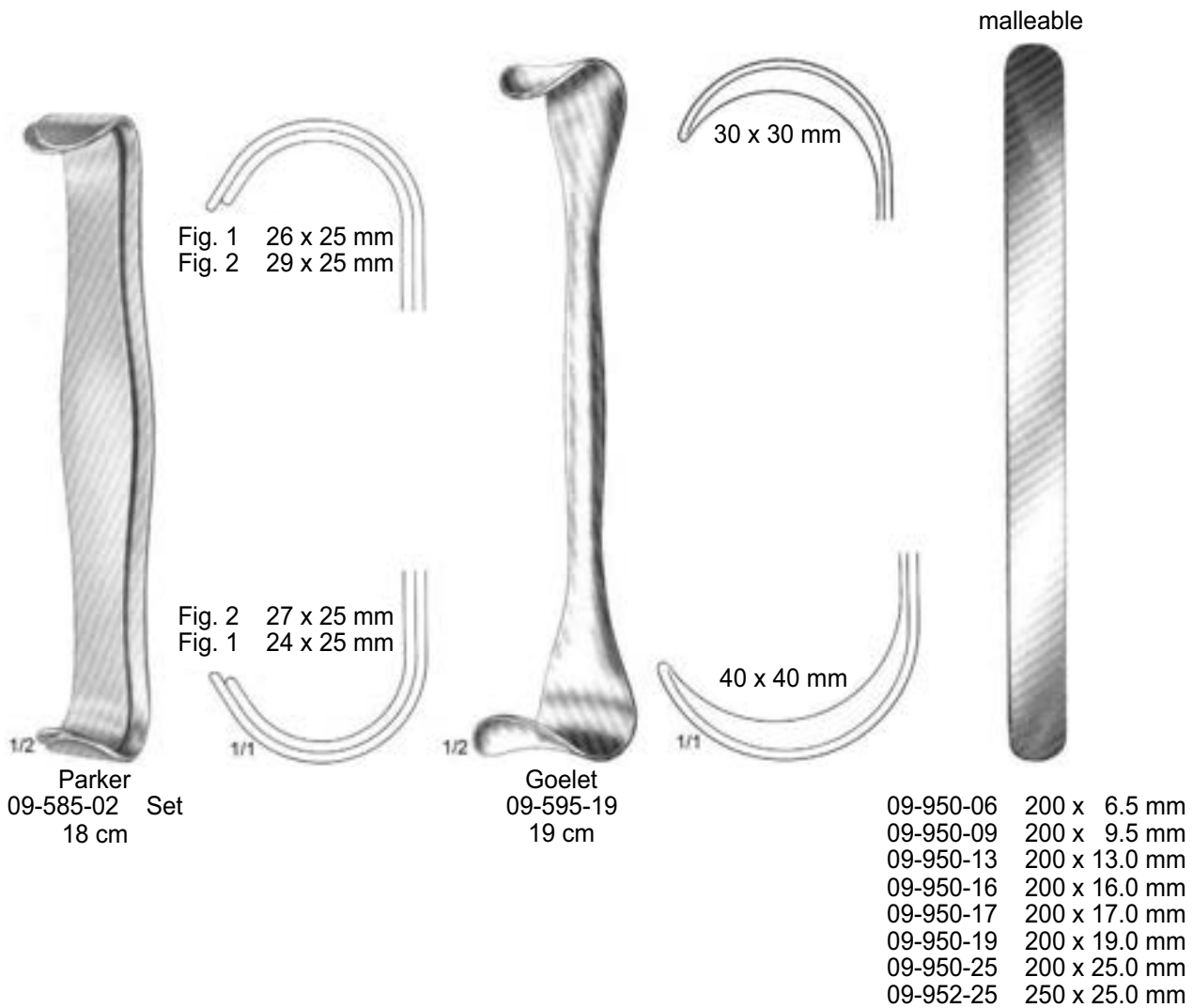


8 x 6 mm

Mini - Roux
09-579-06
14 cm



Baby - Roux
09-583-13
13 cm



10



10-100-11 11.5 cm
 10-100-13 13.0 cm
 10-100-14 14.5 cm
 10-100-16 16.0 cm
 Ø 2 mm



10-110-11 11.5 cm
 10-110-13 13.0 cm
 10-110-14 14.5 cm
 10-110-16 16.0 cm
 Ø 1 mm



10-120-11 11.5 cm
 10-120-13 13.0 cm
 10-120-14 14.5 cm
 10-120-16 16.0 cm
 Ø 1 mm



10-124-11 11.5 cm
 10-124-13 13.0 cm
 10-124-14 14.5 cm
 10-124-16 16.0 cm
 Ø 2 mm



10-126-11 11.5 cm
 10-126-13 13.0 cm
 10-126-14 14.5 cm
 10-126-16 16.0 cm
 Ø 2 mm





Mod. Martin
 10-230-12 - 10-230-16



10-230-12	12 cm
10-230-14	14 cm
10-230-16	16 cm

Ø 1.2 mm



10-232-12	12 cm
10-232-14	14 cm
10-232-16	16 cm

Ø 1.5 mm

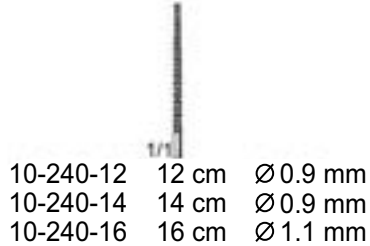


10-234-12	12 cm
10-234-14	14 cm
10-234-16	16 cm

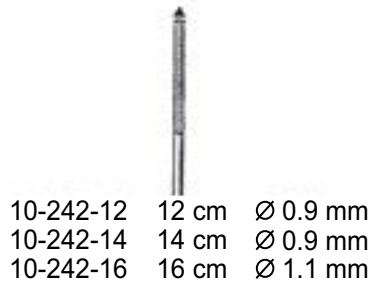
Ø 1.5 mm



Farrell (Lathbury - Uebe)
 10-240-12 - 10-240-16

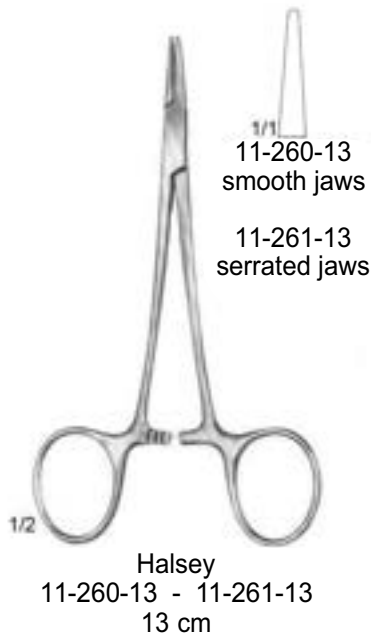
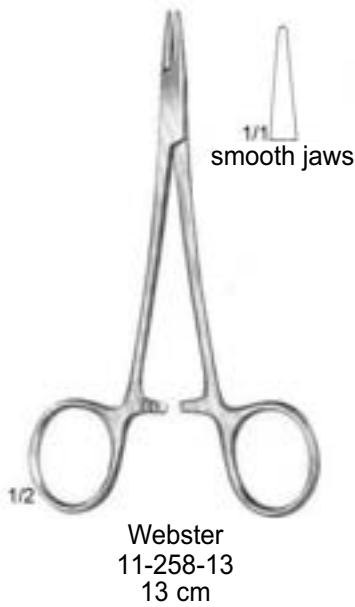


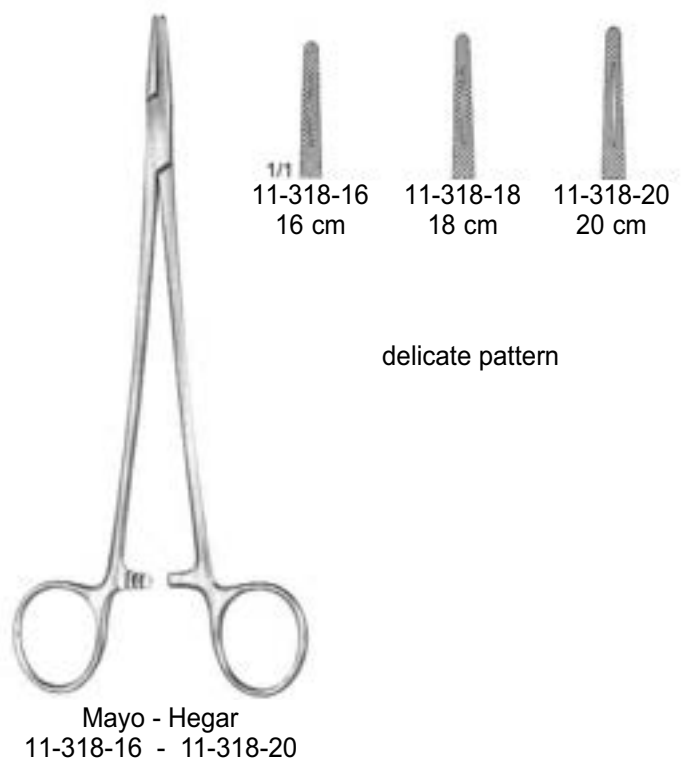
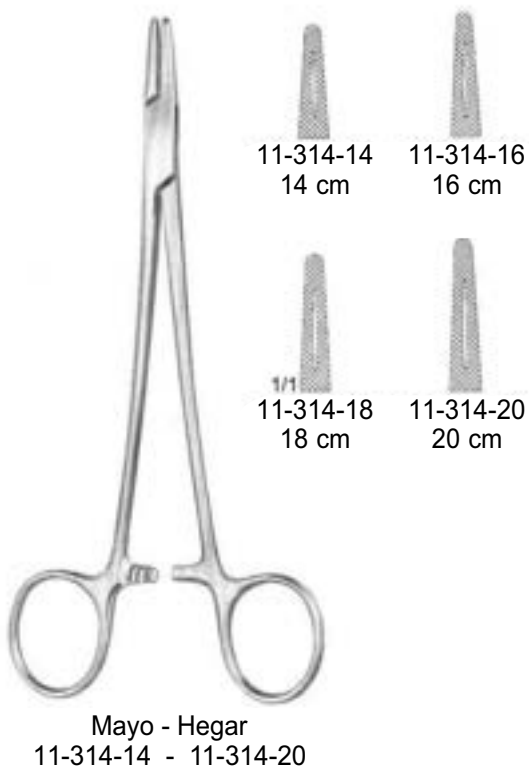
10-240-12	12 cm	Ø 0.9 mm
10-240-14	14 cm	Ø 0.9 mm
10-240-16	16 cm	Ø 1.1 mm



10-242-12	12 cm	Ø 0.9 mm
10-242-14	14 cm	Ø 0.9 mm
10-242-16	16 cm	Ø 1.1 mm

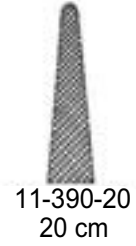
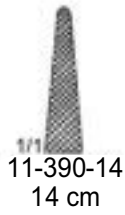
11



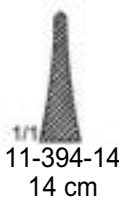




Mathieu
 11-390-14 - 11-390-20



Mathieu - Delicate
 11-394-14 - 11-394-17



Mathieu
 11-398-17 - 11-398-20





Lichtenberg
11-400-20
20 cm



Crile
11-408-15
15 cm



Toennis
11-410-18
18 cm

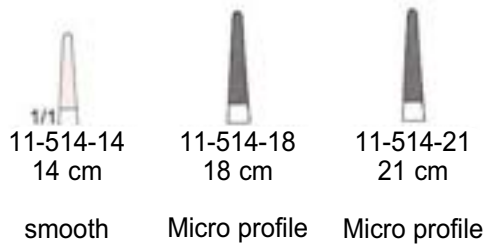


Dietrich
 11-510-16 - 11-510-26

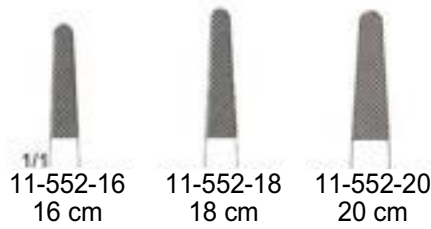
Micro profile



Castroviejo
 11-514-14 - 11-515-21

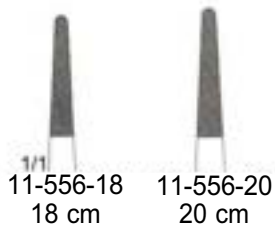






Normal profile

Mayo - Hegar
11-552-16 - 11-552-30



Mini profile

De Bakey
11-556-18 - 11-556-37



Mini profile

Martin
11-558-15 - 11-558-20



Mini profile

Baby Crile - Wood
 11-600-15
 15 cm



smooth

Crile - Wood
 11-602-15
 15 cm



Mini profile

Crile - Wood
 11-604-15
 15 cm



Olsen - Hegar
 11-610-14 - 11-610-18

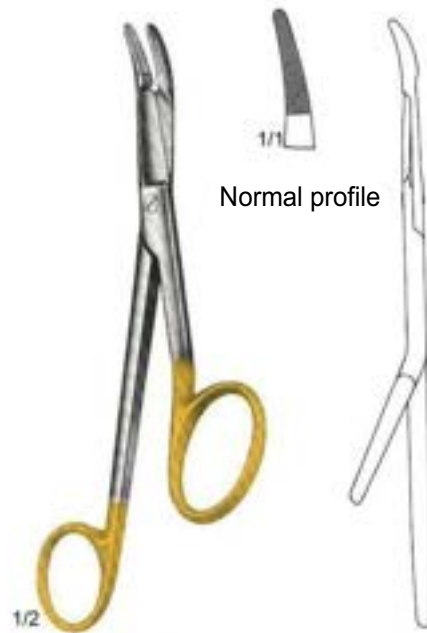


Normal profile

11-610-14
 14 cm

11-610-17
 17 cm

11-610-18
 18 cm



Normal profile

Gillies
 11-615-16
 16 cm



Mathieu
 11-630-14 - 11-630-20



Normal profile



Mathieu
 11-632-17 - 11-632-20



Normal profile



Mathieu - Delicate
 11-634-14 - 11-634-20



Normal profile

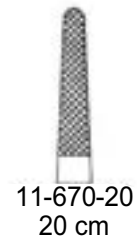
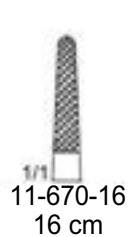




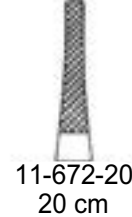
Langenbeck
 11-670-16 - 11-670-20

Langenbeck - Delicate
 11-672-18 - 11-672-20

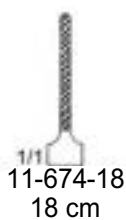
Langenbeck - Ryder
 11-674-18 - 11-674-20



Normal profile

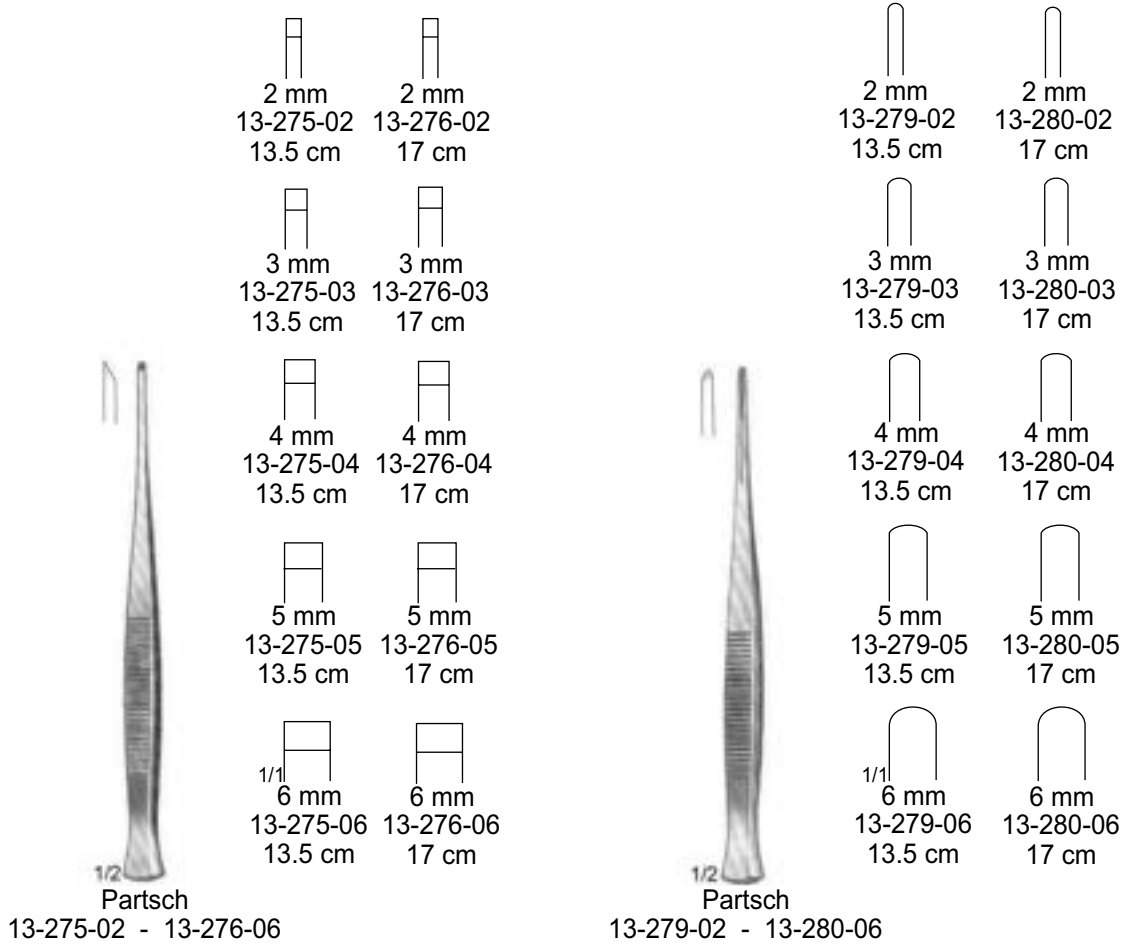


Normal profile

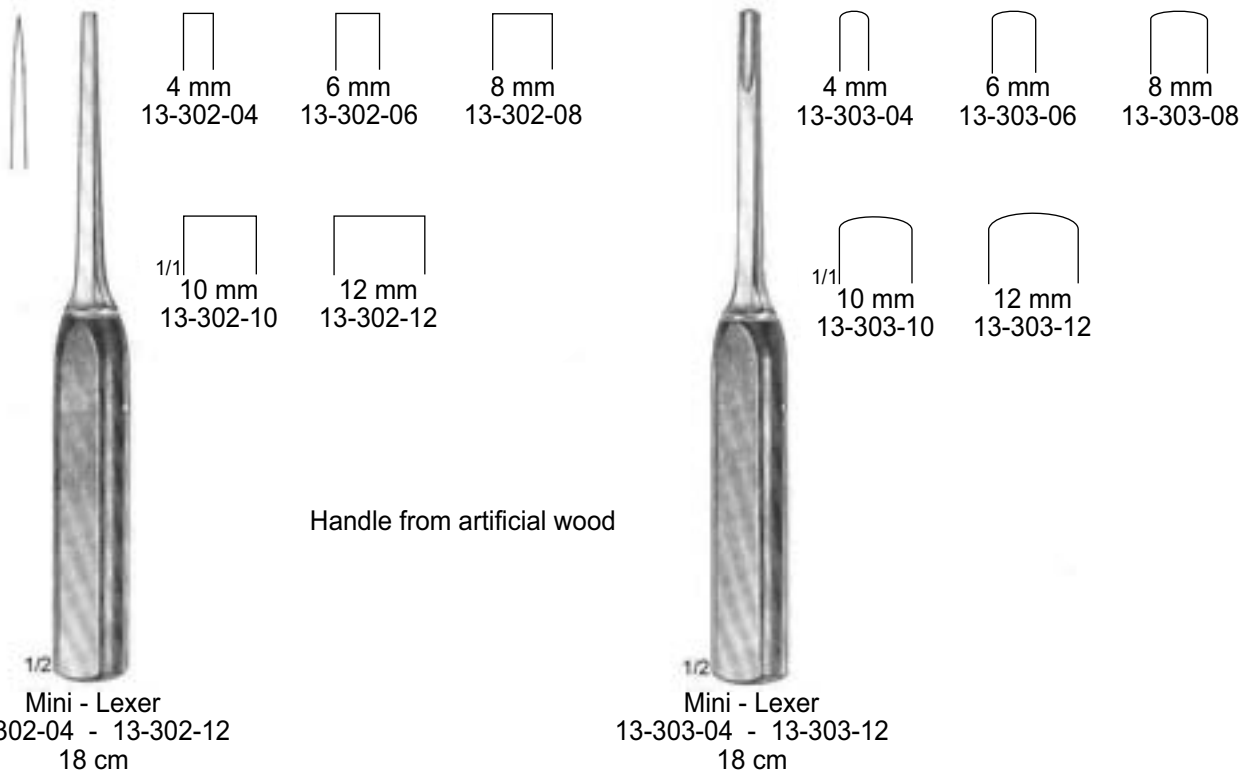


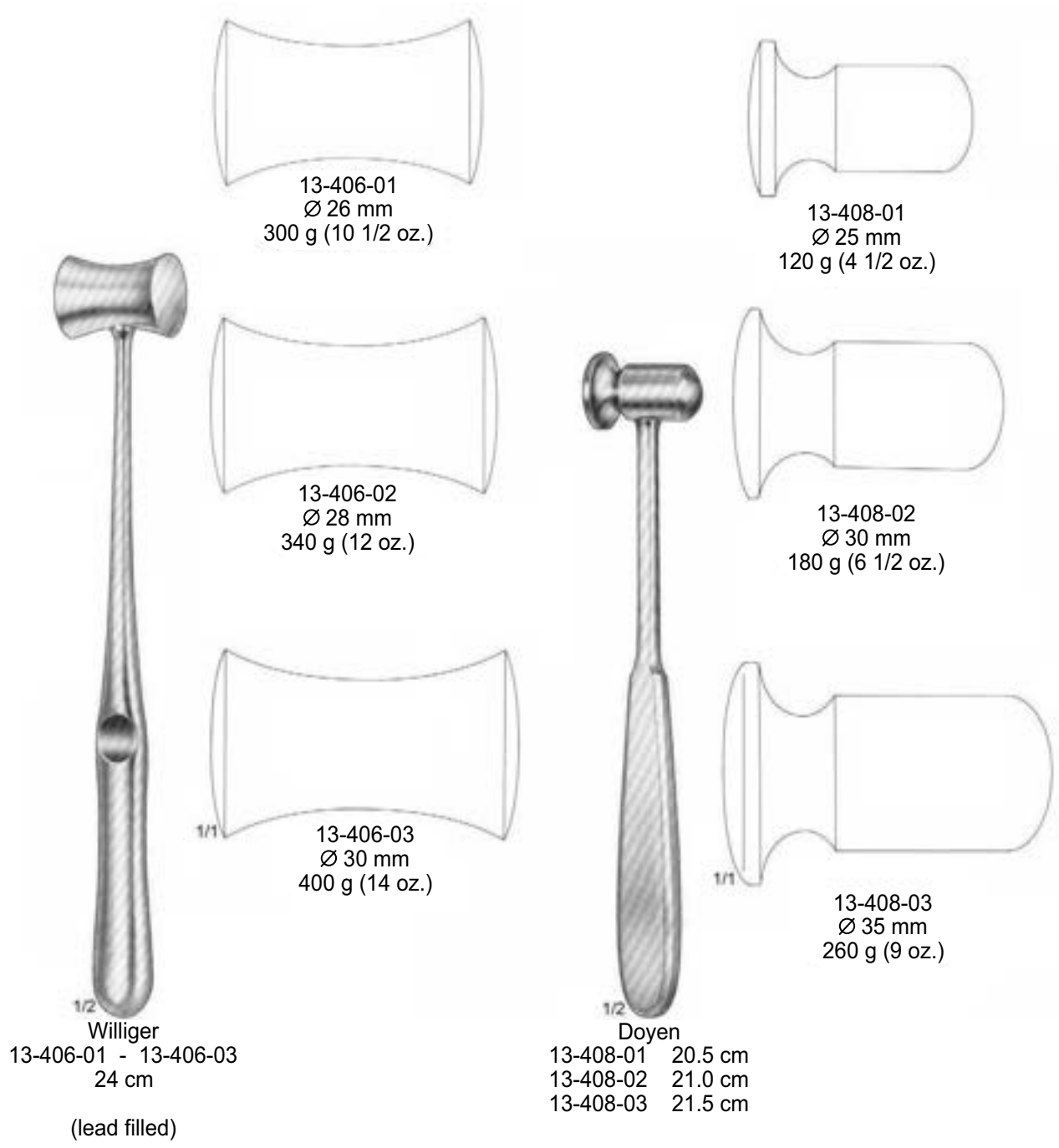
Mini profile

13





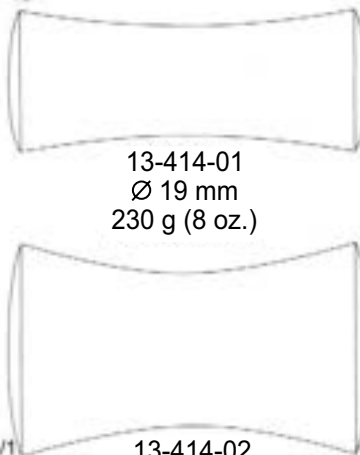






Ø 30 mm
 220 g (7 3/4 oz.)

1/2
 Collin
 13-410-20
 20 cm



13-414-01
 Ø 19 mm
 230 g (8 oz.)

13-414-02
 Ø 25 mm
 260 g (9 oz.)

1/2
 Lucae
 13-414-01 - 13-414-02
 19 cm



Ø 20 mm
 140 g (5 oz.)

1/2
 Williger
 13-416-16
 16.5 cm

Handle from artificial wood

Fig. 0000
13-490-40

Fig. 2
13-490-02

Fig. 000
13-490-30

Fig. 3
13-490-03

Fig. 00
13-490-20

Fig. 4
13-490-04

Fig. 0
13-490-10

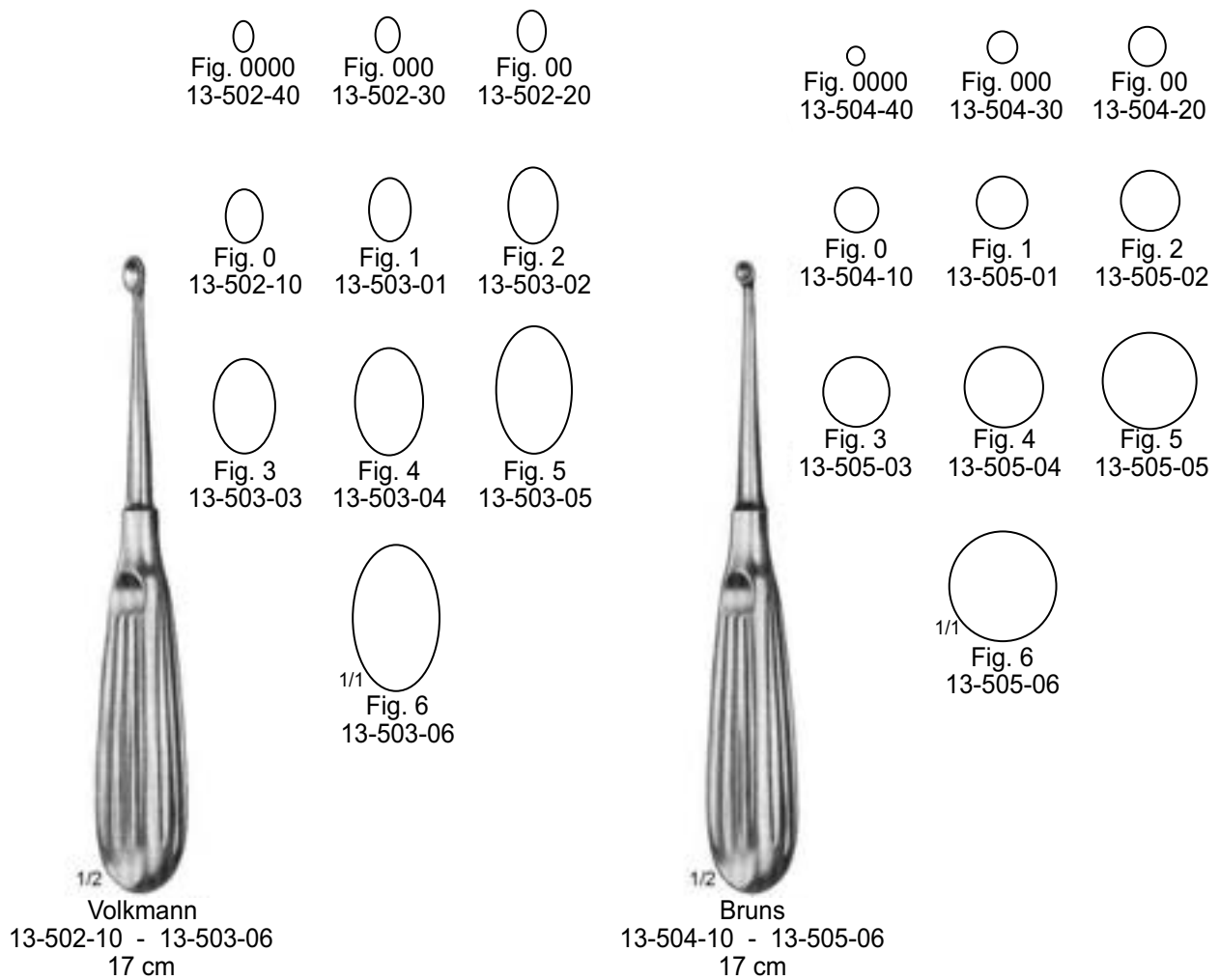
Fig. 5
13-490-05

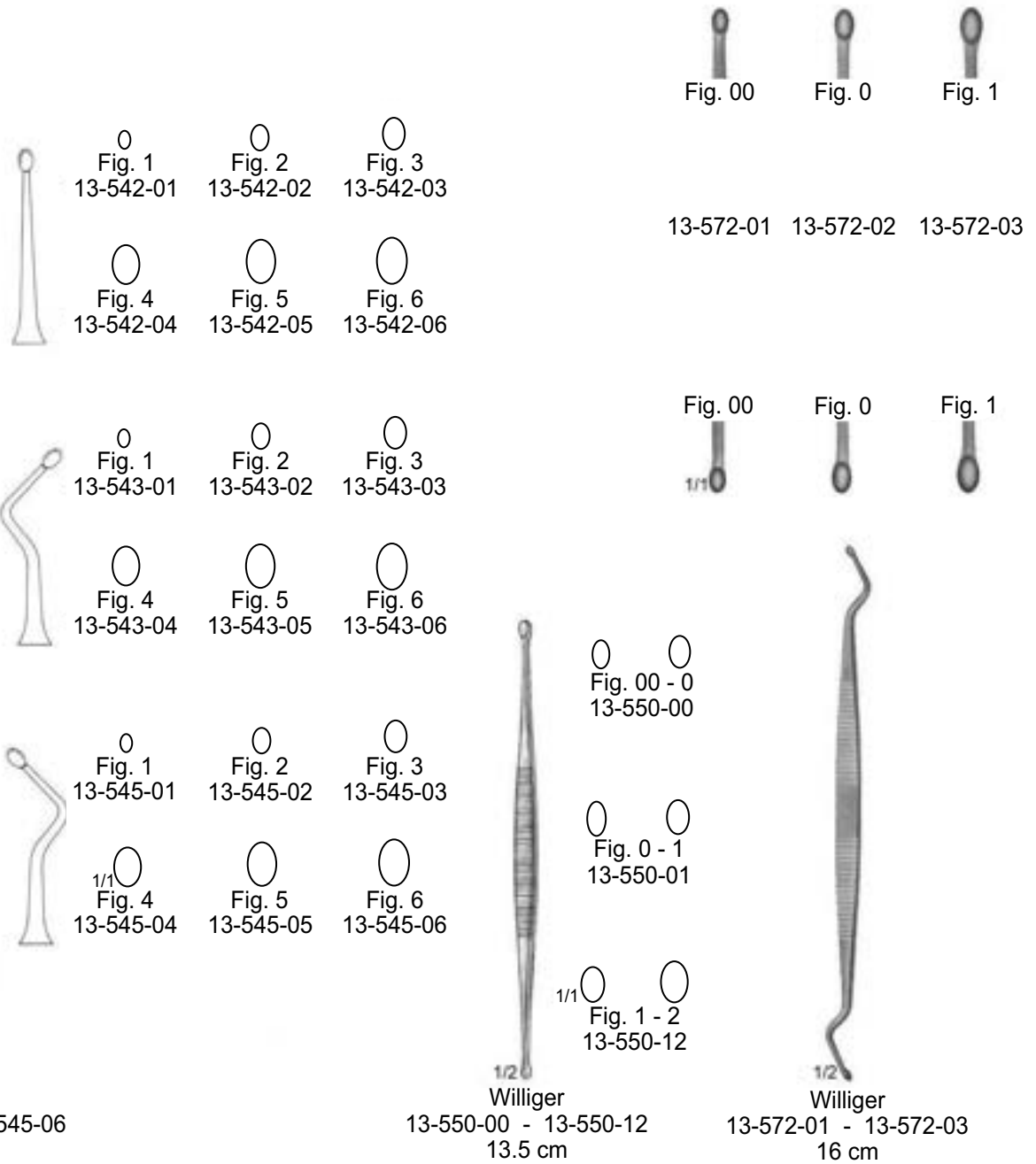
Fig. 1
13-490-01

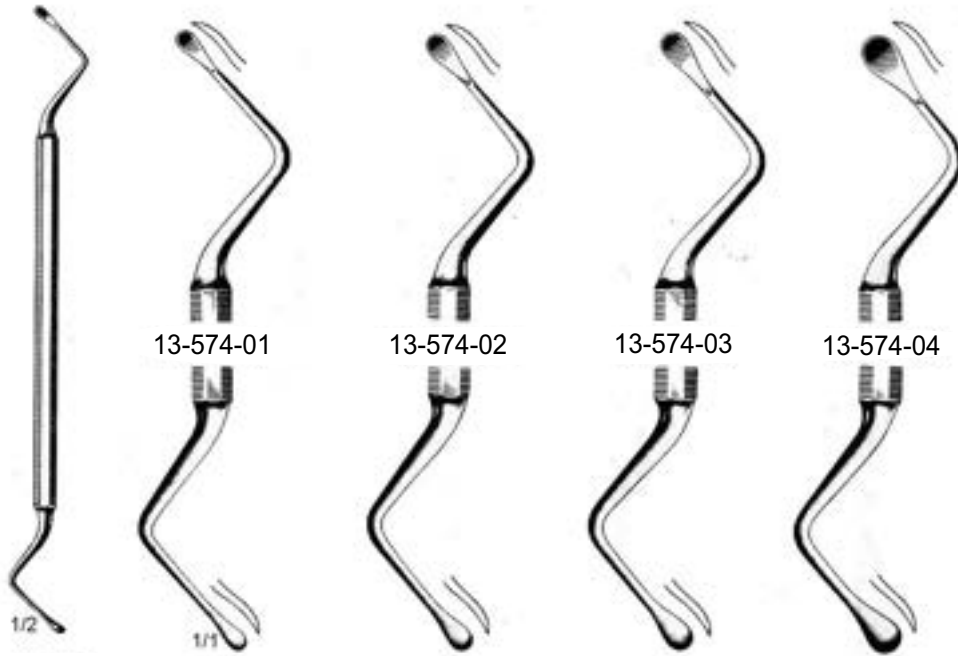
Fig. 6
13-490-06



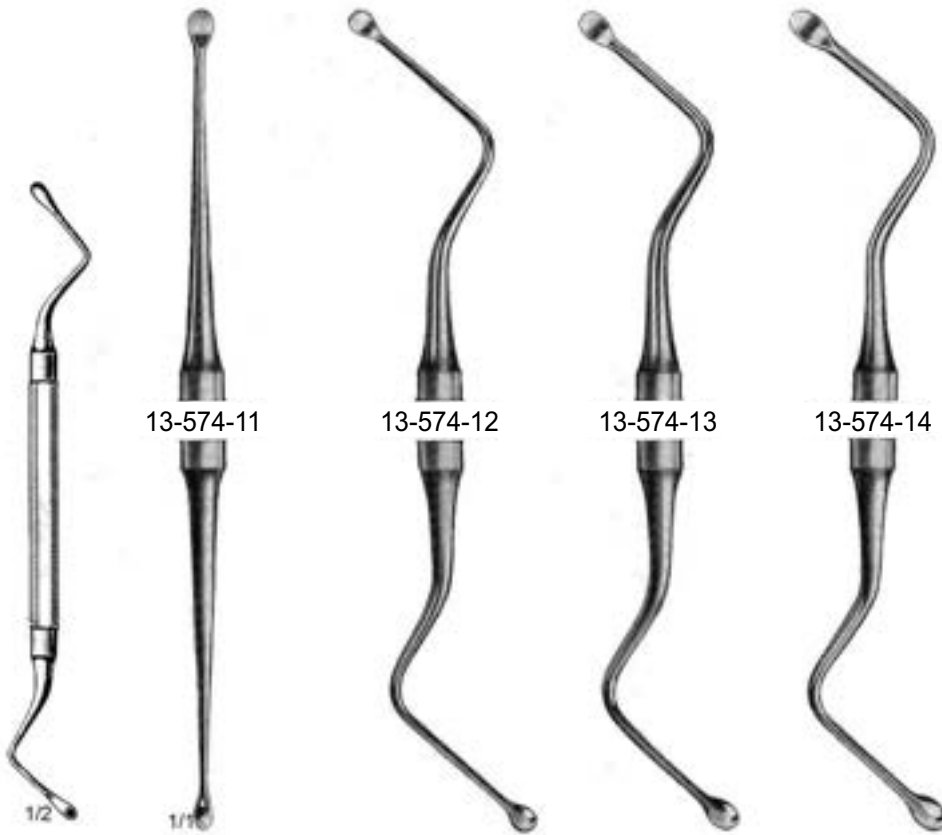
1/2
 Volkmann
 13-490-01 - 13-490-40
 17 cm



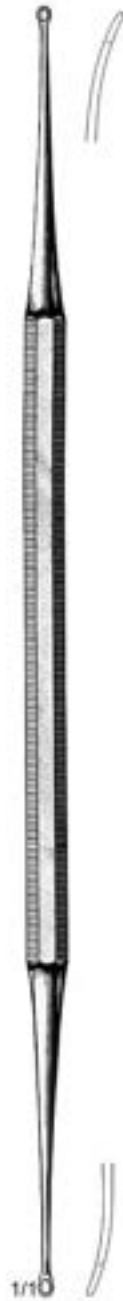




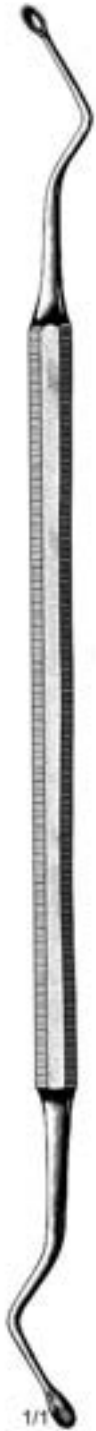
Lucas
 13-574-01 - 13-574-04
 16.5cm



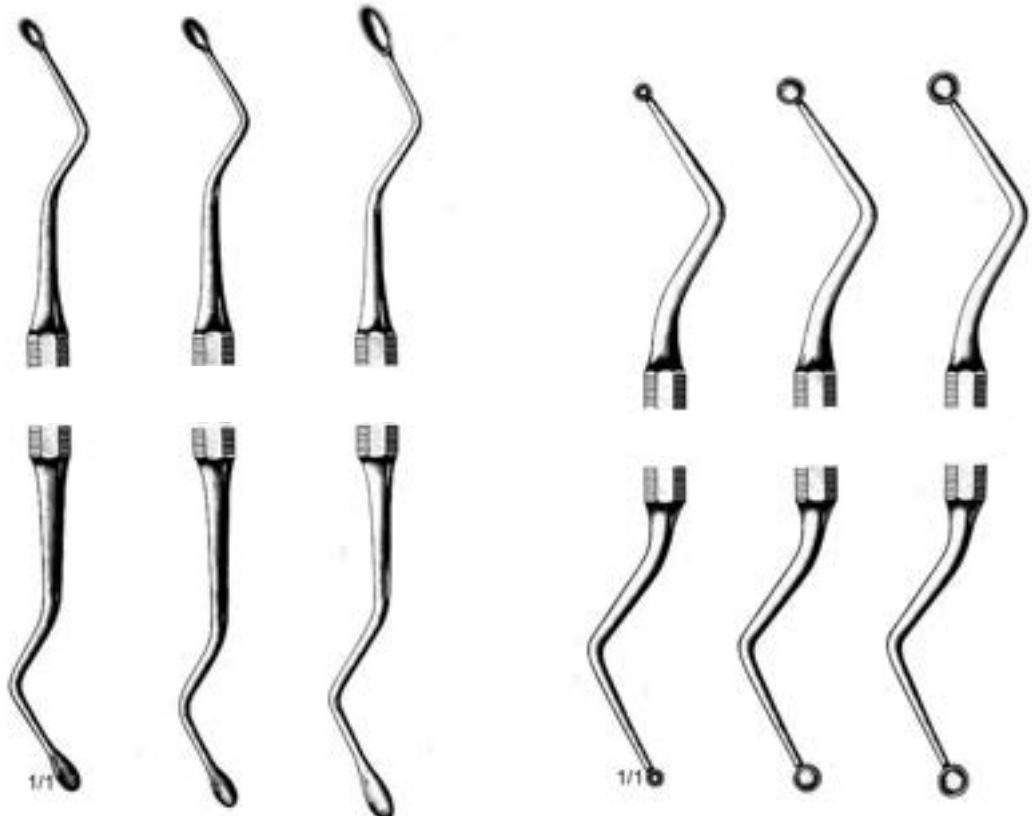
Miller - Colburn
 13-574-11 - 13-574-14
 16.5 cm



13-575-17
 17 cm



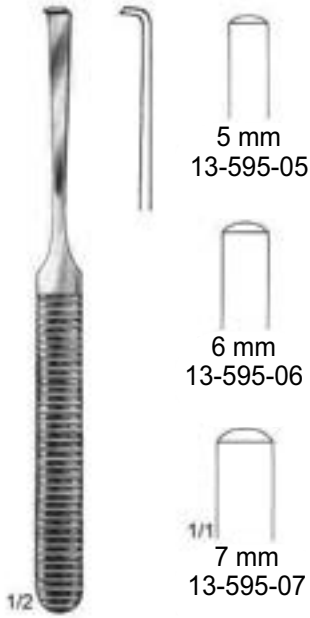
Hemingway
 13-576-01 - 13-576-02 - 13-576-03



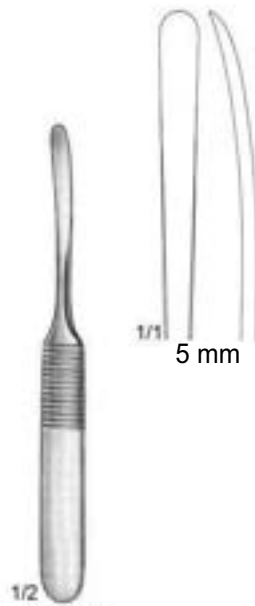
Hemingway - Mod. Martin
 13-576-11 - 13-576-12 - 13-576-13

Mod. Martin
 13-576-21 - 13-576-22 - 13-576-23

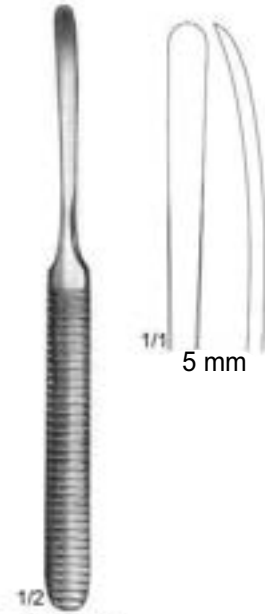
13-576-01 - 13-576-23
 18.5 cm



13-595-05 - 13-595-07
 16 cm



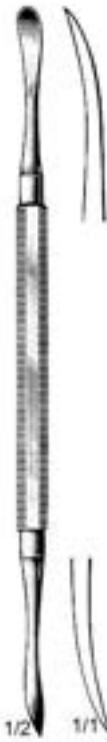
Williger
 13-611-13
 13 cm



Williger
 13-613-16
 16 cm



West
 13-617-01
 19 cm



Molt
 13-617-02
 19 cm



Ohl
 13-617-03
 19 cm

13-646-02
 13-648-02
 Ø 2 mm

13-646-03
 13-648-03
 Ø 3 mm

13-646-04
 13-648-04
 Ø 4 mm

13-646-05
 13-648-05
 Ø 5 mm

13-646-06
 13-648-06
 Ø 6 mm

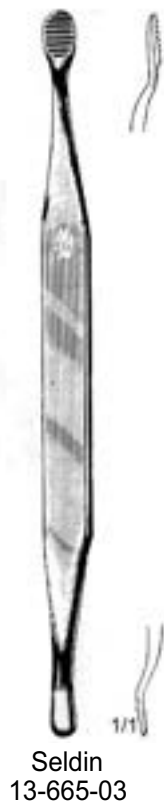
13-646-08
 13-648-08
 Ø 8 mm

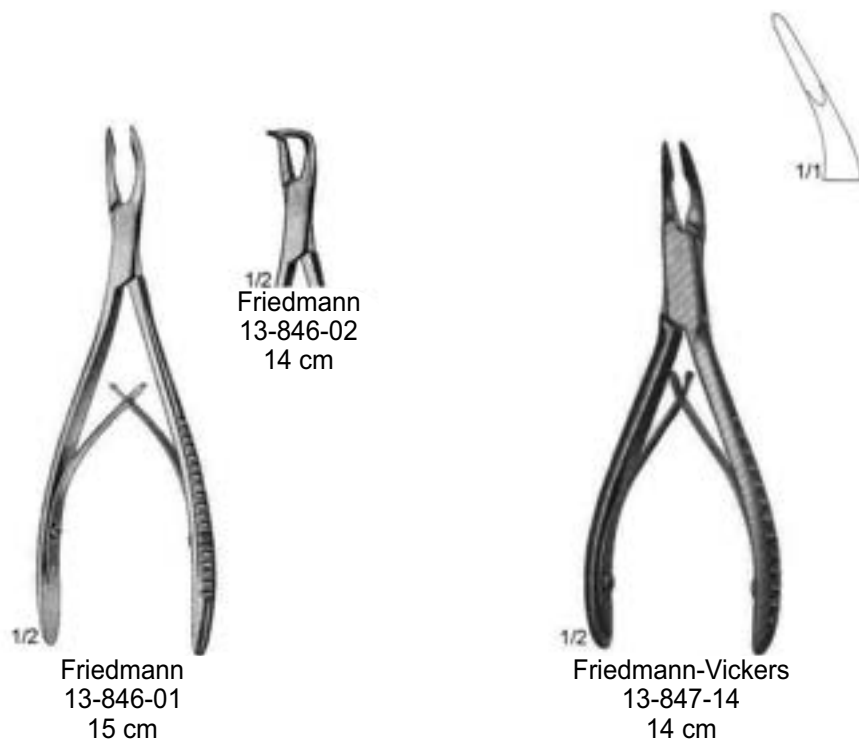
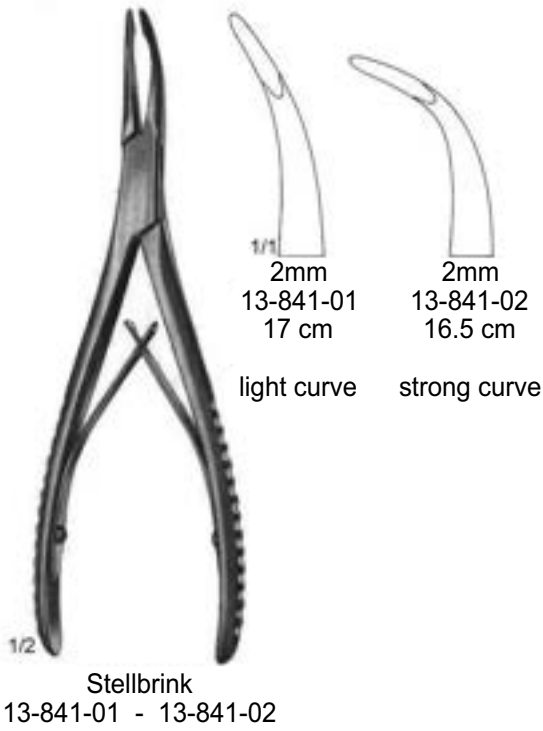
13-646-10
 13-648-10
 Ø 10 mm



13-646-02 - 13-646-10
 15.5 cm

13-648-02 - 13-648-10
 15.5 cm







Cohen
 13-849-14
 14 cm



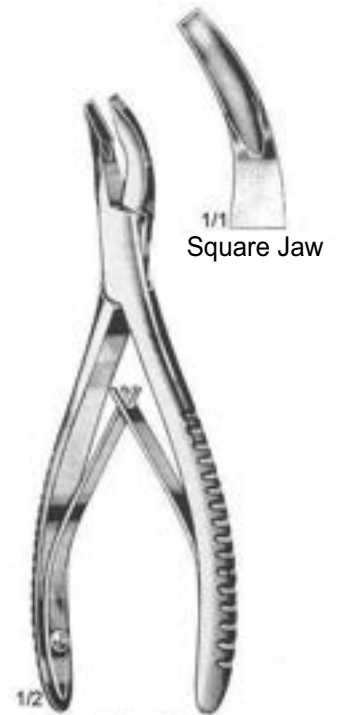
Cleveland
 13-851-14
 14 cm



Cleveland
 13-853-17
 17 cm



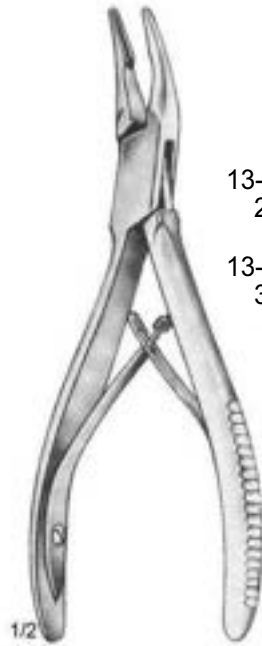
Mead
 13-855-16
 16.5 cm



Mead
 13-856-16
 16.5 cm



Beyer
 13-857-18
 18 cm



Beyer
 13-858-02 - 13-858-03
 17 cm



Hartmann
 13-859-18
 18.5 cm



Blumenthal
 13-866-15 - 13-869-14



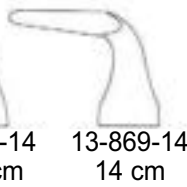
13-866-15
 15 cm

curve



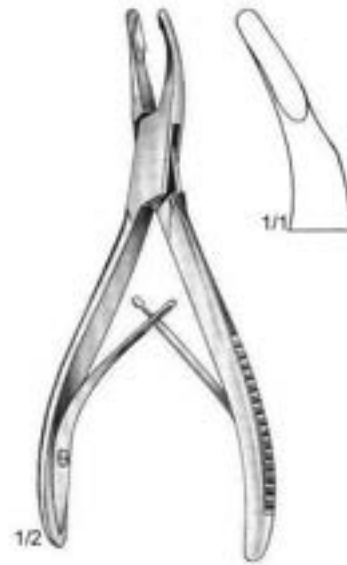
13-867-14
 14.5 cm

45°

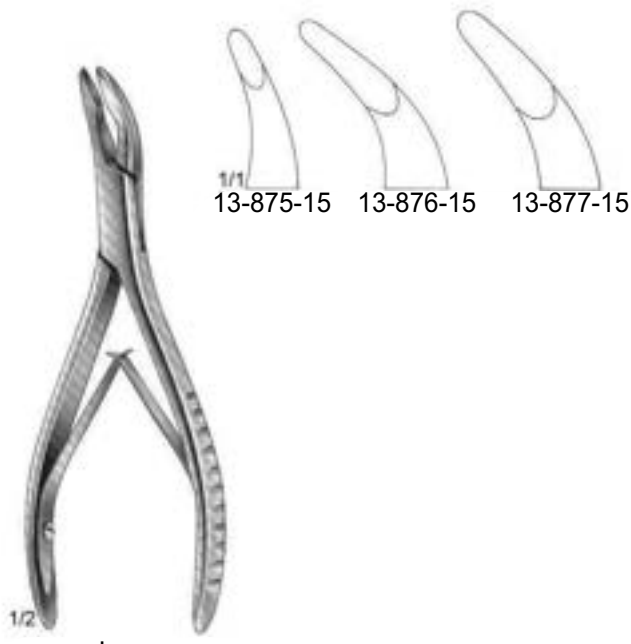


13-869-14
 14 cm

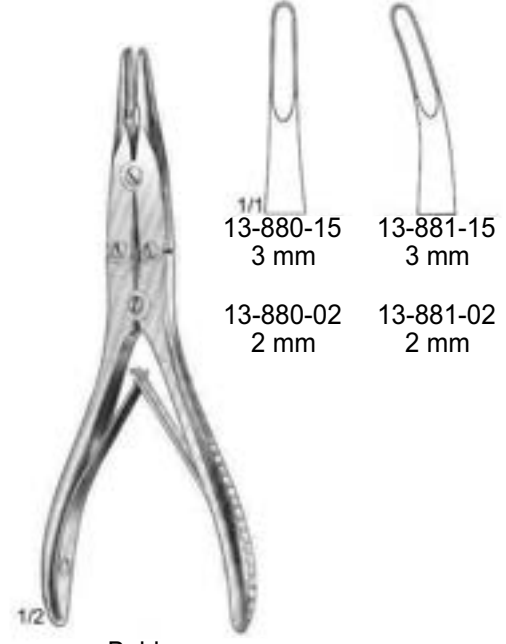
90°



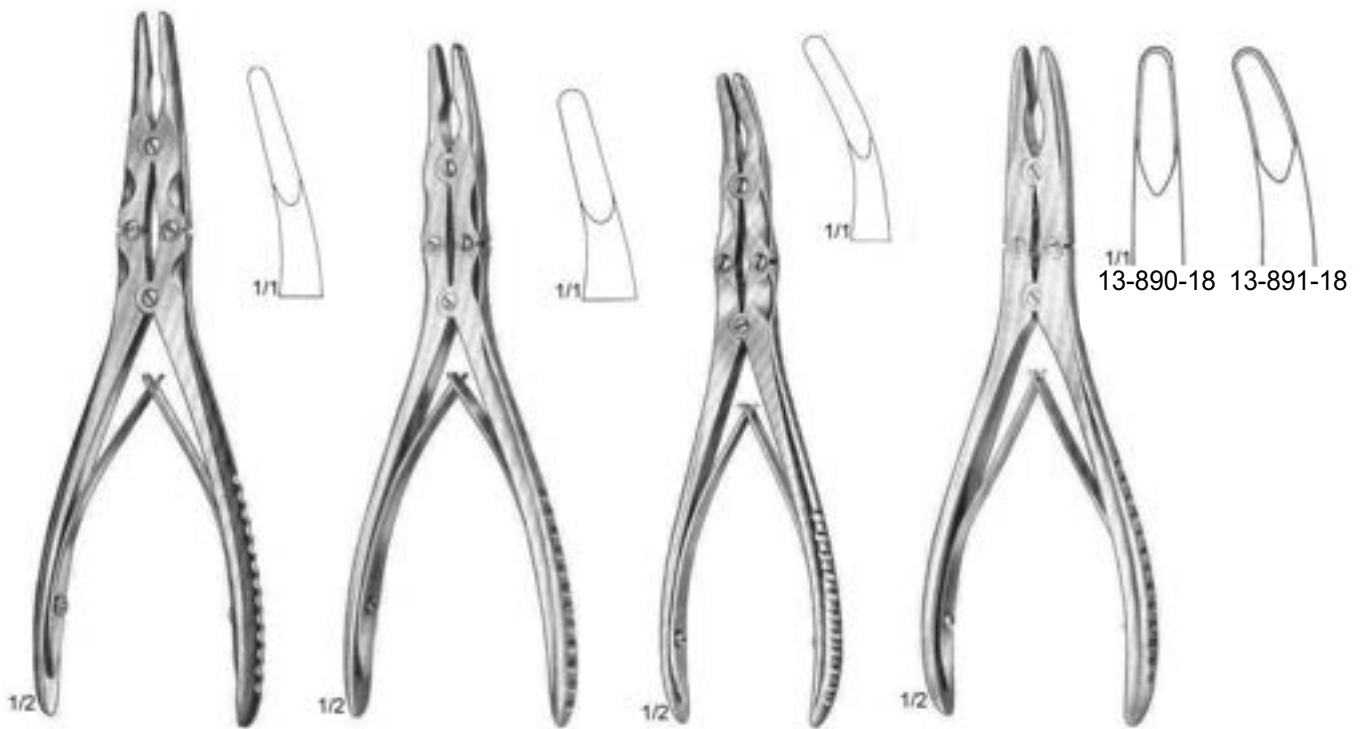
Universal
 13-870-13
 13.5 cm



Luer
 13-875-15 - 13-877-15
 15 cm



Bohler
 13-880-02 - 13-881-15
 15 cm

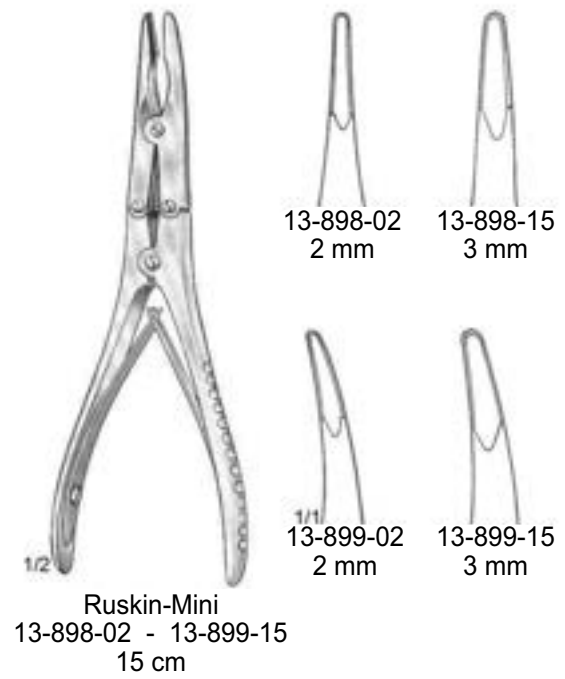


Beyer
 13-883-18
 18 cm

Zaufal-Jansen
 13-885-18
 18 cm

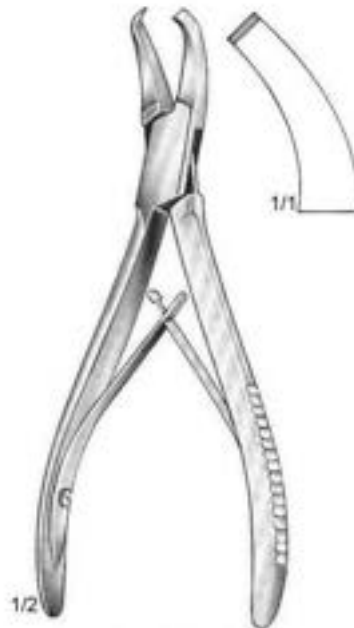
Mayfield
 13-887-17
 17 cm

Ruskin
 13-890-18 - 13-891-18
 18 cm





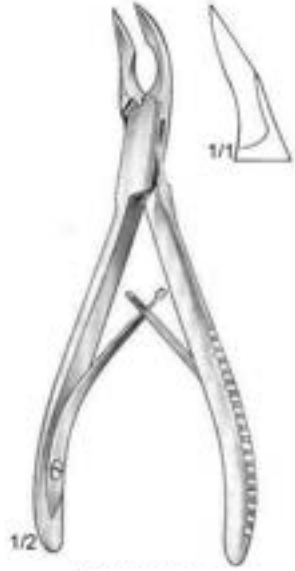
Cottle Kazanjian
13-940-19
19 cm



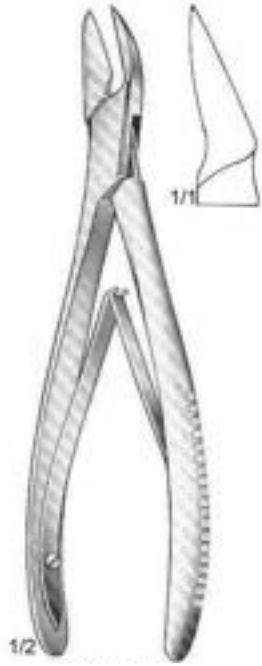
Cleveland-Gardner
13-941-16
16 cm



Littauer-Liston
13-948-15
15 cm



Cleveland
 13-951-15
 15 cm



Cleveland
 13-951-17
 17 cm



Kleinert-Kutz
 13-952-15 - 13-953-15
 15 cm



Ruskin-Liston
 13-954-18 - 13-955-18
 18 cm



13-954-18



13-955-18



McIndoe
 13-957-17
 17.5 cm



Bohler
 13-960-15
 15 cm



Bohler
 13-961-15
 15 cm

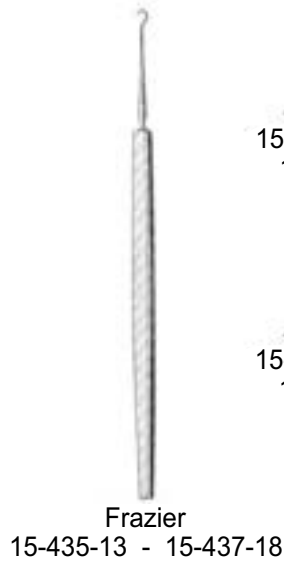


Walton-Liston
 13-962-15 - 13-963-15
 15 cm

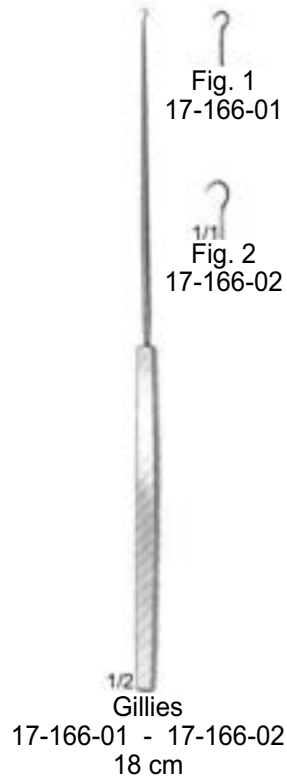


13-965-12
 12 cm

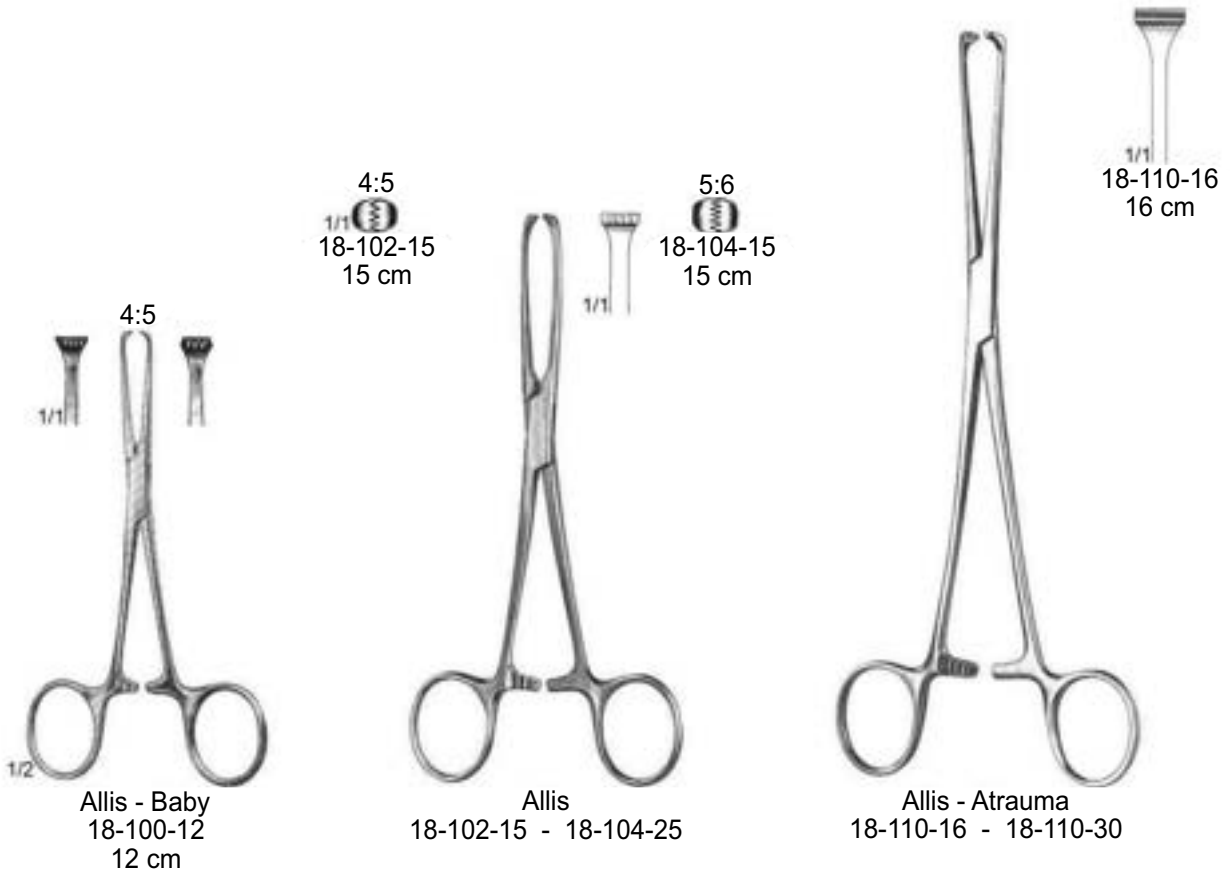
15



17



18





23



Fig. 1
23-688-01



Fig. 2
23-688-02



Fig. 3
23-688-03



Fig. 4
23-688-04



Fig. 5
23-688-05



1/1



1/2

Miller - Colburn
23-688-01 - 23-688-05
19 cm



Fig. 1
23-690-01



Fig. 2
23-690-02



Fig. 3
23-690-03



Fig. 4
23-690-04



Fig. 5
23-690-05



1/1



1/2

Miller - Colburn
23-690-01 - 23-690-05
19 cm

24



1/2
Heister
24-100-13
13 cm



1/2
Molt
24-141-11
11 cm



1/2
Molt
24-141-14
14 cm



1/2
Denhart
24-147-12
12 cm



Roser - Konig
24-149-16 16 cm
24-149-20 20 cm



24-174-10
Gag only

1/2
Kilner - Doughty
24-174-00

complete



1/2
Fig. 1
24-174-01
65 x 28 mm



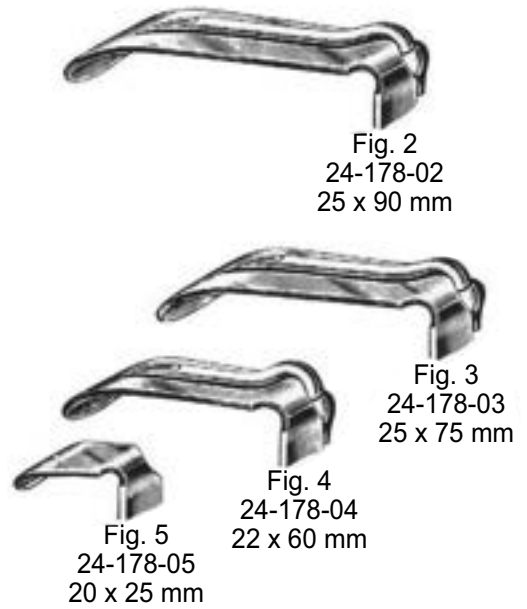
Fig. 2
24-174-02
75 x 32 mm

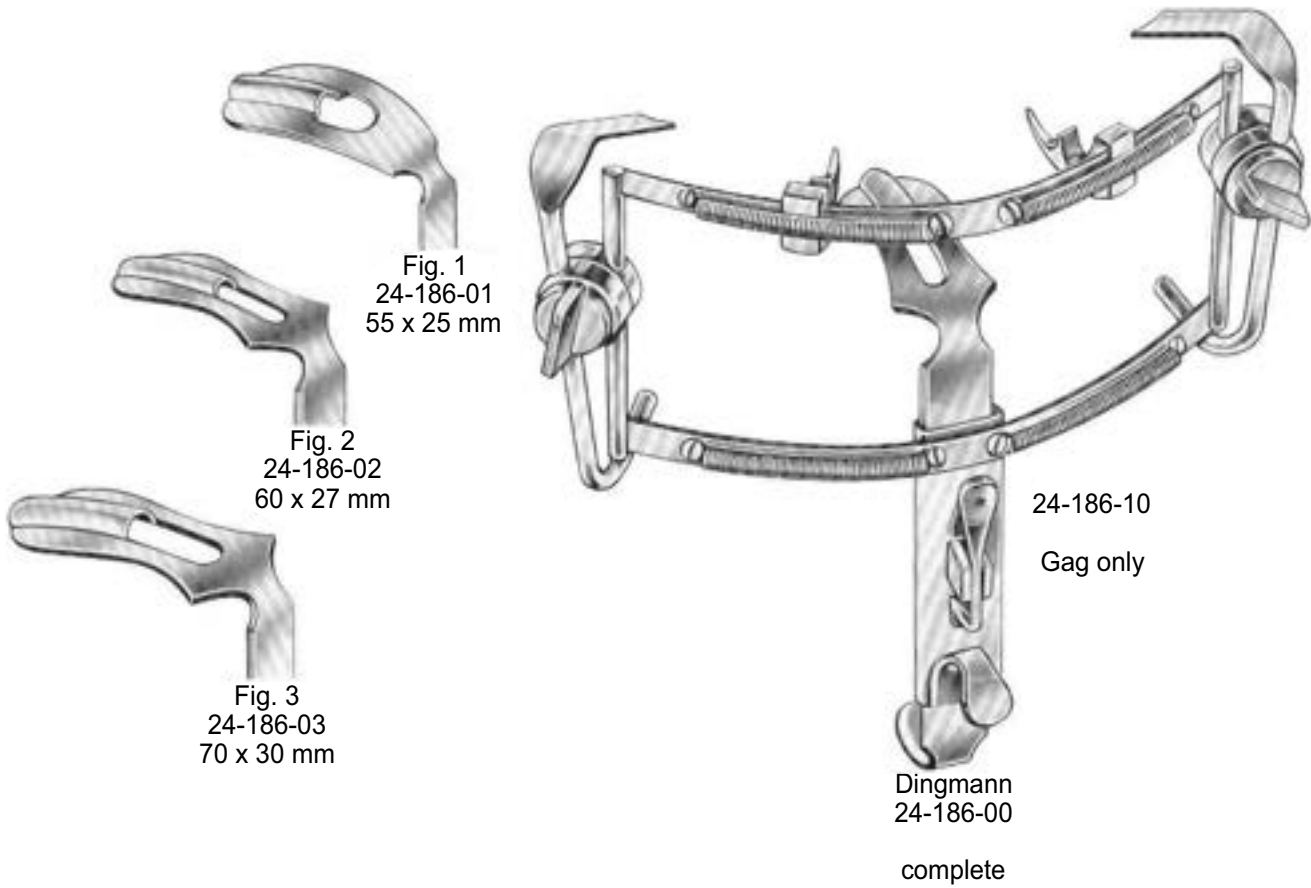


Fig. 3
24-174-03
80 x 37 mm



24-174-04





Modell Wurzburg

24-190-01	Fig. 1	66 x 28 mm
24-190-02	Fig. 2	75 x 32 mm
24-190-03	Fig. 3	83 x 34 mm
24-190-04	Fig. 4	93 x 37 mm
24-190-05	Fig. 5	100 x 38 mm

chest support for mouth gag



Negus
24-196-00



Jennings
24-250-09
24-250-11
24-250-13
24-250-15

9 cm
11 cm
13 cm
15 cm

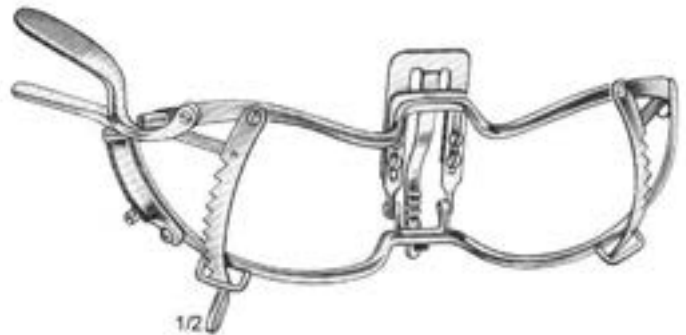


Seemann - Seiffert
24-254-09
24-254-11
24-254-13
24-254-15



Whitehead
24-260-09
24-260-11
24-260-13
24-260-15

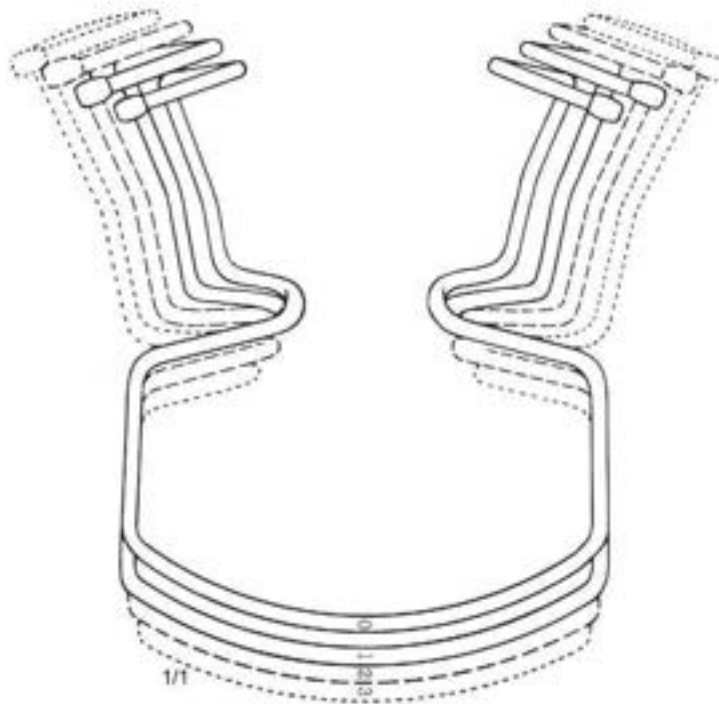
9 cm
11 cm
13 cm
15 cm



Whitehead
24-264-09
24-264-11
24-264-13
24-264-15



Oringer
 24-290-00 - 24-290-13



- 24-290-00 Fig. 0 9.5 cm
- 24-290-01 Fig. 1 10.0 cm
- 24-290-02 Fig. 2 10.5 cm
- 24-290-03 Fig. 3 11.0 cm

24-290-13 Set (Fig. 1 - 3)



1/2
Simplex
24-301-11
11 cm



Stemberg
24-303-14 14 cm
24-303-16 16 cm
24-303-18 18 cm



Stemberg
24-305-12 12 cm
24-305-14 14 cm
24-305-16 16 cm



1/2
Mod. Martin
24-309-19
19 cm



1/2
Mod. Martin
24-311-21
21 cm



1/2
Bishop
24-315-13
13 cm

72 x 23 mm



1/2
 Hartmann
 24-321-15
 15 cm

88 x 25 mm



1/2
 Tobold
 24-325-14
 14.5 cm

85 x 24 mm



1/2
 Tobold
 24-329-14
 14.5 cm



1/2
 Andrew
 24-333-11
 11 cm



1/2
 Wieder
 24-337-01 - 24-337-02



1/2
 24-337-01
 14 cm



1/2
 24-337-02
 15 cm



1/2
Moritz - Schmidt
24-361-19
19 cm



1/2
24-363-14
14.5 cm



1/2
Standard
24-365-14
14.5 cm



Doyen
24-367-13 13 cm
24-367-16 16 cm



1/2
Univ. Minnesota
24-369-14
14 cm



1/2
Kroenig
24-371-15
15 cm



1/2
Mayo
24-375-17
17 cm



18 mm
1/2
24-379-18
18 cm





24-415-20



24-415-10



24-415-00





Collin
24-450-17
17 cm



Guy
24-458-19
19 cm

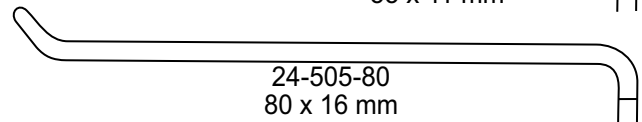
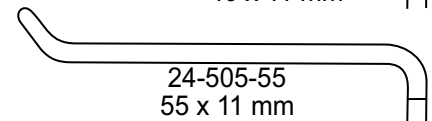
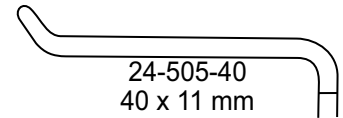
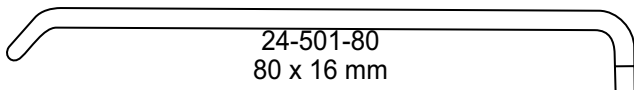
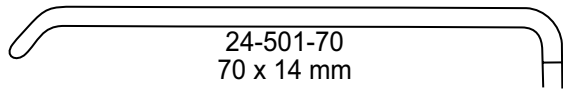
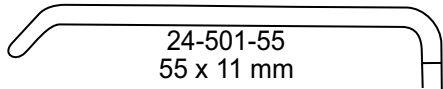
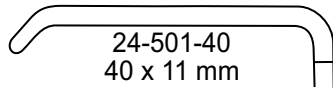
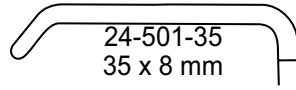
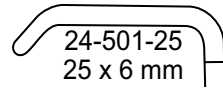


Young
24-465-17
17 cm

rubber inserts



23 x 15 mm
pair

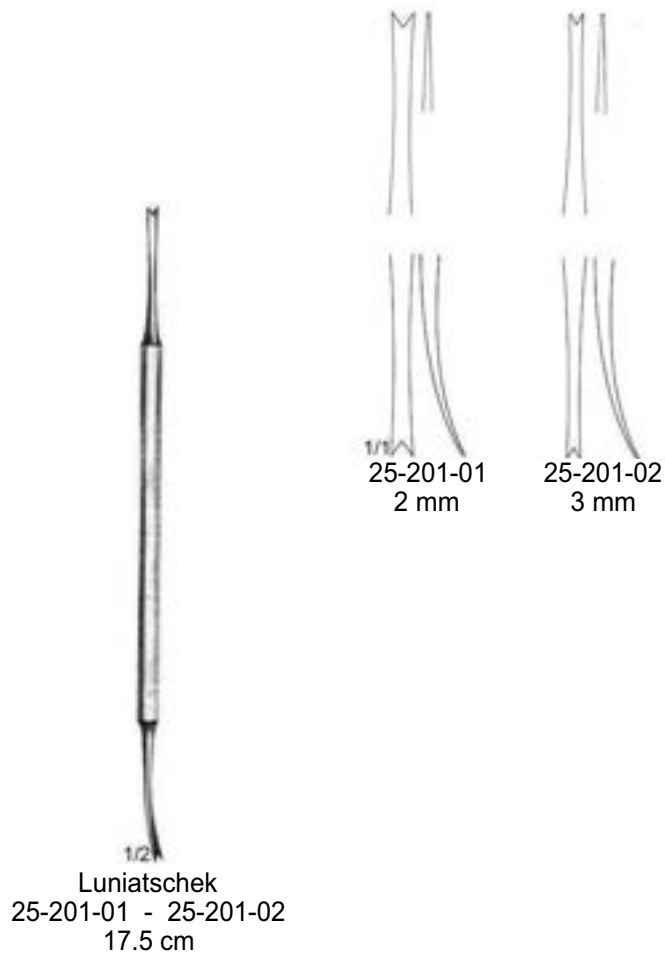


Obwegeser
24-501-25 - 24-501-80
21.5 cm

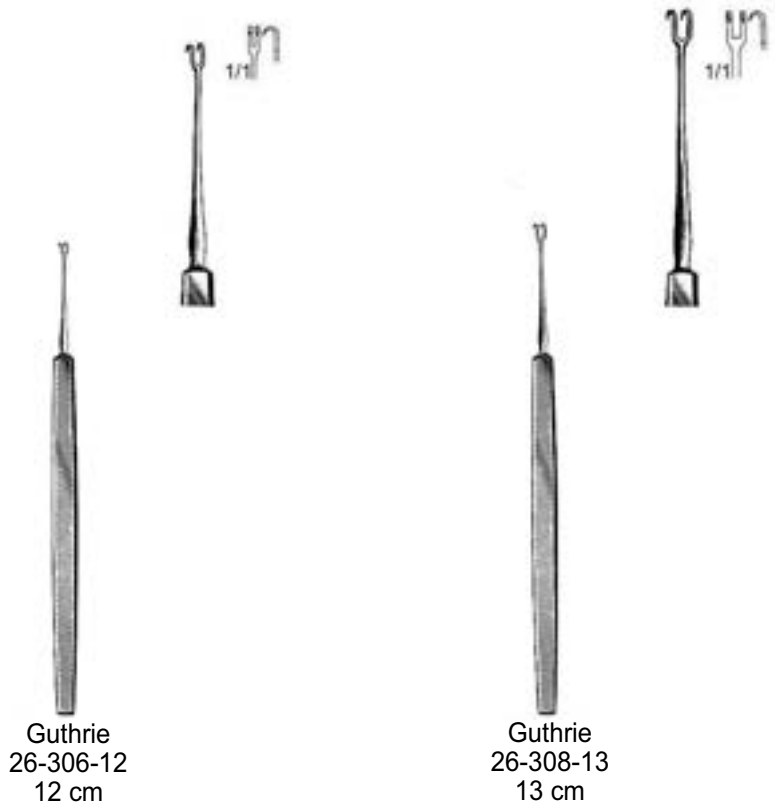


Obwegeser
24-505-40 - 24-505-80
22 cm

25



26



27

Fig.	00	0	1	2	3	4	5	6	7	8
Ø mm	0.7	0.8	0.9	1.1	1.3	1.4	1.5	1.6	1.8	1.9



Fish
 27-356-14 14.5 cm
 27-356-18 18.0 cm
 Ø 2 mm



Bowman
 27-360-00 Fig. 0/0
 27-360-11 Fig. 1/1
 27-360-22 Fig. 2/2
 27-360-33 Fig. 3/3
 27-360-44 Fig. 4/4
 27-360-55 Fig. 5/5
 27-360-66 Fig. 6/6
 27-360-77 Fig. 7/7
 27-360-88 Fig. 8/8



Bowman
 27-364-00 Fig. 00/0
 27-364-01 Fig. 0/1
 27-364-12 Fig. 1/2
 27-364-23 Fig. 2/3
 27-364-34 Fig. 3/4
 27-364-45 Fig. 4/5
 27-364-56 Fig. 5/6
 27-364-67 Fig. 6/7
 27-364-78 Fig. 7/8



Bowman
 27-366-00 Fig. 00/0
 27-366-01 Fig. 0/1
 27-366-12 Fig. 1/2
 27-366-23 Fig. 2/3
 27-366-34 Fig. 3/4
 27-366-45 Fig. 4/5
 27-366-56 Fig. 5/6
 27-366-67 Fig. 6/7
 27-366-78 Fig. 7/8

29



29-100-10
10 cm



29-105-10
10 cm



29-120-14
14 cm



29-124-14 14 cm
29-124-16 16 cm



Turnbull
29-128-11 11.5 cm
29-128-13 13.0 cm



29-132-13
13 cm



29-136-12
12 cm



29-140-11 11 cm
29-140-13 13 cm
29-140-15 15 cm



29-144-11 11 cm
 29-144-13 13 cm



29-148-10
 10.5 cm



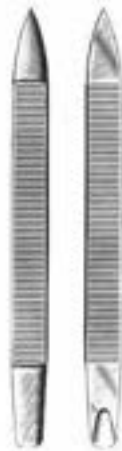
29-160-10
 10.5 cm



29-161-10
 10.5 cm



29-170-11
 11 cm



29-172-10 10 cm
 29-172-12 12 cm



29-174-11
 11 cm



29-176-16
 16 cm



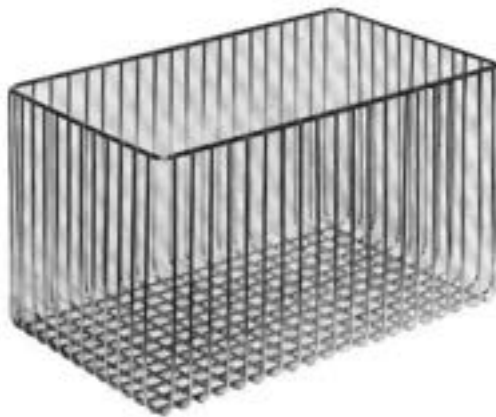
Cohen
29-178-01
13 cm



Cohen
29-178-02
13 cm



29-180-00
200 x 200 x 100 mm



29-184-25
250 x 150 x 150 mm



29-188-11
110 x 75 x 13mm



29-190-16 16 cm
29-190-24 24 cm



29-196-20 20 cm
29-196-28 28 cm



29-197-20 20 cm
29-197-28 28 cm



29-206-20
20 cm



Cheatle
29-211-27
27 cm



29-215-20 20 cm
29-215-30 30 cm



Rogge
29-219-23
23 cm



29-230-24
24 cm



Ulleval
29-235-24
24 cm



Harrison
29-239-30
30 cm



29-310-75
120 x 65 x 13 mm

Box (without Bulldog clamps, without Silicone tape)



29-314-75
120 x 65 x 13 mm

Box with support (without Bulldog clamps)



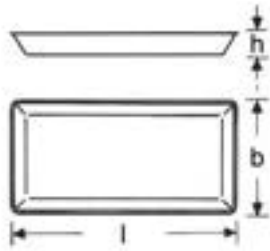
29-318-75
120 x 65 x 13 mm

Box with support (without instruments)



29-322-12
120 x 120 mm

Storing cup for micro instruments



sizes in mm

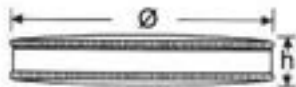


29-330-50
 29-330-65
 29-330-75

50 x 25 x 4.5 mm
 65 x 42 x 8.0 mm
 75 x 25 x 4.5 mm



29-332-50
 29-332-65
 29-332-75



29-338-65
 Ø = 65 mm
 h = 15 mm

complete

29-339-65
 Ø = 62 mm
 h = 13 mm

insert only



29-342-13
 135 x 100 x 25 mm



Sauerbruch
29-354-20
200 x 100 x 17 mm



Sauerbruch
29-356-20
200 x 100 x 17 mm



29-360-01
150 x 95 x 13 mm



29-360-02
150 x 95 x 13 mm



29-360-03
150 x 95 x 13 mm



29-360-04
150 x 95 x 13 mm



29-362-01
150 x 95 x 13 mm



29-362-02
150 x 95 x 13 mm



29-364-01
150 x 95 x 11 mm



lid with knob 29-372-01
 200 x 100 x 40 mm

29-372-02
 200 x 100 x 40 mm

lid without knob 29-372-11
 200 x 100 x 40 mm

29-372-12
 200 x 100 x 40 mm

sizes in mm (x h)



lid with knob 29-374-01
 135 x 40 mm

29-374-02
 135 x 40 mm

lid without knob 29-374-11
 135 x 40 mm

29-374-12
 135 x 40 mm



sizes in mm (l x b x h)	Containers
230 x 120 x 50	29-380-23
250 x 125 x 50	29-380-25
300 x 150 x 50	29-380-30
350 x 175 x 50	29-380-35
400 x 200 x 50	29-380-40
300 x 150 x 75	29-382-30
350 x 175 x 75	29-382-35
400 x 200 x 75	29-382-40



29-390-50 300 x 150 x 50 mm
29-390-65 300 x 150 x 65 mm
29-390-80 300 x 150 x 80 mm

All bottoms with filters

Table - top model



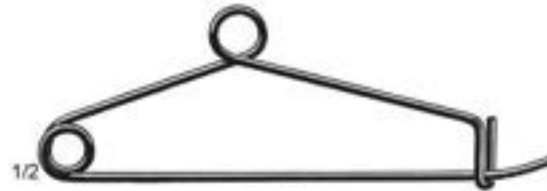
29-392-00



29-392-01



Mayo
29-410-14
14 cm



Mayo
29-414-14
14 cm



Bunt
29-418-12
12 cm

sizes in mm (l x b x h)



29-440-01	240 x 250 x 30
29-440-02	240 x 250 x 50
29-440-03	240 x 250 x 170
29-440-04	240 x 250 x 100
29-440-05	400 x 250 x 30
29-440-06	400 x 250 x 50
29-440-07	400 x 250 x 70
29-440-08	400 x 250 x 100
29-440-09	480 x 250 x 130
29-440-10	480 x 250 x 150
29-440-11	480 x 250 x 170
29-440-12	480 x 250 x 100
29-440-13	510 x 250 x 150
29-440-14	510 x 250 x 170
29-440-15	510 x 250 x 100
29-440-16	550 x 250 x 150
29-440-17	550 x 250 x 170
29-440-18	550 x 250 x 100



sizes in mm (l x b x h)

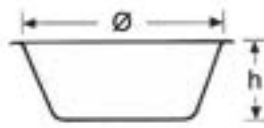
29-446-01	240 x 240 x 50
29-446-02	240 x 240 x 80
29-446-03	240 x 240 x 100
29-446-04	260 x 260 x 100
29-446-05	480 x 260 x 50
29-446-06	500 x 260 x 50
29-446-07	510 x 200 x 40
29-446-08	520 x 260 x 80
29-446-09	520 x 260 x 100



29-454-15
60 x 30 x 15 cm



29-454-30
60 x 30 x 30 cm



sizes in mm (Ø x h)

29-500-04	40 x 20
29-500-06	60 x 30
29-500-08	80 x 40
29-500-10	100 x 50
29-500-12	120 x 55
29-500-15	150 x 75
29-500-18	180 x 85
29-500-20	200 x 90
29-500-22	225 x 100
29-500-24	240 x 110
29-500-27	275 x 115
29-500-29	290 x 125
29-500-31	310 x 125
29-500-34	345 x 125
29-500-38	380 x 130



Ø mm

29-506-30	300 x 100
29-506-35	350 x 120



sizes in mm (Ø x h)

29-510-04	40 x 20
29-510-06	60 x 30
29-510-08	80 x 40
29-510-10	100 x 50
29-510-12	120 x 55
29-510-14	140 x 65
29-510-15	150 x 75
29-510-18	180 x 85



sizes in mm (Ø x h)

29-514-10	100 x 35
29-514-12	120 x 40
29-514-14	140 x 40
29-514-15	150 x 45
29-514-18	180 x 45

sizes in mm (Ø x h)



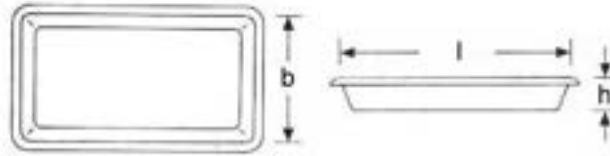
29-518-28
110 x 28



29-524-01
100 cc



29-526-02 0.25 l
 29-526-05 0.50 l
 29-526-10 1.00 l
 29-526-20 2.00 l



Available in different heights



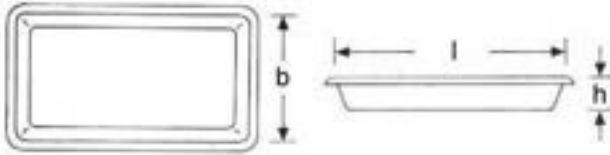
sizes in mm (l x b x h)

29-532-01	180 x 130 x 10
29-532-02	200 x 150 x 10
29-532-03	220 x 170 x 10
29-532-04	240 x 140 x 10
29-532-05	250 x 200 x 10
29-532-06	300 x 150 x 10
29-532-07	300 x 200 x 10
29-532-08	300 x 250 x 10
29-532-09	350 x 300 x 10
29-532-10	370 x 270 x 10
29-532-11	400 x 300 x 10
29-532-12	400 x 350 x 10
29-532-13	450 x 300 x 10
29-532-14	460 x 300 x 10
29-532-15	460 x 360 x 10
29-532-16	490 x 300 x 10
29-532-17	500 x 200 x 10

sizes in mm (l x b x h)

29-536-01	180 x 130 x 50
29-536-02	200 x 150 x 50
29-536-03	220 x 170 x 50
29-536-04	240 x 140 x 50
29-536-05	250 x 200 x 50
29-536-06	300 x 150 x 50
29-536-07	300 x 200 x 50
29-536-08	300 x 250 x 50
29-536-09	350 x 300 x 50
29-536-10	370 x 270 x 50
29-536-11	400 x 300 x 50
29-536-12	400 x 350 x 50
29-536-13	450 x 300 x 50
29-536-14	460 x 300 x 50
29-536-15	460 x 360 x 50
29-536-16	490 x 300 x 50
29-536-17	500 x 200 x 50



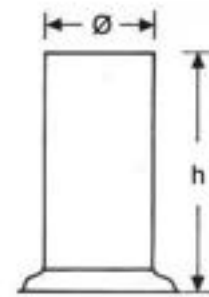


Available in different heights



sizes in mm (l x b x h)

29-540-01	180 x 130 x 30
29-540-02	200 x 150 x 30
29-540-03	220 x 170 x 30
29-540-04	240 x 140 x 30
29-540-05	250 x 200 x 30
29-540-06	300 x 150 x 30
29-540-07	300 x 200 x 30
29-540-08	300 x 250 x 30
29-540-09	350 x 300 x 30
29-540-10	370 x 270 x 30
29-540-11	400 x 300 x 30
29-540-12	400 x 350 x 30
29-540-13	450 x 300 x 30
29-540-14	460 x 300 x 30
29-540-15	460 x 360 x 30
29-540-16	490 x 300 x 30
29-540-17	500 x 200 x 30



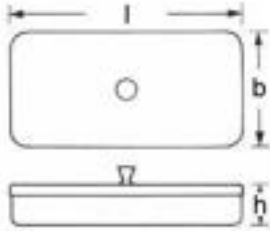
jar without lid

lid only

lid only with triangle hole

sizes in mm (Ø x h)

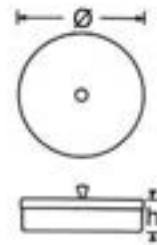
29-550-01	29-554-01	29-556-01	30 x 90
29-550-02	29-554-02	29-556-02	52 x 100
29-550-03	29-554-03	29-556-03	52 x 130
29-550-04	29-554-04	29-556-04	52 x 180
29-550-05	29-554-05	29-556-05	70 x 100
29-550-06	29-554-06	29-556-06	70 x 130
29-550-07	29-554-07	29-556-07	70 x 180
29-550-08	29-554-08	29-556-08	70 x 200
29-550-09	29-554-09	29-556-09	100 x 180
29-550-10	29-554-10	29-556-10	100 x 200
29-550-11	29-554-11	29-556-11	125 x 175



lid with knob	lid without knob	sizes in mm (l x b x h)
29-560-01	29-562-01	150 x 65 x 25
29-560-02	29-562-02	170 x 70 x 30
29-560-03	29-562-03	180 x 80 x 40
29-560-04	29-562-04	180 x 120 x 60
29-560-05	29-562-05	200 x 100 x 40
29-560-06	29-562-06	200 x 100 x 60
29-560-07	29-562-07	220 x 120 x 60
29-560-08	29-562-08	250 x 125 x 45
29-560-09	29-562-09	300 x 120 x 60
29-560-10	29-562-10	300 x 150 x 50
29-560-11	29-562-11	320 x 165 x 55
29-560-12	29-562-12	340 x 165 x 75
29-560-13	29-562-13	400 x 160 x 75
29-560-14	29-562-14	500 x 200 x 75



sizes in mm (l x b x h)	
29-566-01	150 x 65 x 25
29-566-02	170 x 70 x 30
29-566-03	180 x 80 x 40
29-566-04	180 x 120 x 60
29-566-05	200 x 100 x 40
29-566-06	200 x 100 x 60
29-566-07	220 x 120 x 60
29-566-08	250 x 125 x 45
29-566-09	300 x 120 x 60
29-566-10	300 x 150 x 50
29-566-11	320 x 165 x 55
29-566-12	340 x 165 x 75
29-566-13	400 x 160 x 75
29-566-14	500 x 200 x 75



lid with knob	lid without knob	sizes in mm (Ø x h)
29-574-01	29-576-01	80 x 60
29-574-02	29-576-02	80 x 80
29-574-03	29-576-03	100 x 60
29-574-04	29-576-04	120 x 80
29-574-05	29-576-05	100 x 100
29-574-06	29-576-06	120 x 120
29-574-07	29-576-07	150 x 150
29-574-08	29-576-08	180 x 180
29-574-09	29-576-09	200 x 200
29-574-10	29-576-10	250 x 250



29-580-01 025 cc
 29-580-02 050 cc
 29-580-03 075 cc
 29-580-04 100 cc



29-586-15
 15 cc

sizes in mm (Ø x h)



with lid

29-590-10 100 x 20



without lid

29-592-09 96 x 20



29-593-10



29-650-25
Ø 180 x 125 mm



29-652-60
Ø 100 x 60 mm



29-654-95
Ø 120 x 95 mm



29-656-50
Ø 100 x 50 mm



29-658-50
Ø 100 x 50 mm



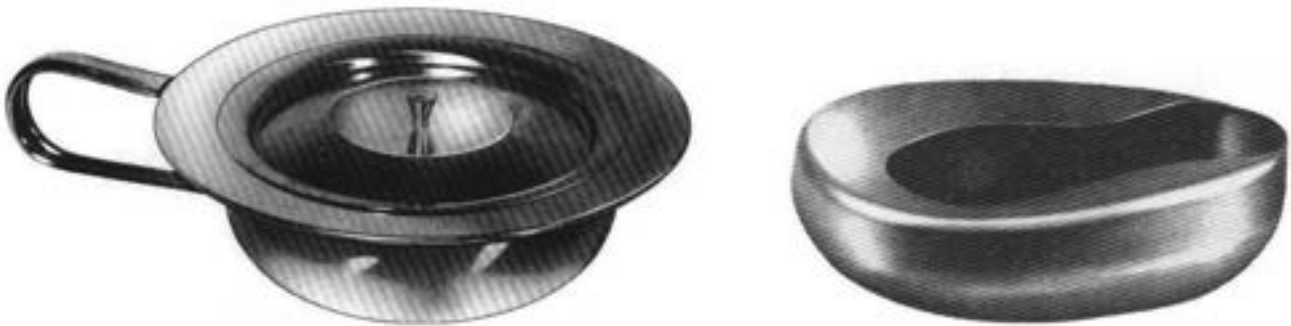
29-662-01
Ø 75 x 80 mm



29-662-02
Ø 75 x 80 mm



bowl only	lid only	sizes in mm (l x h)
29-670-15	29-672-15	150 x 65
29-670-20	29-672-20	200 x 90
29-670-23	29-672-23	235 x 105
29-670-25	29-672-25	250 x 115
29-670-28	29-672-28	280 x 120
29-670-30	29-672-30	300 x 140



lid with knob	Ø mm	sizes in mm (l x b)	
29-676-29	290	29-680-31	310 x 240
		29-680-35	350 x 290



29-686-30



29-688-30



29-694-36



Luniatschek
29-700-60
60 x 60 x 30 mm



29-706-10
Ø 50 x 100 mm



Methot
29-714-01
Ø 50 x 75 mm



Methot
29-714-02
Ø 50 x 75 mm



Methot
29-716-01
Ø 50 x 75 mm



29-730-10 100 cc
 29-730-12 120 cc
 29-730-15 150 cc
 29-730-20 200 cc



29-734-10 100 cc
 29-734-12 120 cc
 29-734-15 150 cc
 29-734-20 200 cc



29-738-10 100 cc
 29-738-12 120 cc
 29-738-15 150 cc
 29-738-20 200 cc



29-741-32 32 cm
29-741-50 50 cm



29-743-43
43 cm



29-770-18
 184 x Ø 3 mm



Partout
 29-772-19
 19 cm



Roghé
 29-775-19
 19 cm



Ratzow
 29-778-19
 19 cm

29-782-17
 80 mm

29-782-20
 100 mm



29-782-17 17.5 cm
 29-782-20 20.0 cm



29-784-19 19 cm 100 x 17 mm
 29-784-22 22 cm 130 x 20 mm
 29-784-25 25 cm 150 x 22 mm

malleable



1/2
 29-786-21
 21 cm
 105 x 30 mm

29-788-20
 rigid

29-790-19
 malleable



29-788-20 20 cm 100 x 23 mm
 29-790-19 19 cm 100 x 17 mm



1/2
Boley
29-794-10
0 - 100 mm



1/2
Iwanson
29-796-01



1/2
Iwanson
29-796-02



1/2
Iwanson
29-796-03



1/2
Iwanson
29-796-04

Waste Bucket



29-900-08 8 l
 29-900-10 10 l
 29-900-12 12 l
 29-900-15 15 l
 29-900-20 20 l

Lid



29-901-08
 29-901-10
 29-901-12
 29-901-15
 29-901-20

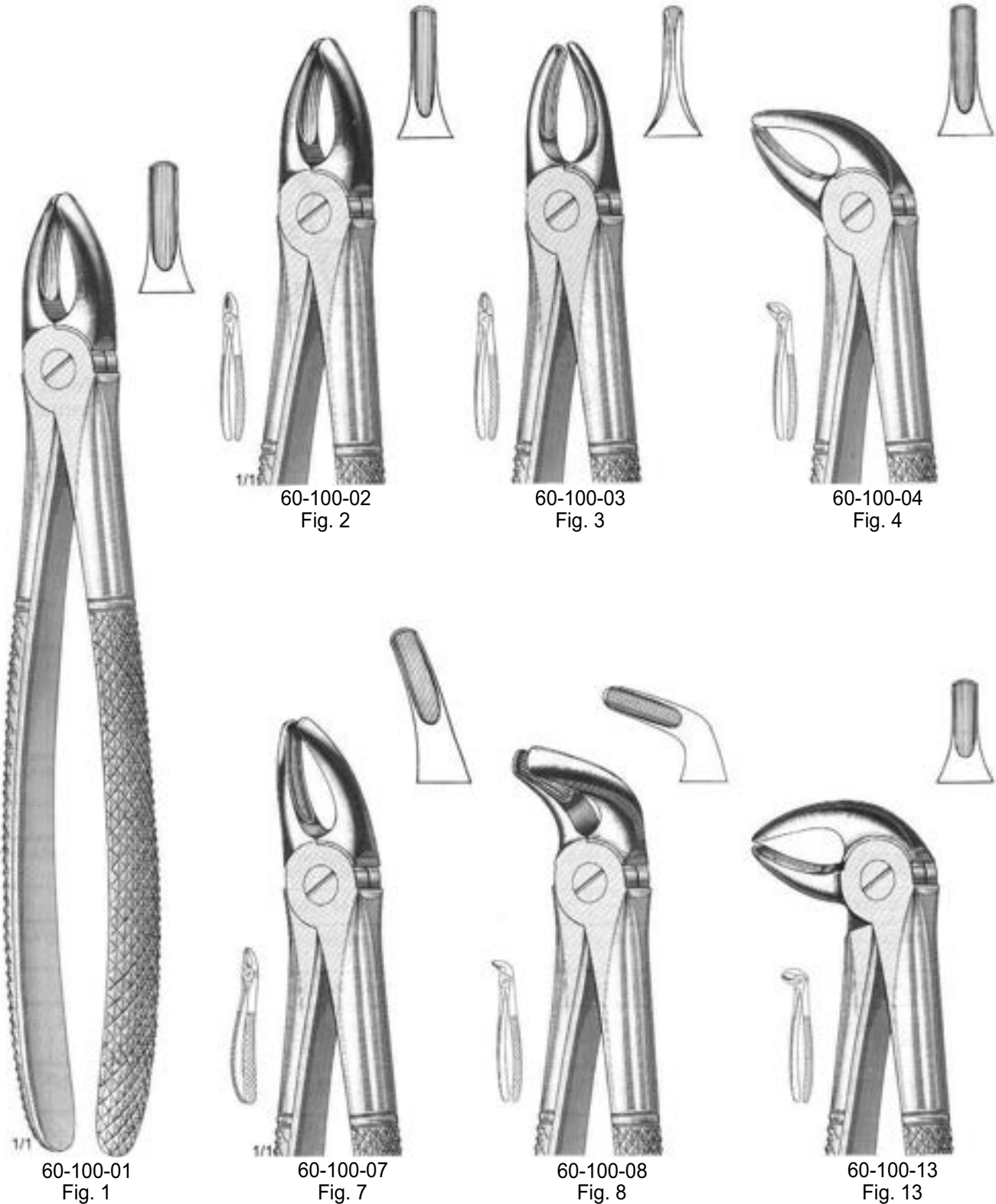


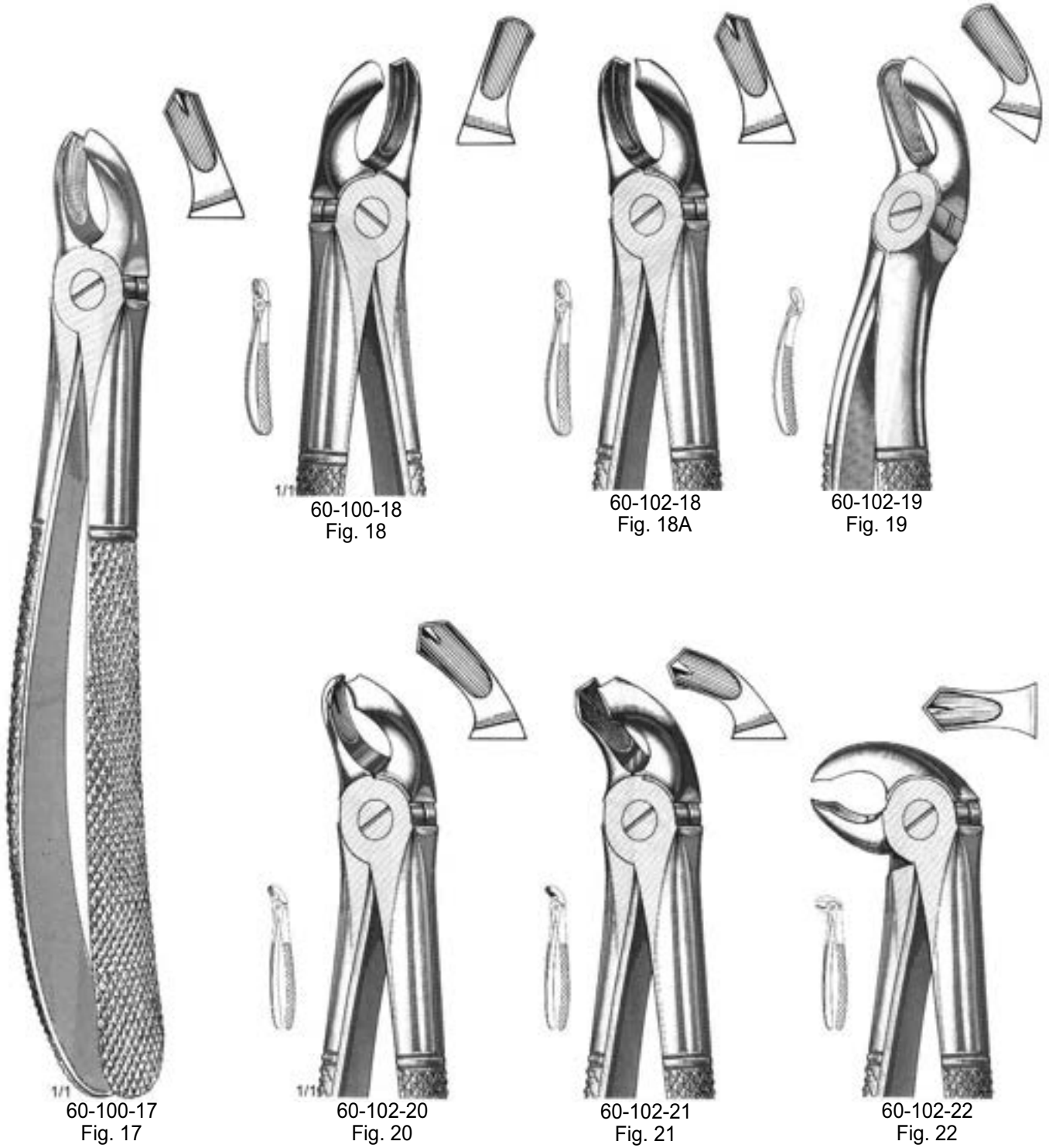
29-920-58
 58 cm



Sauerbruch
 29-924-58
 58 cm

60







60-102-23
Fig. 23



60-102-24
Fig. 24



60-102-29
Fig. 29



60-104-29
Fig. 29N



60-104-30
Fig. 30



60-104-31
Fig. 31



60-104-33
 Fig. 33



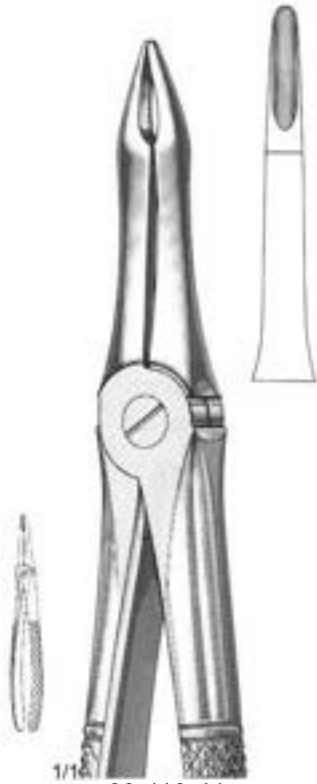
60-106-33
 Fig. 33A



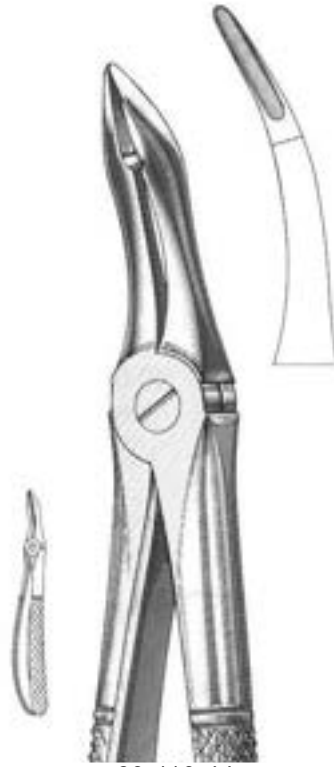
60-108-33
 Fig. 33C



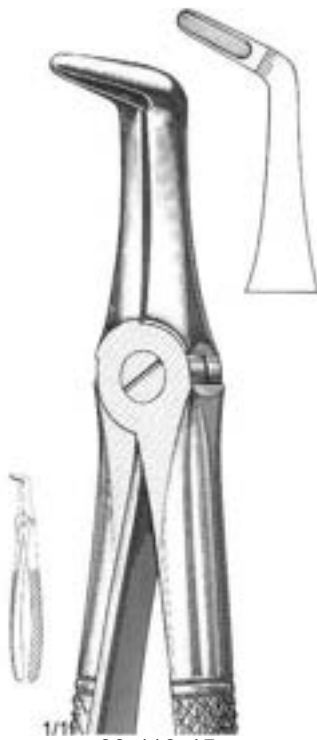
Mod. Martin
 60-110-33
 Fig. 33M



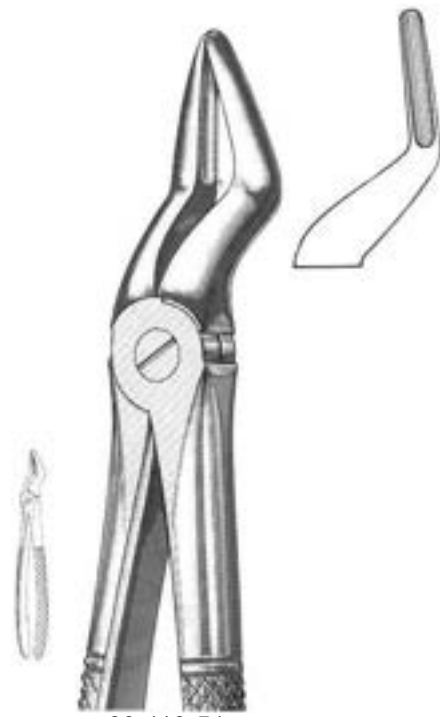
60-110-41
 Fig. 41



60-110-44
 Fig. 44



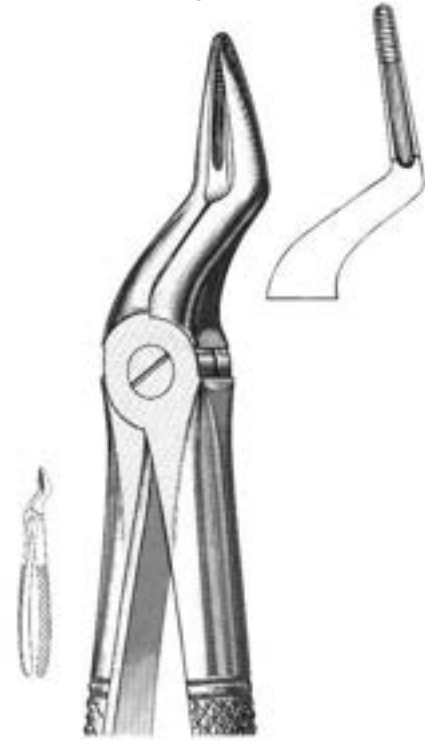
60-110-45
 Fig. 45



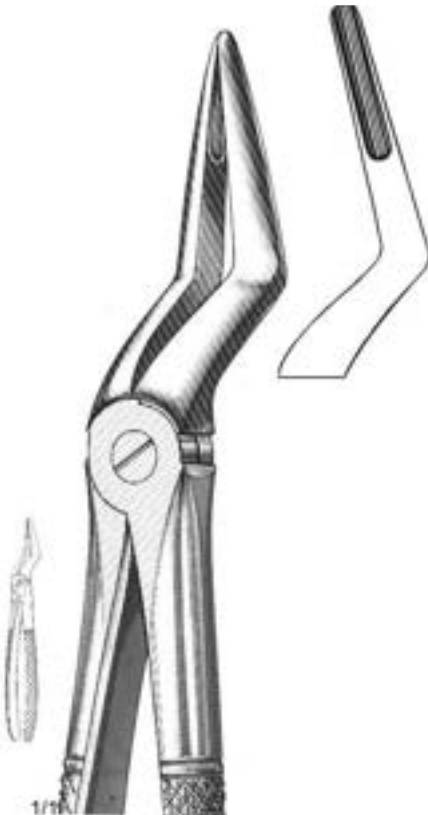
60-110-51
 Fig. 51



60-112-51
Fig. 51A



60-114-51
Fig. 51C



Mod. Martin
60-116-51
Fig. 51M



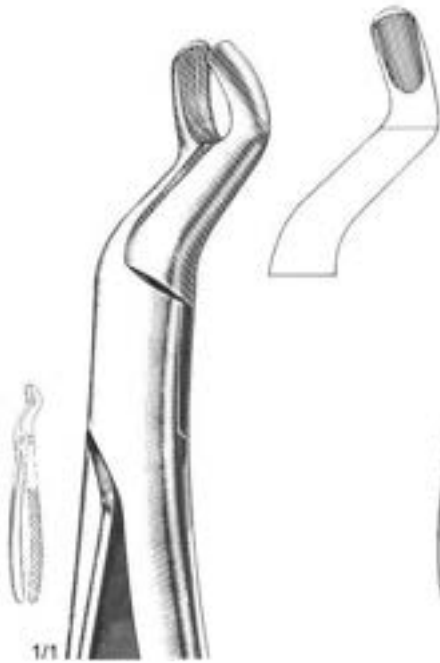
60-116-52
Fig. 52



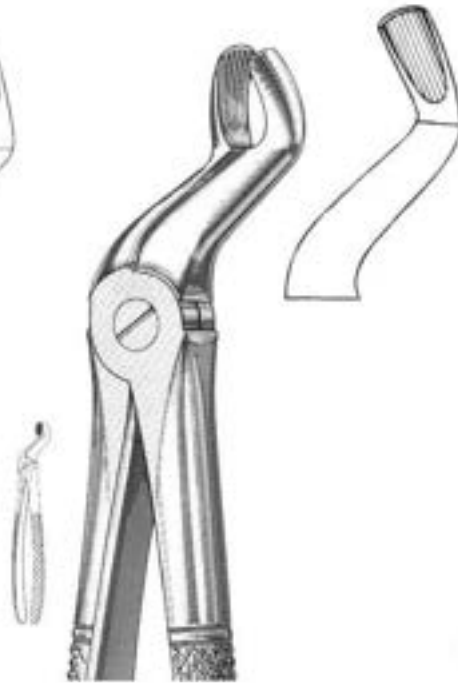
60-116-55
 Fig. 55



60-116-56
 Fig. 56



60-116-67
 Fig. 67



60-118-67
 Fig. 67A



60-118-73
 Fig. 73



60-118-74
Fig. 74



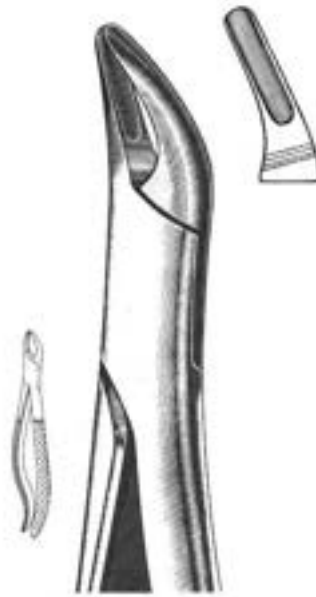
60-120-74
Fig. 74M



60-122-74
Fig. 74N



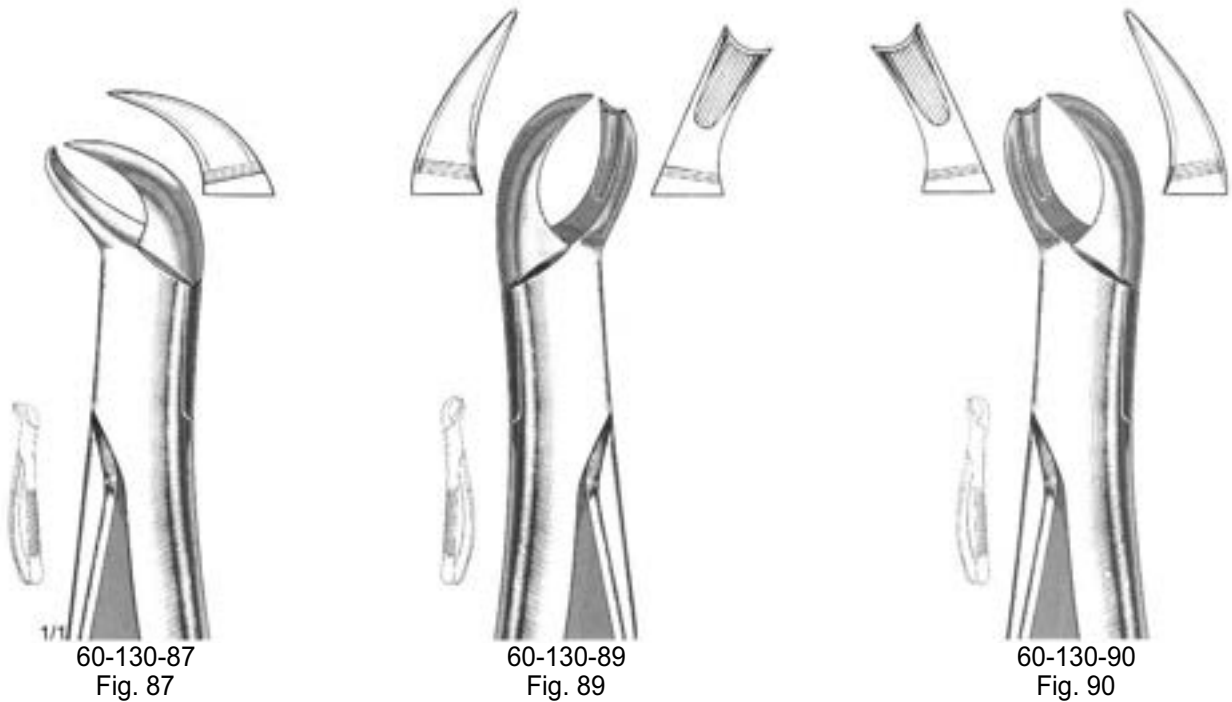
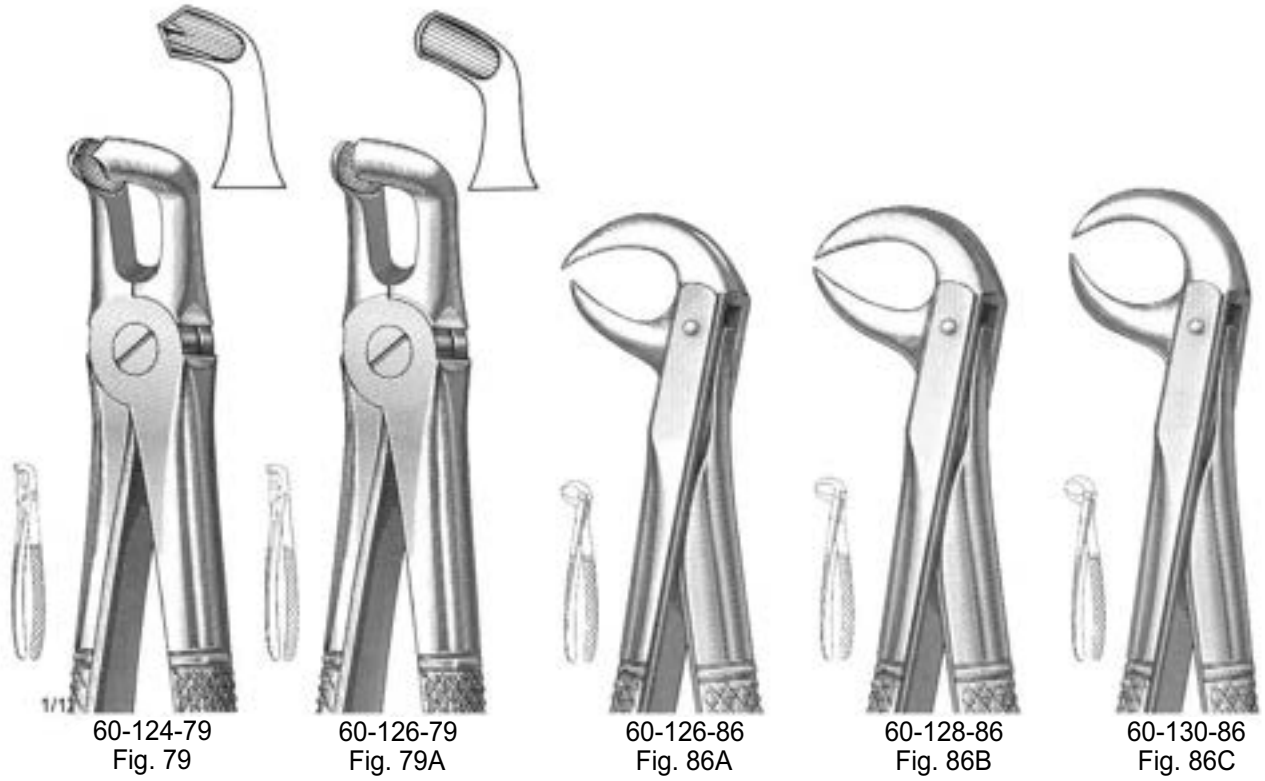
60-122-75
Fig. 75



Lawrence Read
60-122-76
Fig. 76



Lawrence Read
60-124-76
Fig. 76N





60-130-94
Fig. 94



60-130-95
Fig. 95



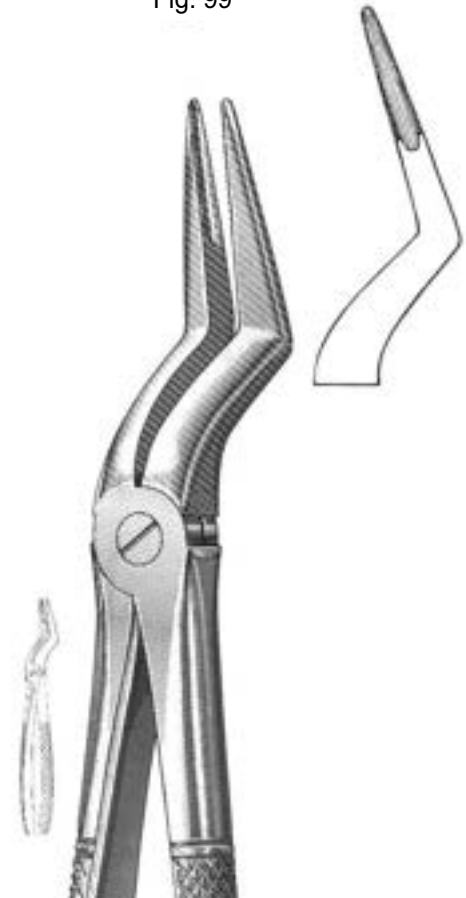
Wood (Passow)
60-130-99
Fig. 99



Odgen - Felsch
60-132-21
Fig. 121



60-132-33
Fig. 233



60-132-35
Fig. 235



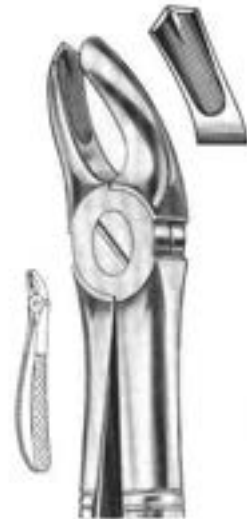
60-300-01
Fig. 1



60-300-02
Fig. 2



60-300-07
Fig. 7



60-300-17
Fig. 17



60-300-18
Fig. 18



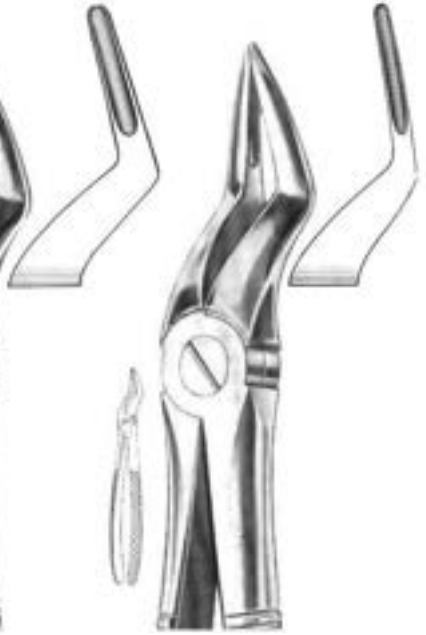
60-300-30
Fig. 30



60-300-39
Fig. 39



60-300-51
Fig. 51



60-302-51
Fig. 51A



60-302-67
Fig. 67A



60-302-73
Fig. 73



60-302-74
Fig. 74



60-304-74
Fig. 74N



60-304-79
Fig. 79



60-306-13
Fig. 13



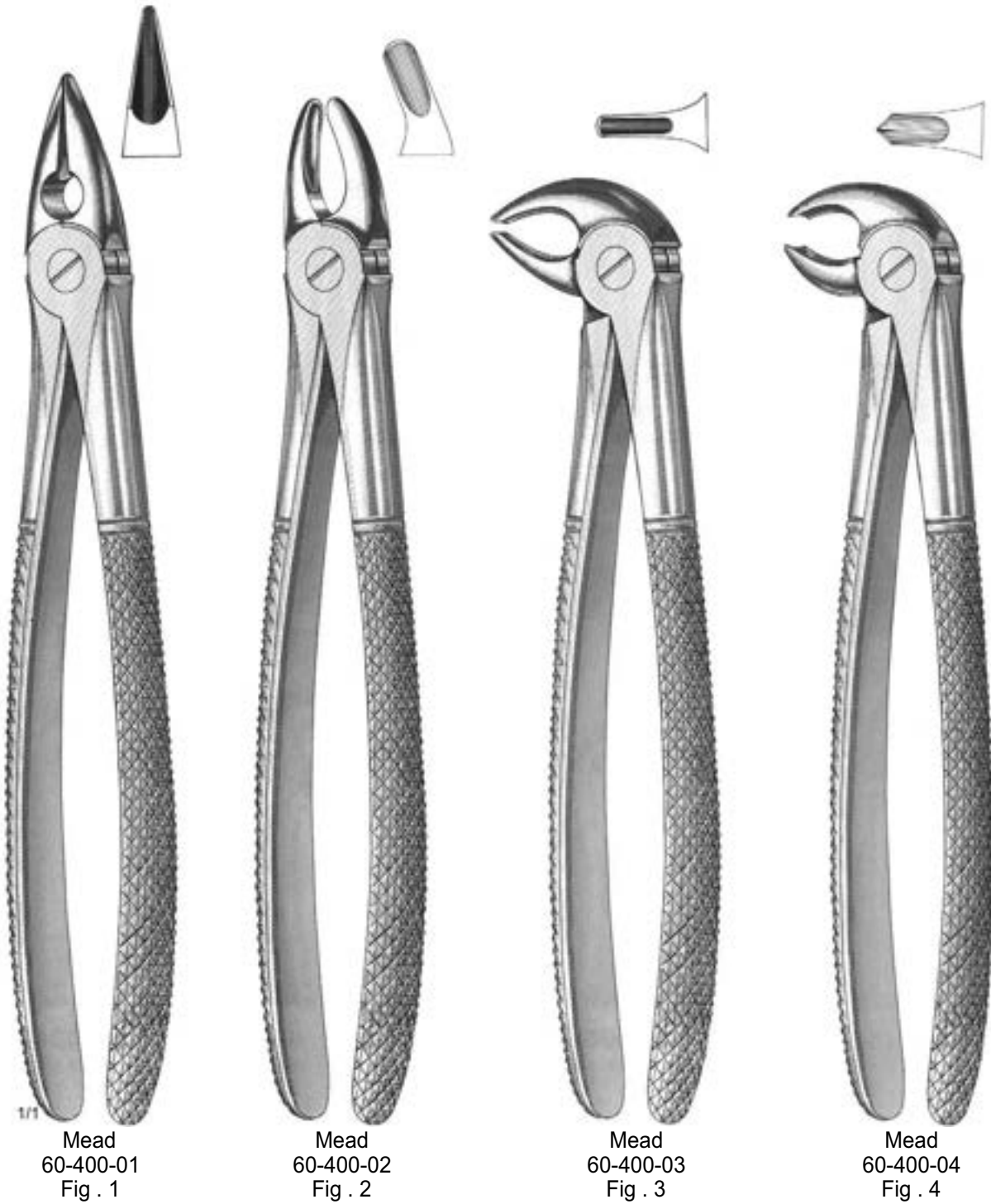
60-308-13
Fig. 13S

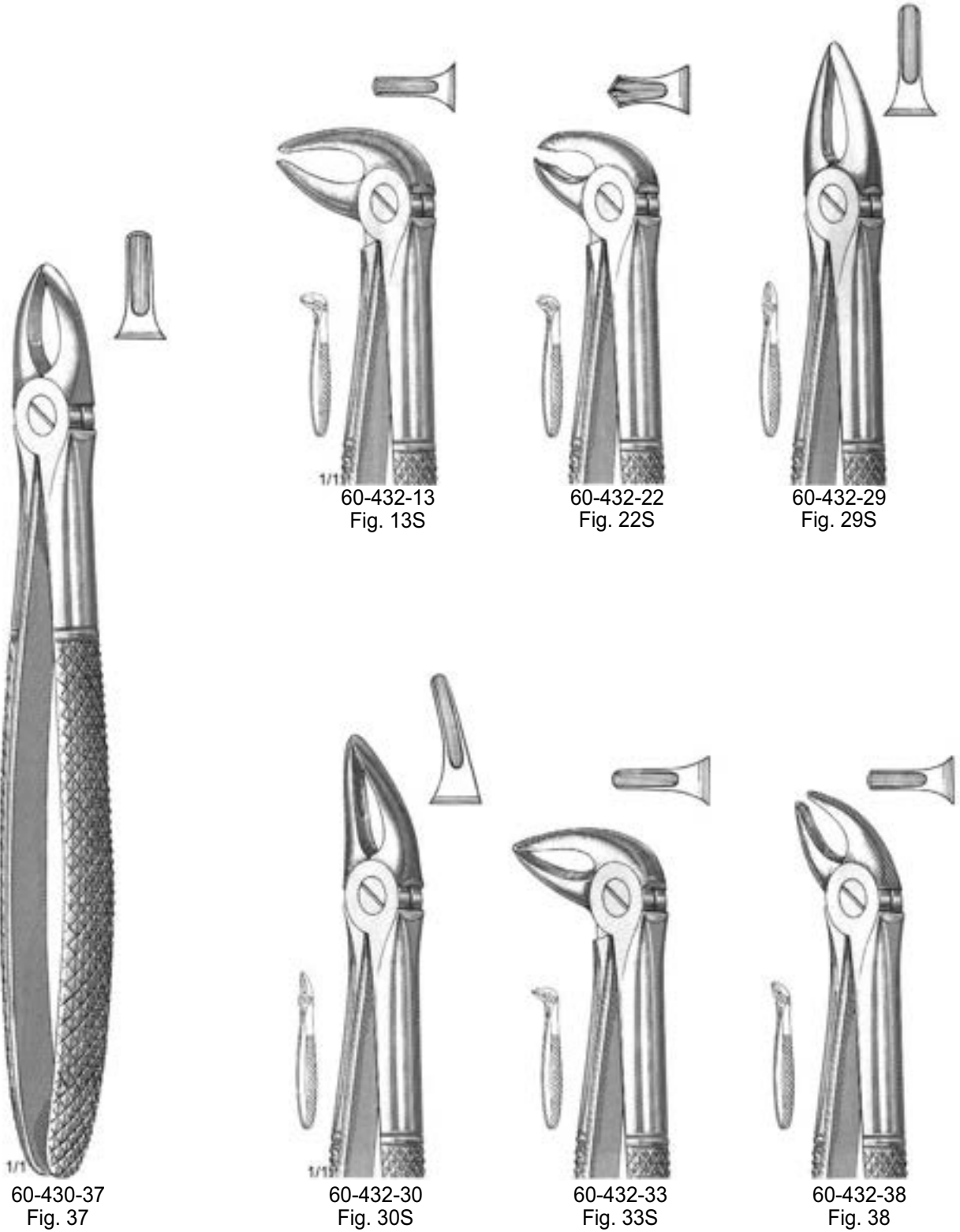


60-308-22
Fig. 22



60-308-33
Fig. 33



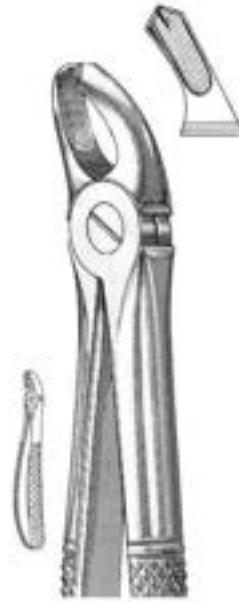




60-432-39
Fig. 39



60-434-39
Fig. 39A



60-436-39
Fig. 39L



60-438-39
Fig. 39R



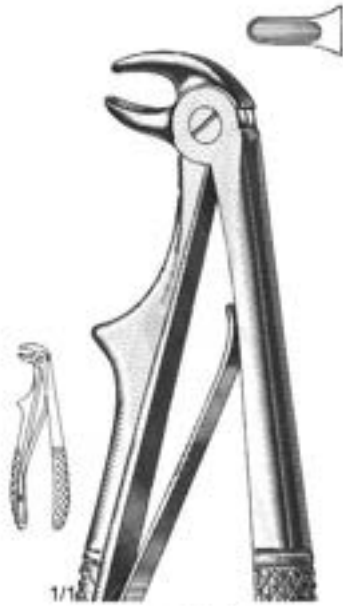
60-438-40
Fig. 40



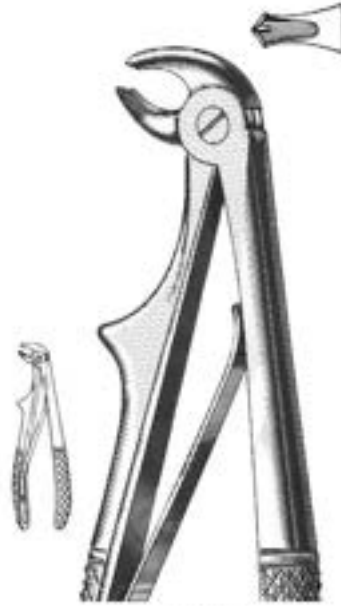
60-438-51
Fig. 51S



Lawrence Read
60-438-76
Fig. 76S



Klein
60-600-05
Fig. 5



Klein
60-600-06
Fig. 6



Klein
60-600-07
Fig. 7



Klein
60-600-03
Fig. 3



Klein
60-600-37
Fig. 137



Klein
60-600-39
Fig. 139



Klein
60-602-51
Fig. 51S





60-630-17
Fig. 17SK



60-630-23
Fig. 23SK



60-630-50
Fig. 150SK



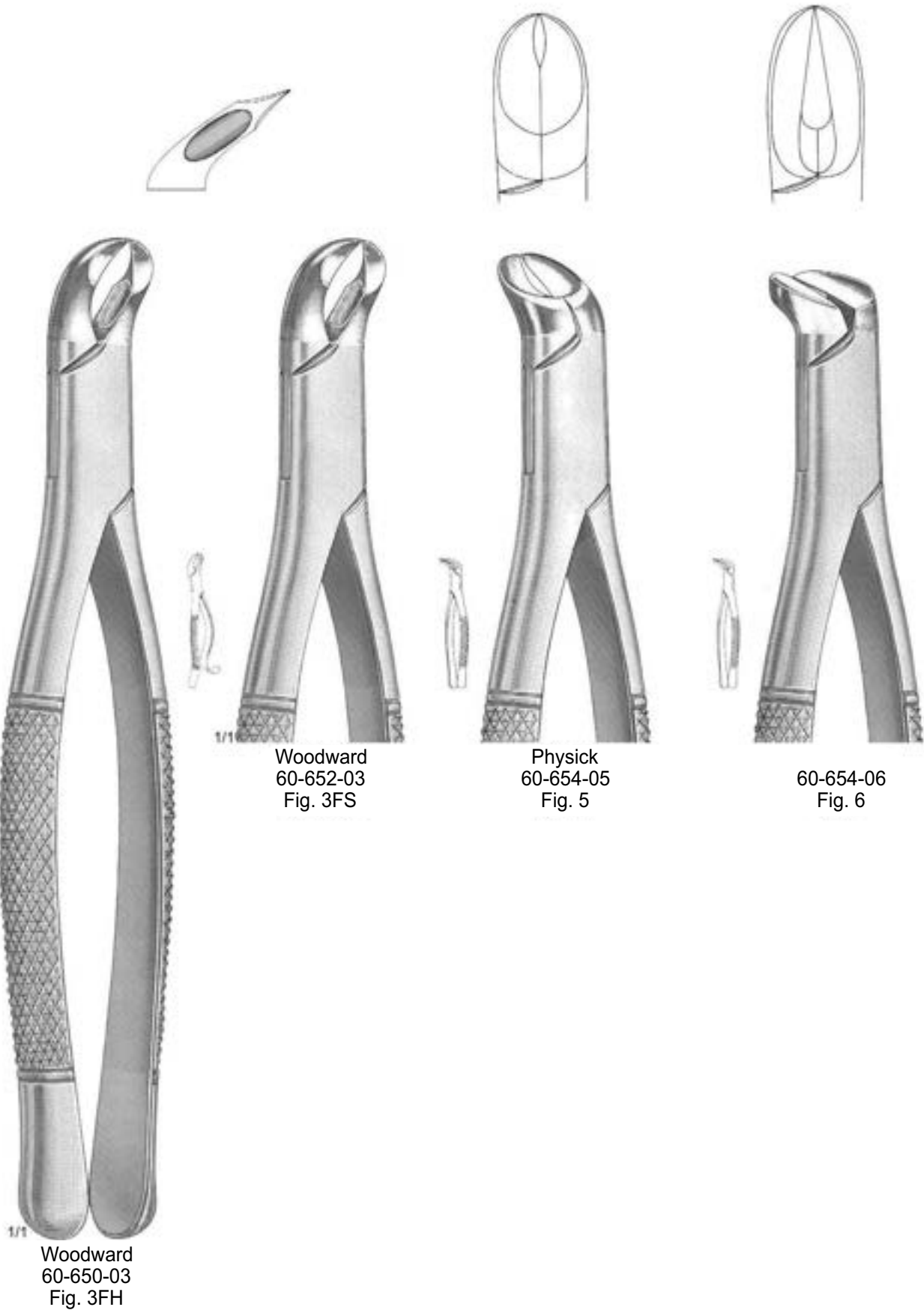
60-630-51
Fig. 151SK

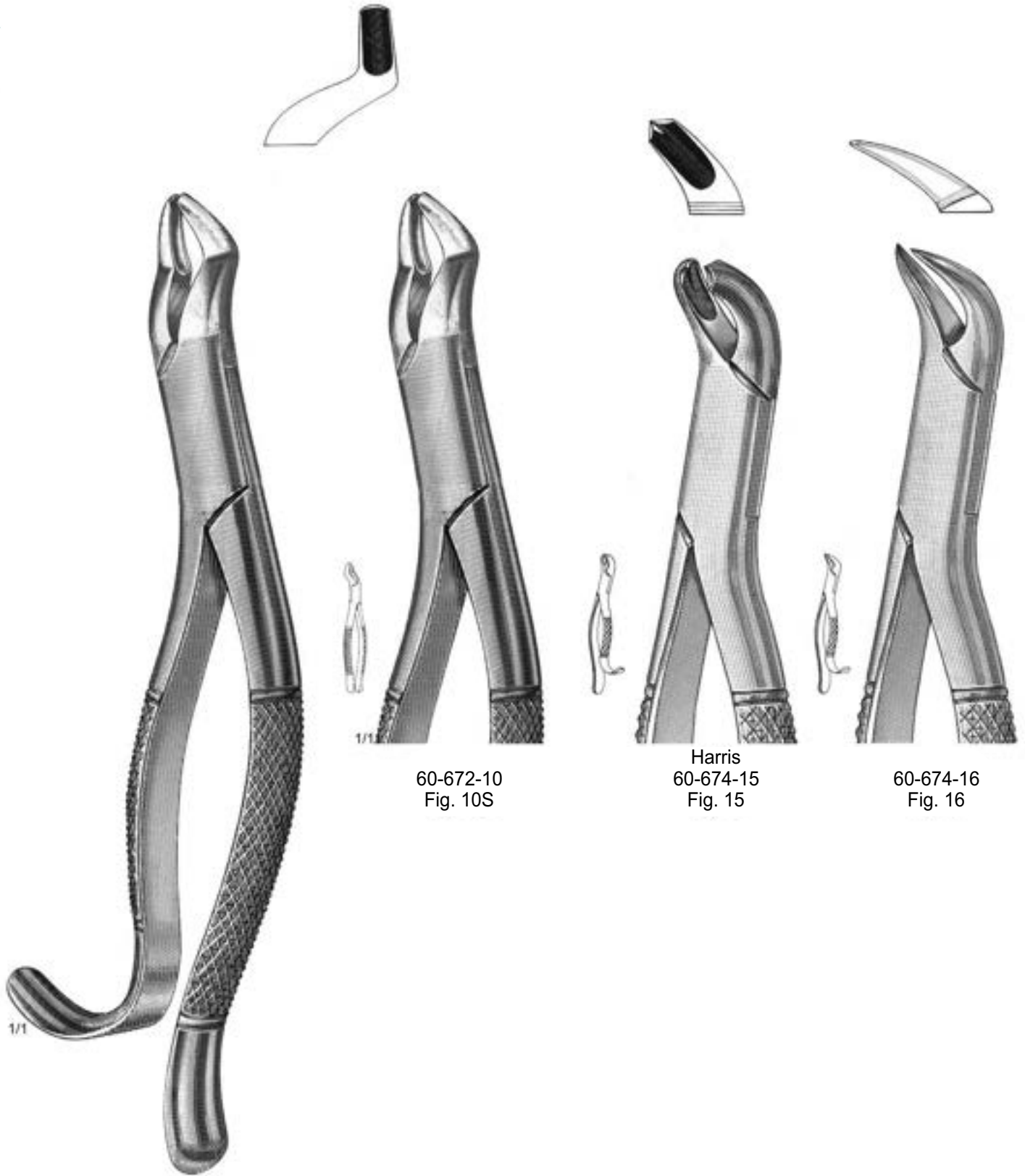


Standard
60-640-01
Fig. 1



Henan
60-642-01
Fig. 1A



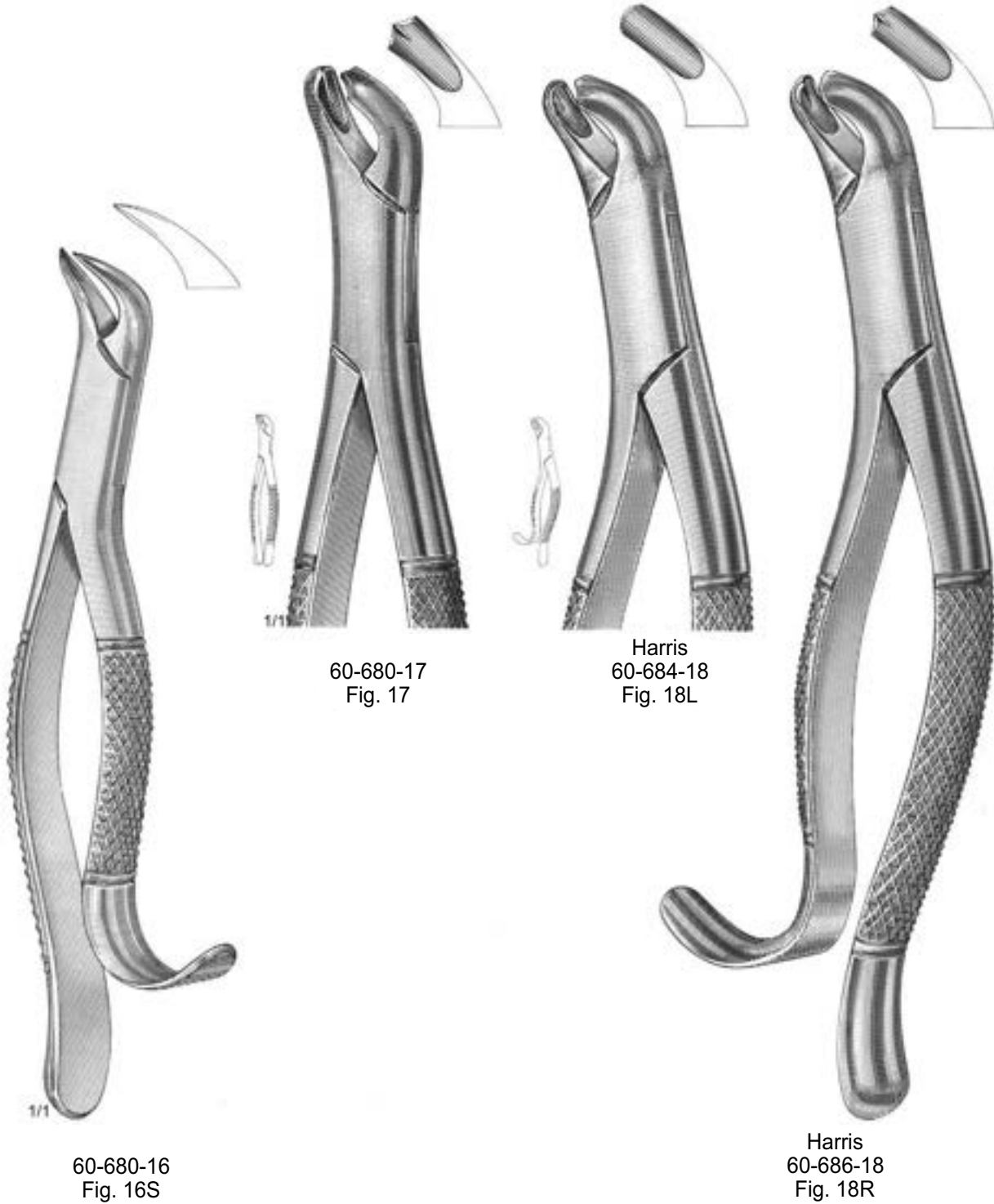


60-672-10
 Fig. 10S

Harris
 60-674-15
 Fig. 15

60-674-16
 Fig. 16

60-670-10
 Fig. 10H





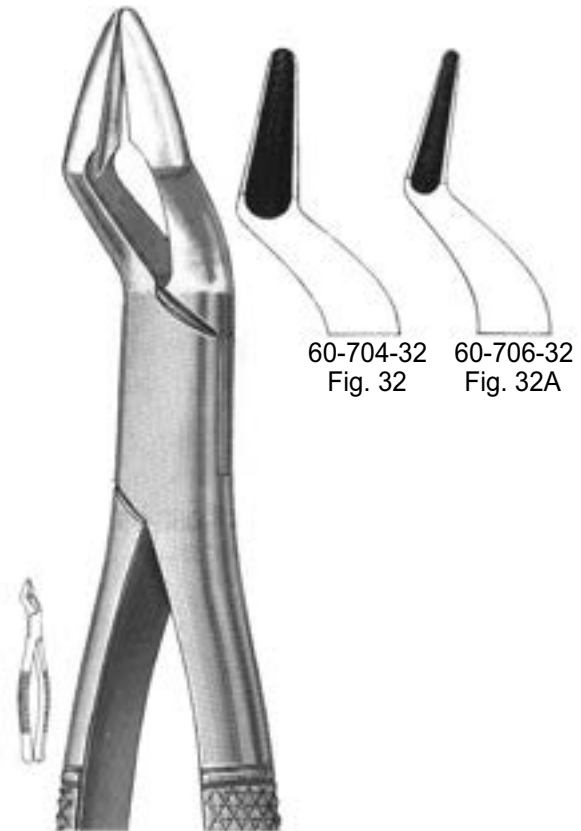
60-700-23
 Fig. 23



60-700-24
 Fig. 24



60-700-27
 Fig. 27



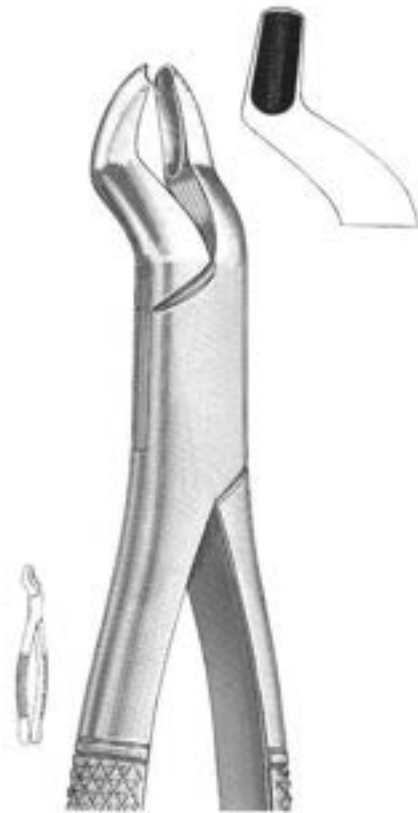
Parmly
 60-704-32 - 60-706-32

60-704-32
 Fig. 32

60-706-32
 Fig. 32A



60-710-53
Fig. 53L



60-712-53
Fig. 53R



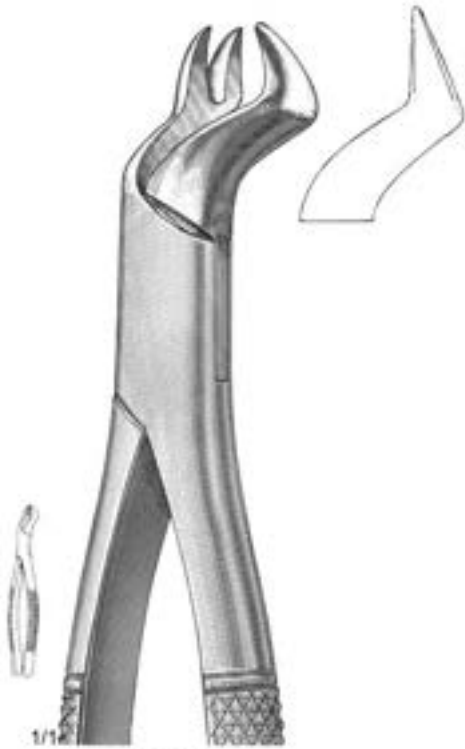
60-724-62
 Fig. 62



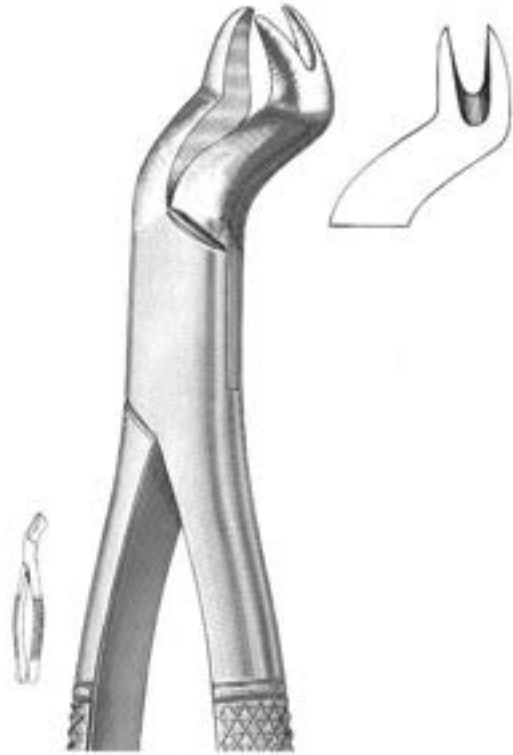
60-724-65
 Fig. 65



Tomes
 60-724-69
 Fig. 69



Nevius
60-740-88
Fig. 88L



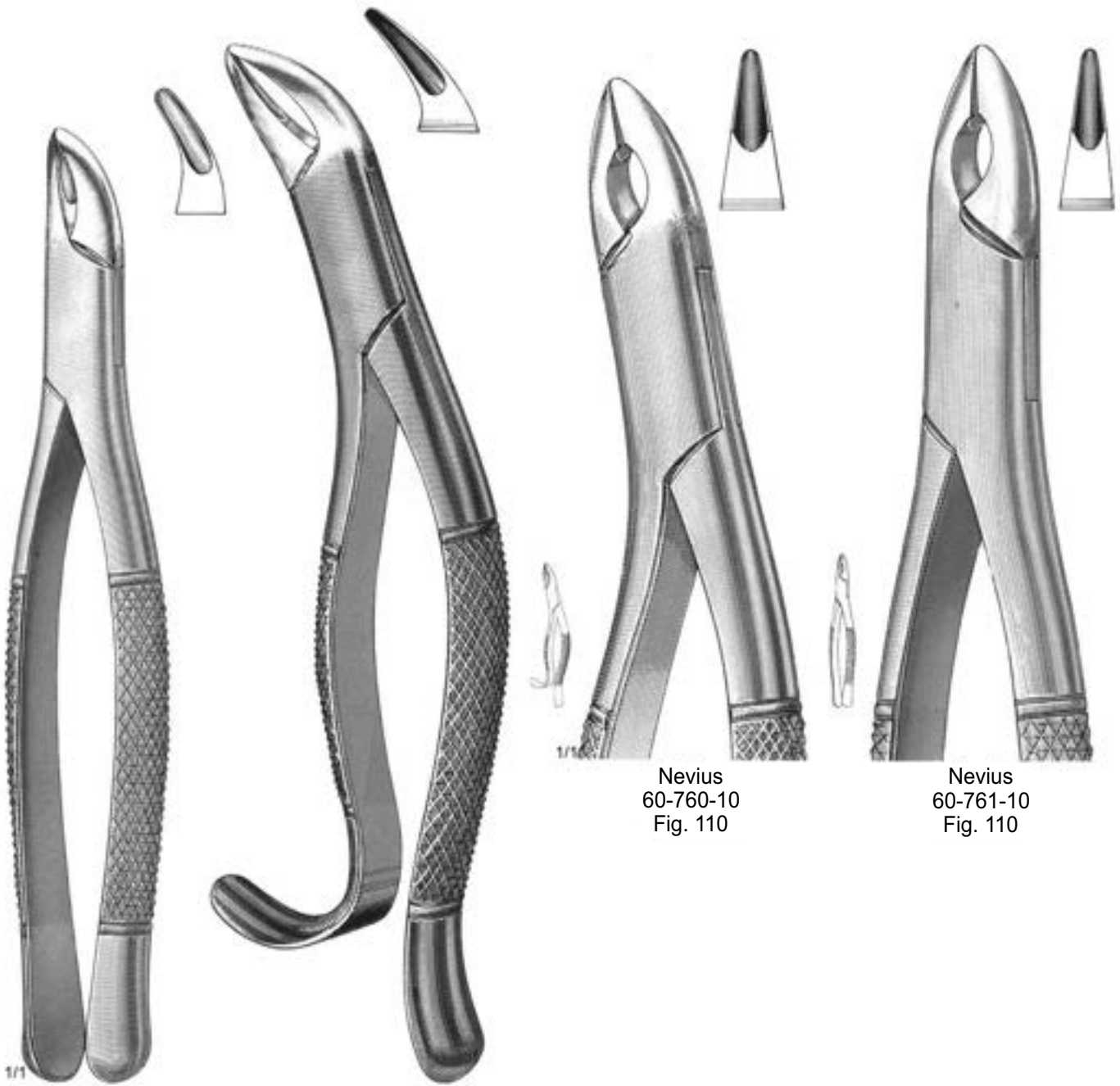
Nevius
60-742-88
Fig. 88R



Kells
60-754-99
Fig. 99A



Kells
60-756-99
Fig. 99C



Hull
 60-760-01
 Fig. 101

60-760-03
 Fig. 103

Nevius
 60-760-10
 Fig. 110

Nevius
 60-761-10
 Fig. 110



Cryer
 60-762-50
 Fig. 150



Cryer
 60-764-50
 Fig. 150A



Cryer
 60-766-50
 Fig. 150S



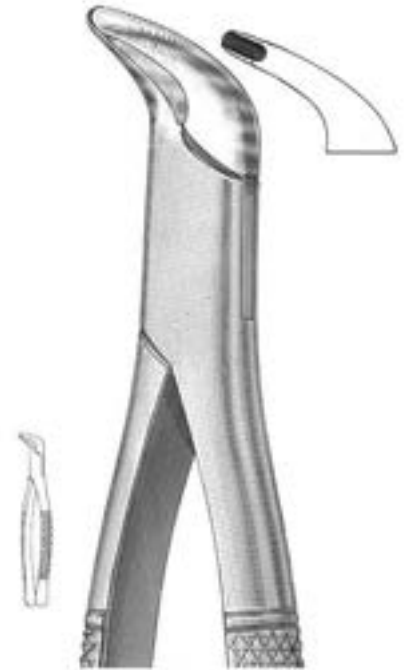
Cryer
 60-766-51
 Fig. 151



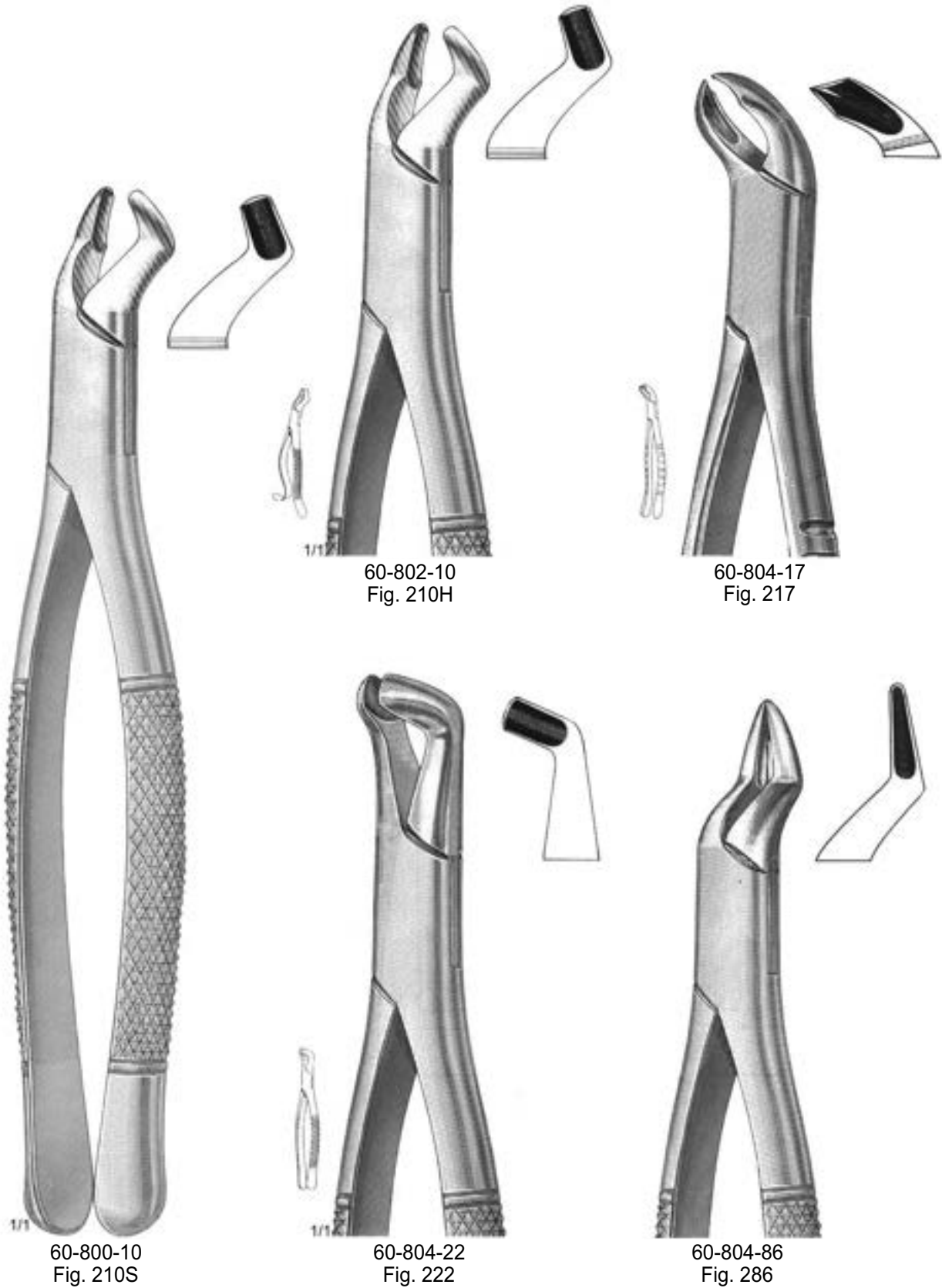
Cryer
60-768-51
Fig. 151A



Cryer
60-770-51
Fig. 151S



Cryer
60-772-03
Fig. 203





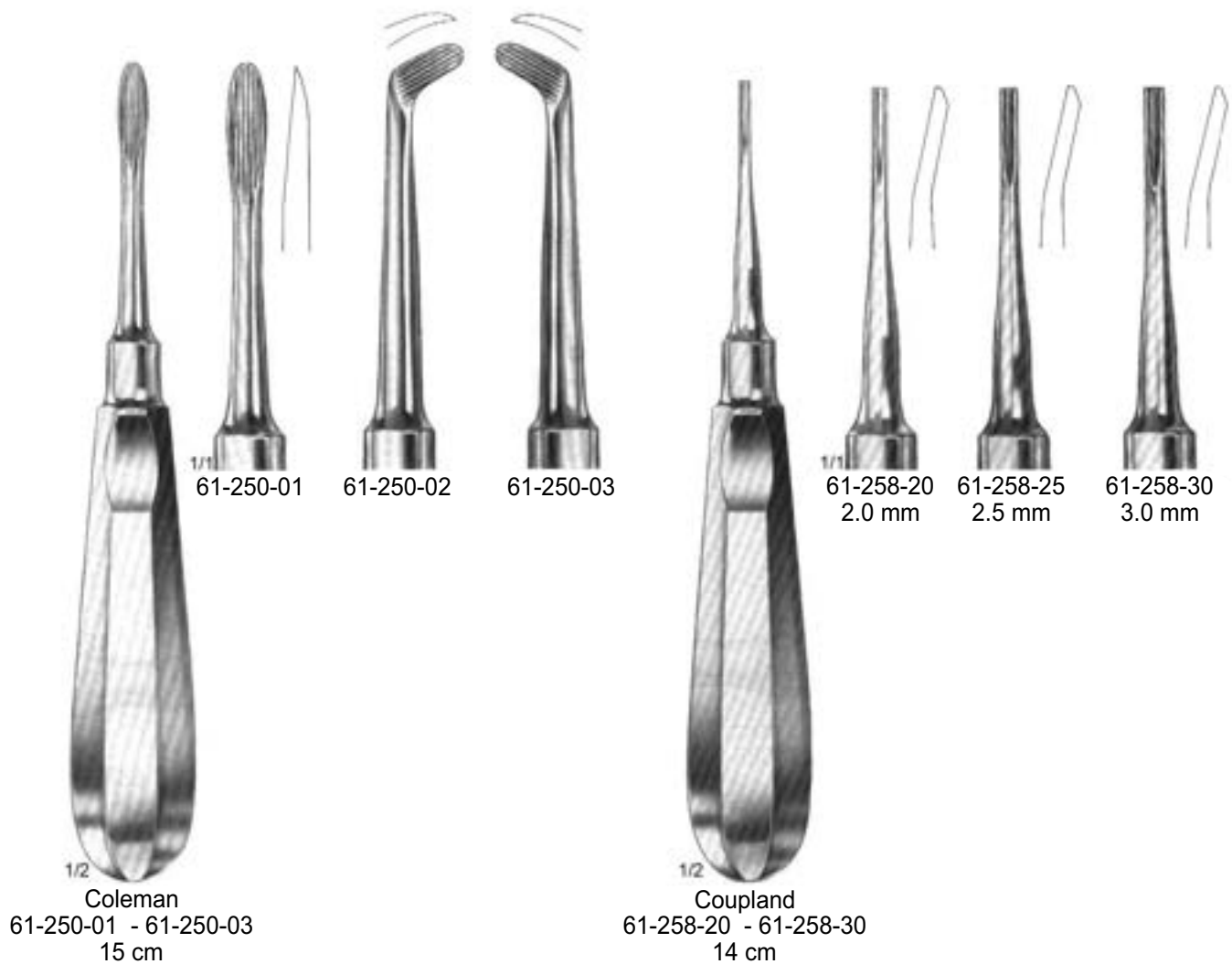
Witzel
60-840-01
Fig. 501

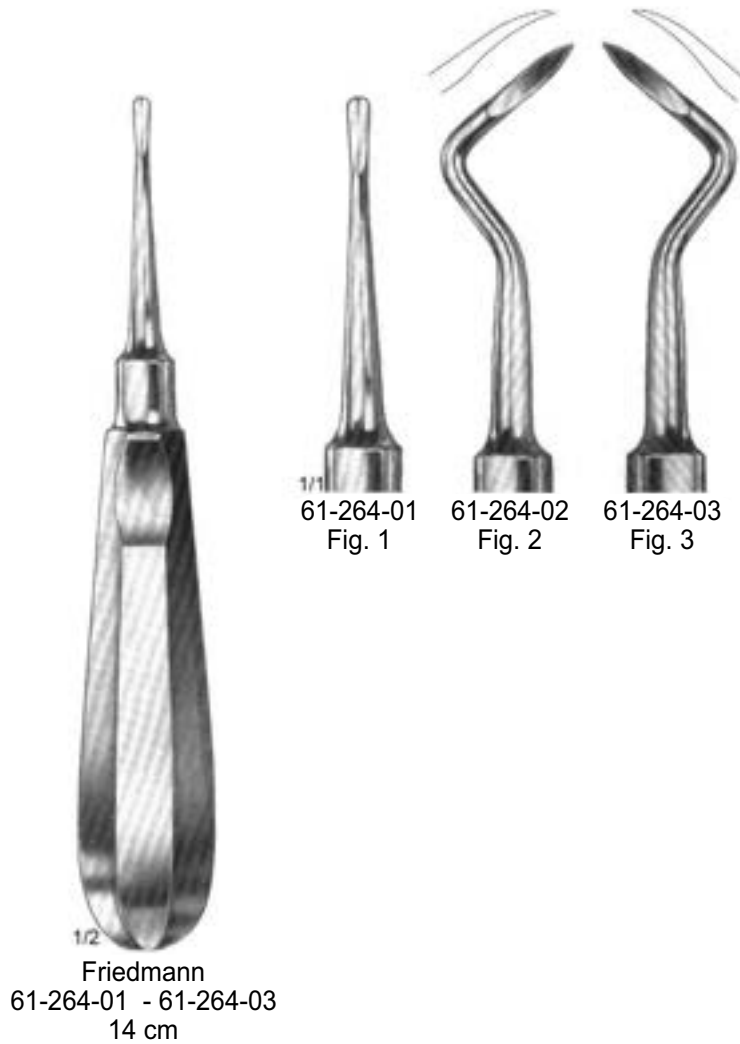


Witzel
60-840-02
Fig. 502

61









Hyllin
61-280-01 - 61-284-02



Bein
61-290-03 - 61-298-04





Walter F. Barry
 61-400-01 - 61-404-02



61-400-01
 Fig. 320



61-400-02
 Fig. 321



61-402-01
 Fig. 322



61-402-02
 Fig. 323



61-404-01
 Fig. 370



61-404-02
 Fig. 371



61-412-01
 Fig. 11L



61-412-02
 Fig. 11R



61-414-01
 Fig. 11L



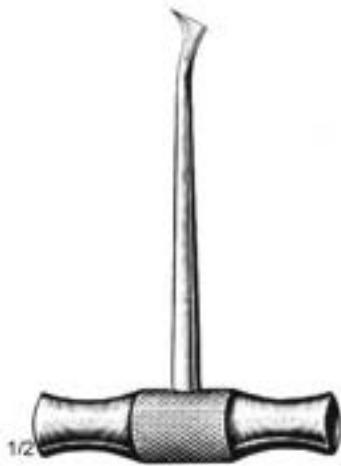
61-414-02
 Fig. 11R



61-416-01
 Fig. 12L



61-416-02
 Fig. 12R



Winter
 61-412-01 - 61-420-02



61-418-01
 Fig. 13L



61-418-02
 Fig. 13R



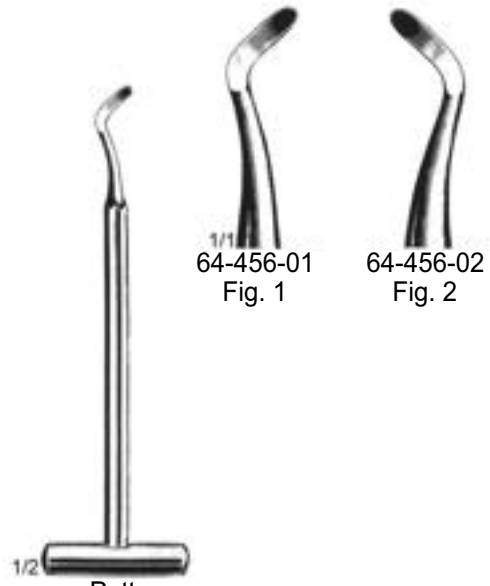
61-420-01
 Fig. 14L



61-420-02
 Fig. 14R



Lecluse
61-450-01



Pott
61-456-01 - 61-456-02



Krallenheber
61-468-01
Fig. 1



Krallenheber
61-468-02
Fig. 2



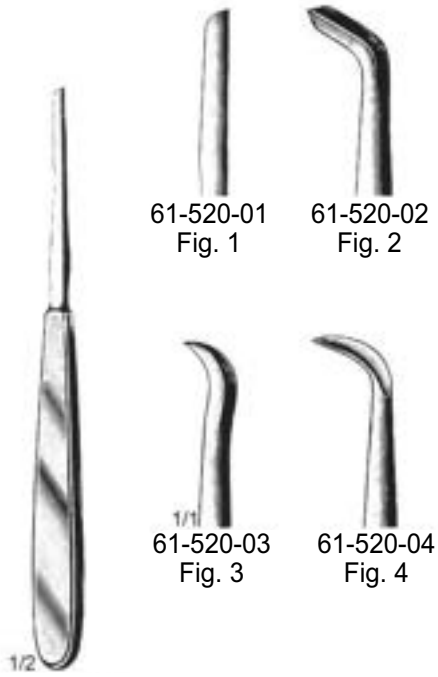
Warwick - James
61-488-01
Fig. 1



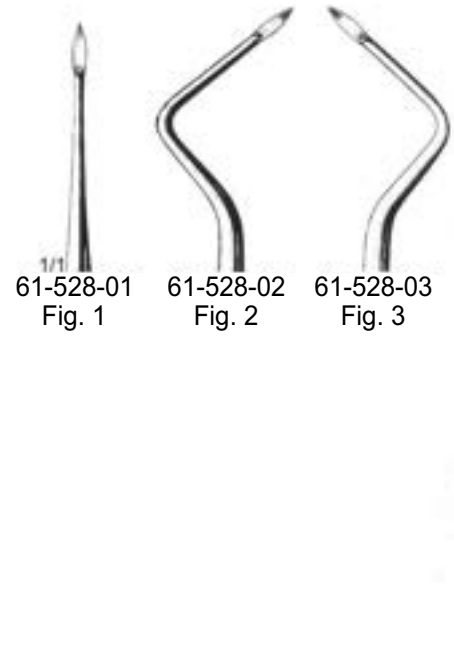
Warwick - James
61-488-02
Fig. 2



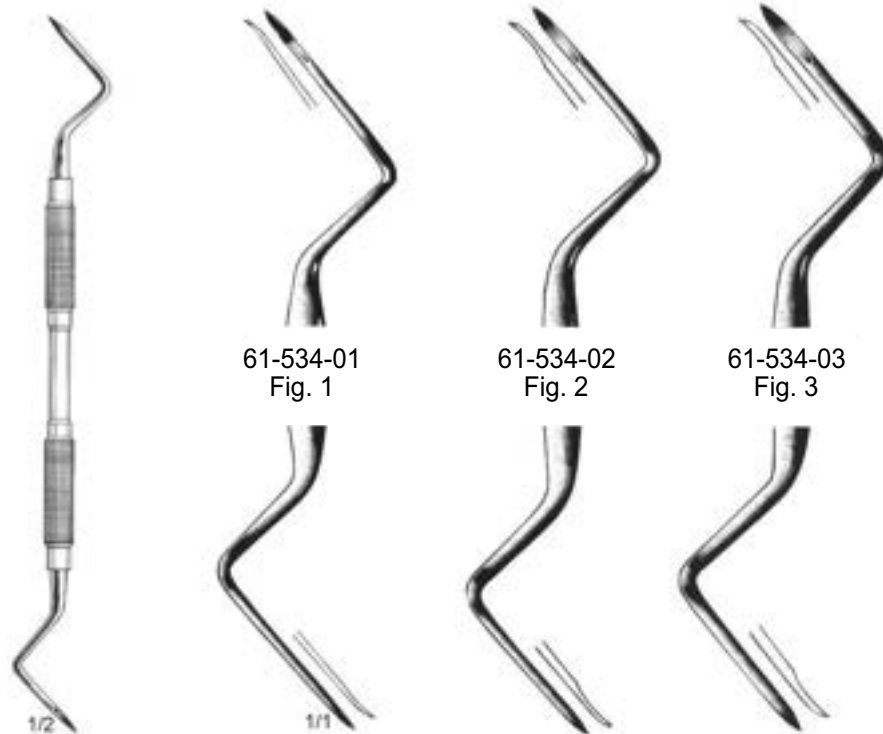
Warwick - James
61-488-03
Fig. 3



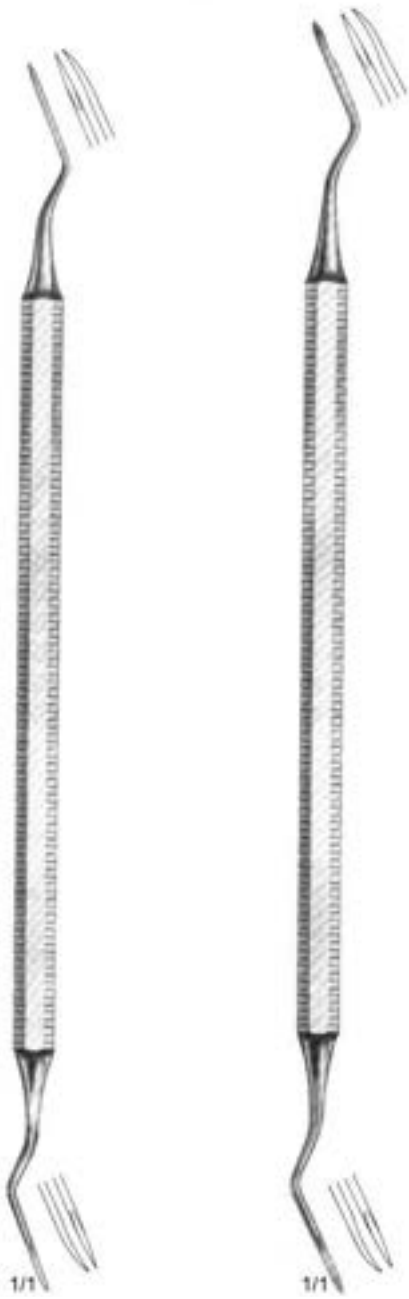
Chompret
61-520-01 - 61-520-04



Heidebrink
61-528-01 - 61-528-03



Heidebrink
61-534-01 - 61-534-02

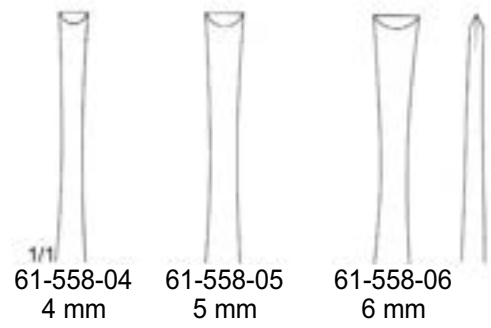


1/1
 West
 61-552-23
 Fig. 2/3

1/1
 West
 61-552-56
 Fig. 5/6



1/1
 Walter F. Barry
 61-558-04 - 61-558-06
 21.5 cm



1/1
 61-558-04
 4 mm

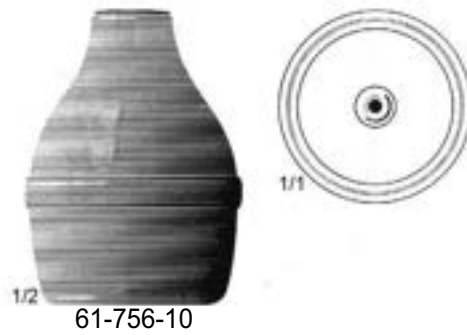
61-558-05
 5 mm

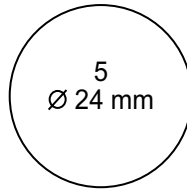
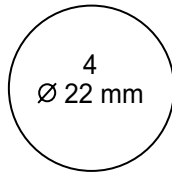
61-558-06
 6 mm



61-734-01	Ø 0.90 X 38 mm	Fig. 1
61-734-02	Ø 0.80 X 32 mm	Fig. 2
61-734-12	Ø 0.70 X 32 mm	Fig. 12
61-734-14	Ø 0.65 X 28 mm	Fig. 14
61-734-16	Ø 0.60 X 25 mm	Fig. 16
61-734-18	Ø 0.50 X 23 mm	Fig. 18
61-734-20	Ø 0.45 X 20 mm	Fig. 20

- 61-700-01 Cylinder cartridge syringe, 1.8 cc with adaptors 61-702-02/-03, without aspiration with metric thread
- 61-700-02 Cylinder cartridge syringe, 2.2 cc with adaptors 61-702-02/-03, without aspiration with metric thread
- 61-700-03 Cylinder cartridge syringe, 1.8 cc with adaptors 61-702-02/-03, without aspiration with U.S. thread
- 61-700-04 Cylinder cartridge syringe, 2.2 cc with adaptors 61-702-02/-03, without aspiration with U.S. thread
- 61-706-01 Cylinder cartridge syringe, 1.8 cc with adaptors 61-702-02/-03, with aspiration device with metric thread
- 61-706-02 Cylinder cartridge syringe, 2.2 cc with adaptors 61-702-02/-03, with aspiration device with metric thread
- 61-706-03 Cylinder cartridge syringe, 1.8 cc with adaptors 61-702-02/-03, with aspiration device with U.S. thread
- 61-706-04 Cylinder cartridge syringe, 2.2 cc with adaptors 61-702-02/-03, with aspiration device with U.S. thread
- 61-712-01 Cylinder cartridge syringe, 1.8 cc with aspiration device with metric thread
- 61-712-02 Cylinder cartridge syringe, 2.2 cc with aspiration device with metric thread
- 61-712-03 Cylinder cartridge syringe, 1.8 cc with aspiration device with U.S. thread
- 61-712-04 Cylinder cartridge syringe, 2.2 cc with aspiration device with U.S. thread
- 61-718-01 Cartridge syringe, 1.8 cc with metric thread with 3 movable aspiration hooks for a safe aspiration
- 61-718-02 Cartridge syringe, 1.8 cc with U.S. thread with 3 movable aspiration hooks for a safe aspiration





plane, simple thread
 61-800-22 Fig. 4 Ø 4 mm
 61-800-24 Fig. 5 Ø 5 mm



magnifying, simple thread
 61-802-22 Fig. 4 Ø 4 mm
 61-802-24 Fig. 5 Ø 5 mm



plane, cone - socket
 61-810-22 Fig. 4 Ø 4 mm
 61-810-24 Fig. 5 Ø 5 mm



magnifying, cone - socket
 61-812-22 Fig. 4 Ø 4 mm
 61-812-24 Fig. 5 Ø 5 mm



1/1
Hilger
61-832-18
18 cm

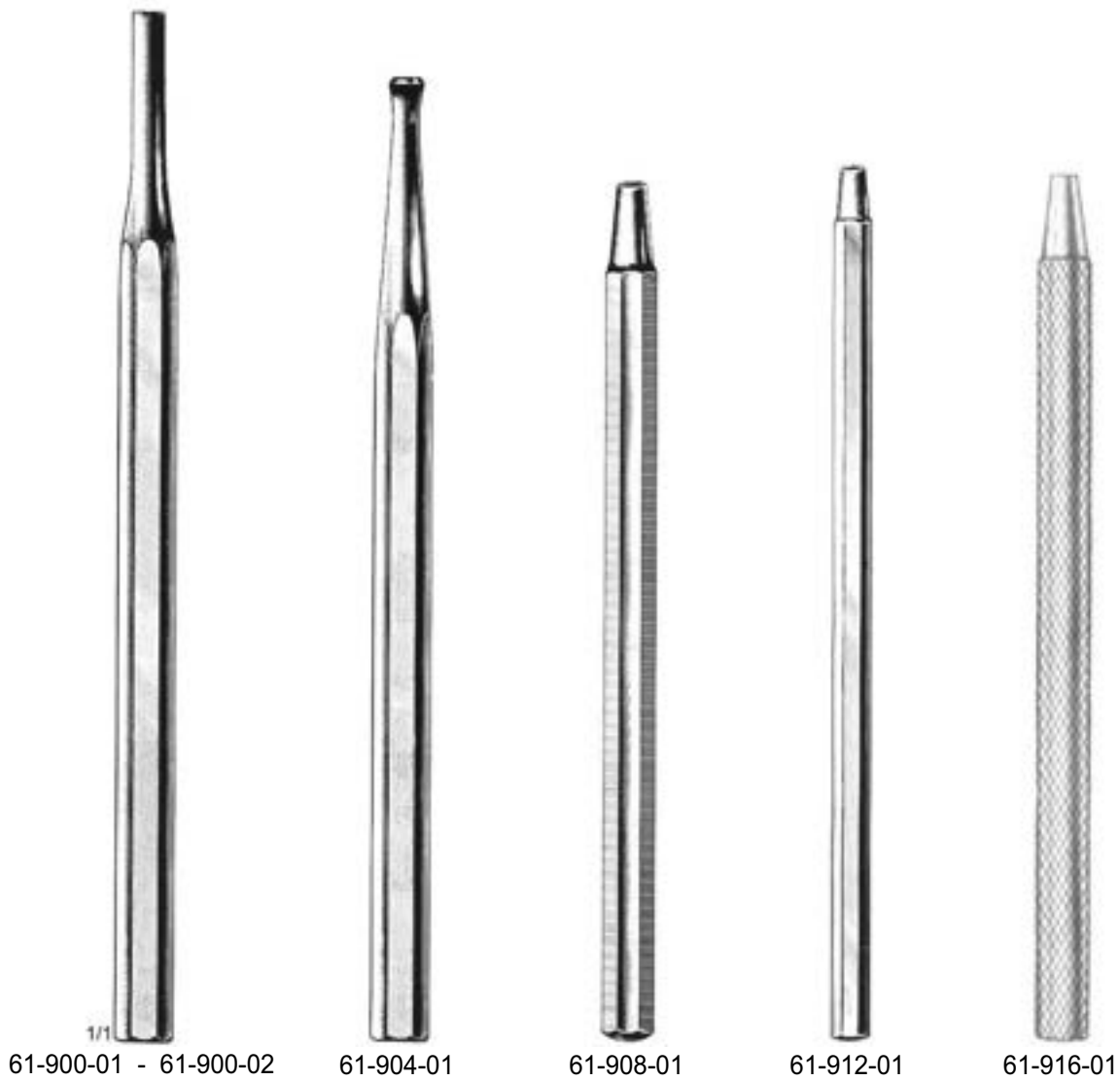


1/1
61-836-14
14 cm



1/1
Hilger
61-838-04
4.5 cm

61-900-01 plain
 61-900-02 cone - socket



62



62-101-01
Fig. 1



62-101-02
Fig. 2



62-101-03
Fig. 3



62-101-04
Fig. 4



62-101-05
62-105-05
Fig. 5



62-101-06
Fig. 6



62-101-08
62-105-08
Fig. 8



London College
62-101-01 - 62-101-06
15 cm



London College
62-105-05 - 62-105-08
15 cm



62-121-01
 62-125-01
 Fig. 1



62-121-02
 62-125-02
 Fig. 2



62-121-03
 62-125-03
 Fig. 3



62-121-04
 62-125-04
 Fig. 4



62-121-05
 Fig. 5



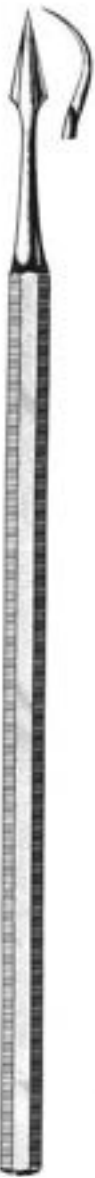
62-121-06
 Fig. 6



1/2
 Meriam
 62-121-01 - 62-121-06
 16 cm



Meriam
 62-125-01 - 62-125-04
 16 cm



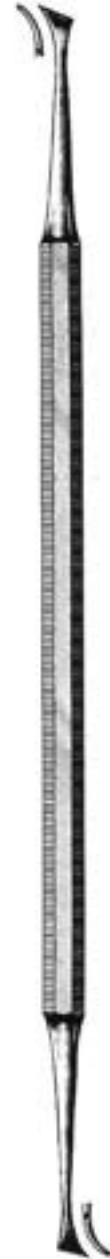
62-221-01 - 62-251-18



1/1
Cumine
62-301-02



Mitchell
62-305-02



62-309-34

anterior

posterior

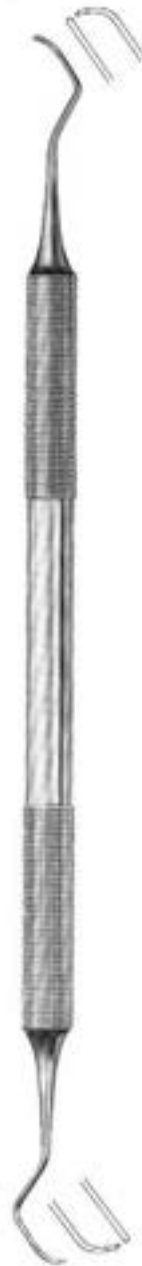
universal



Columbia
62-331-02
Fig. 2R/2L



Columbia
62-331-04
Fig. 4R/4L



Columbia
62-331-14
Fig. 13/14



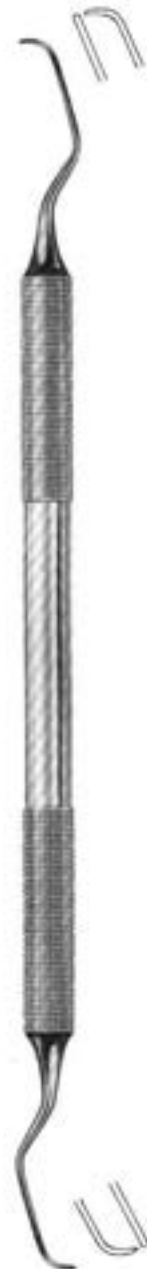
Younger - Good
62-335-08
Fig. 7/8



Langer
62-351-02
Fig. 1/2



Langer
62-351-04
Fig. 3/4



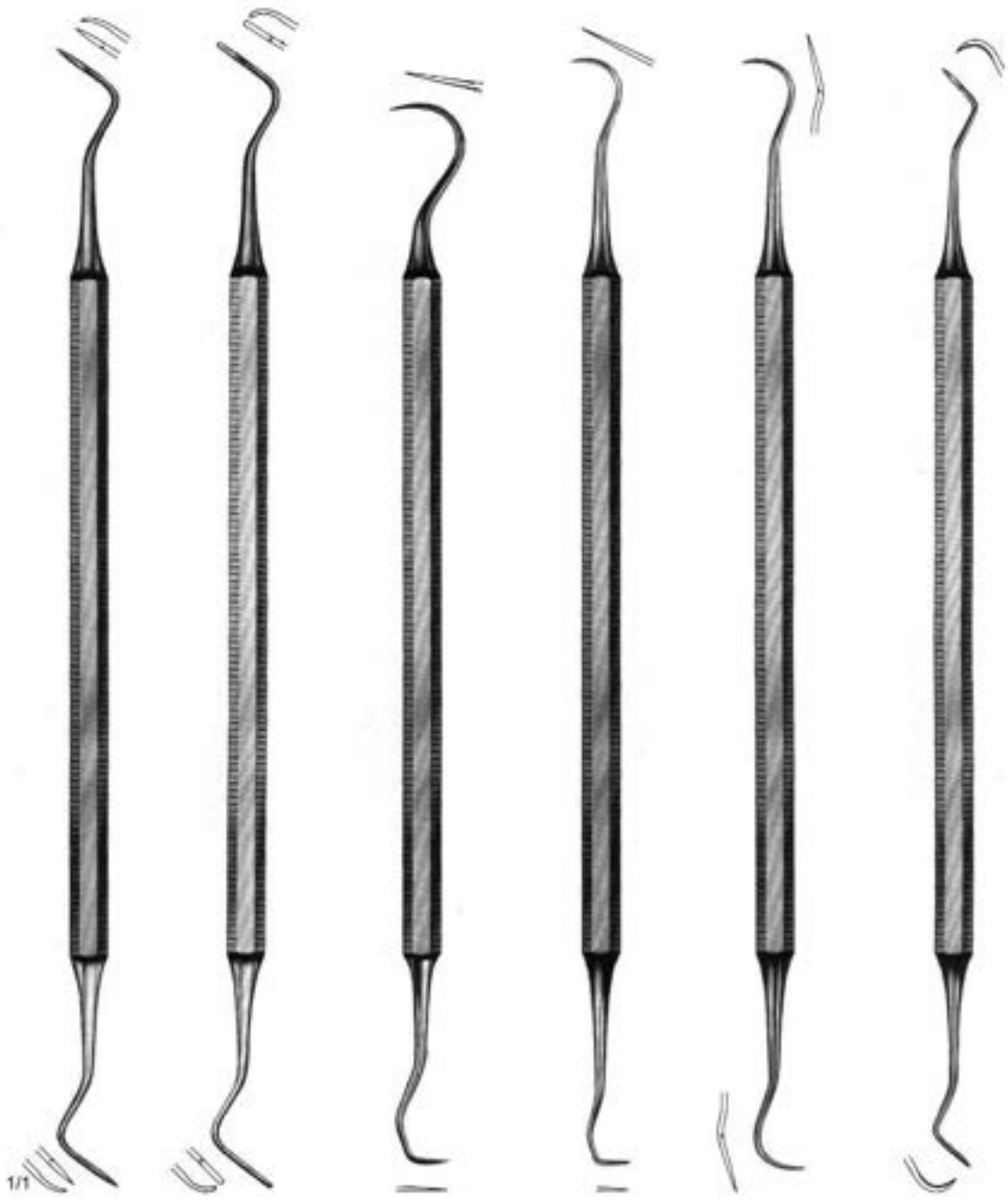
Langer
62-351-06
Fig. 5/6



Hirschfeld
62-421-07
Fig. 3/7



Hirschfeld
62-421-11
Fig. 5/11



McCall
62-471-01
Fig. 13S/14S

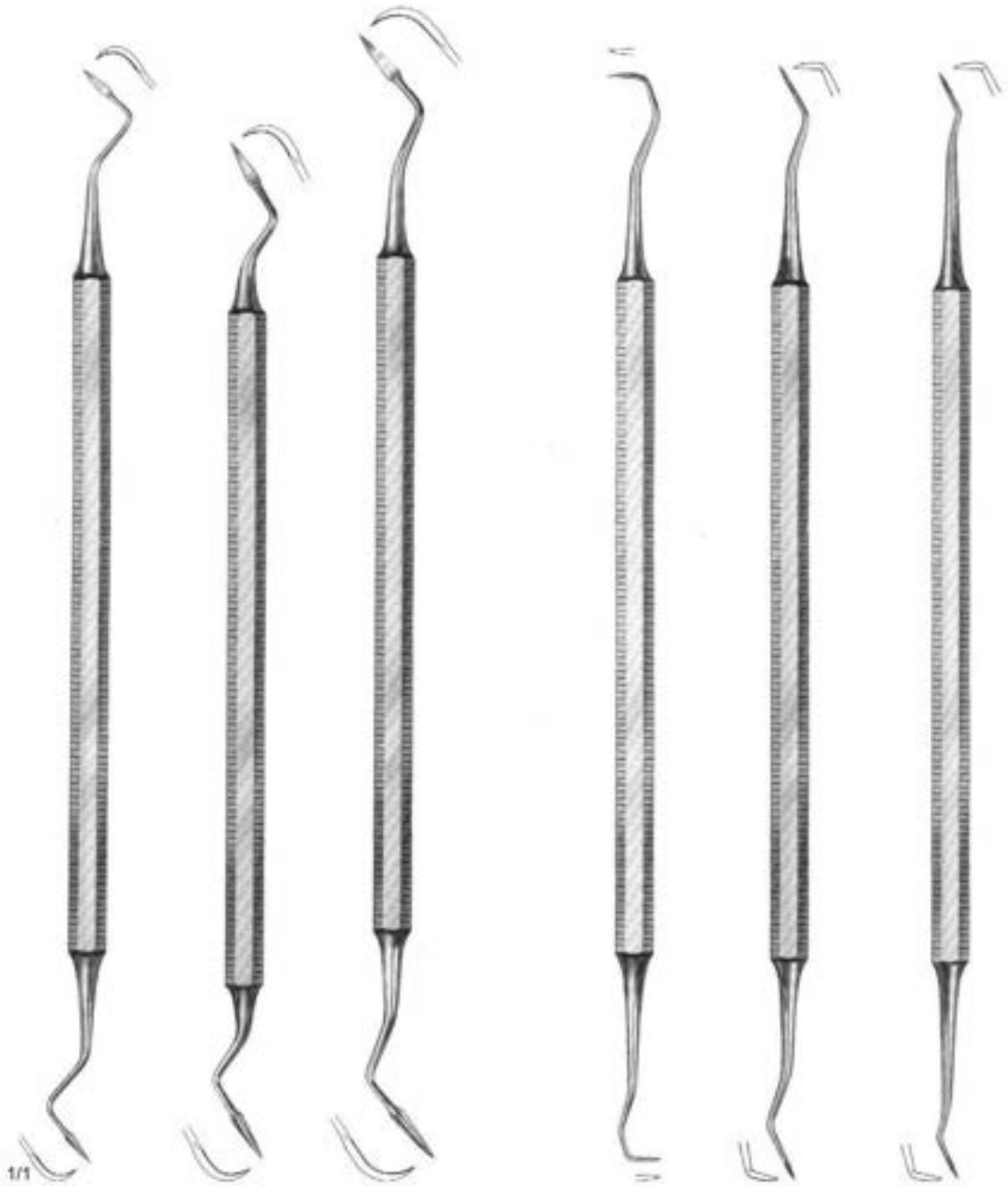
McCall
62-471-02
Fig. 13/14

Towner - Jaquette
62-471-30
Fig. 15/30

62-471-33
Fig. 5/33

Hygenist
62-475-07
Fig. 6/7

62-477-04
Fig. 204S



62-481-01
Fig. ST 2/3

62-481-02
Fig. SCI 2/3

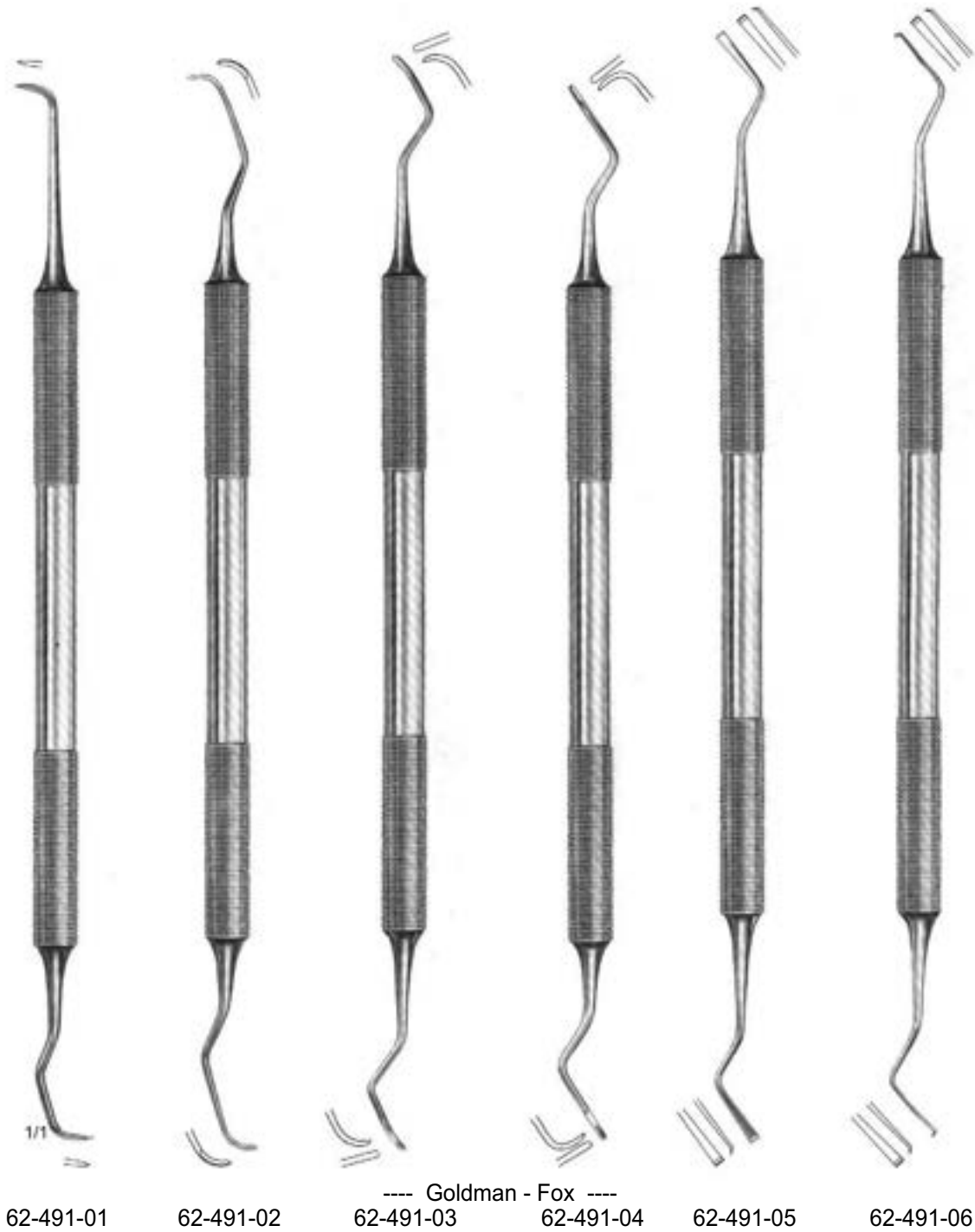
62-481-03
Fig. SCK 6

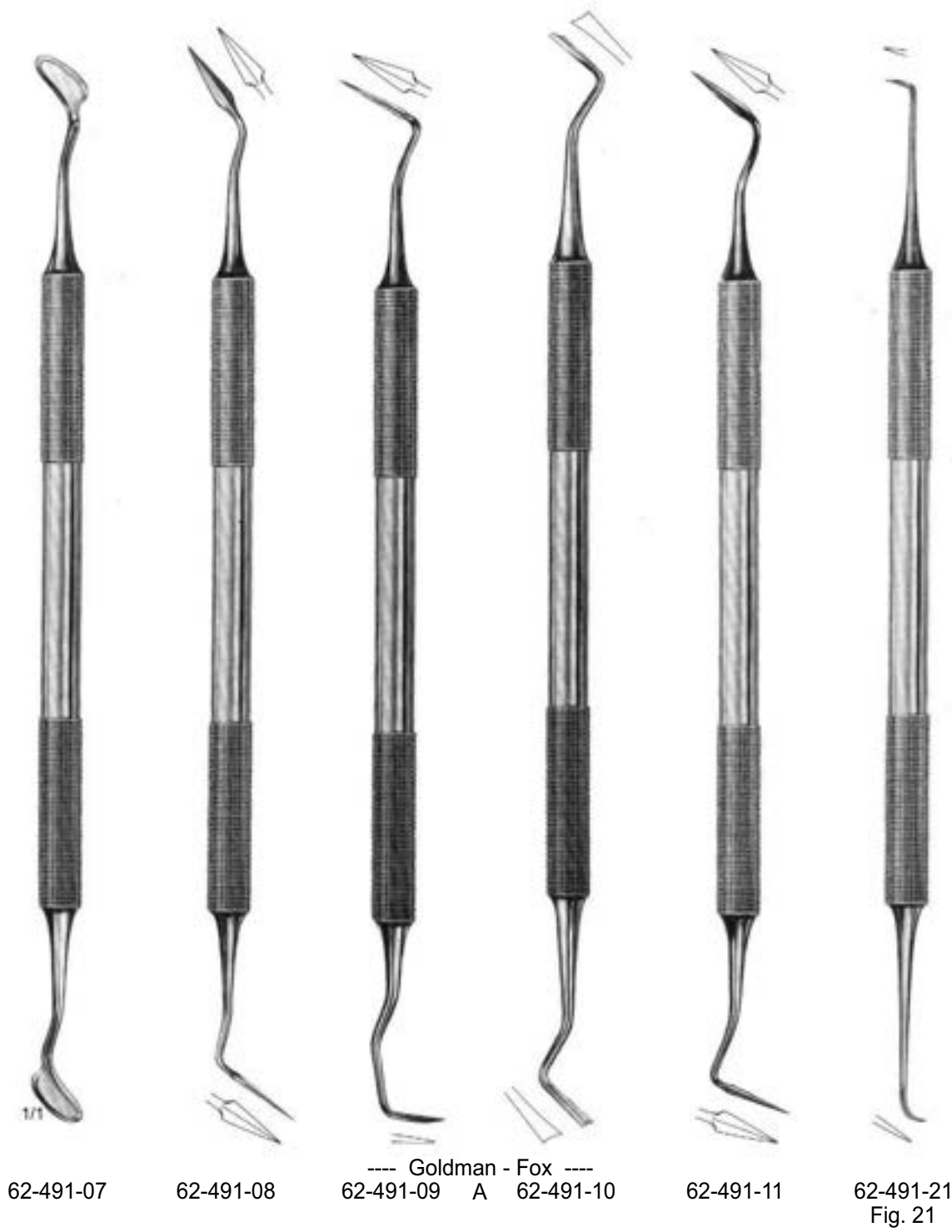
62-485-01
Fig. 30/33

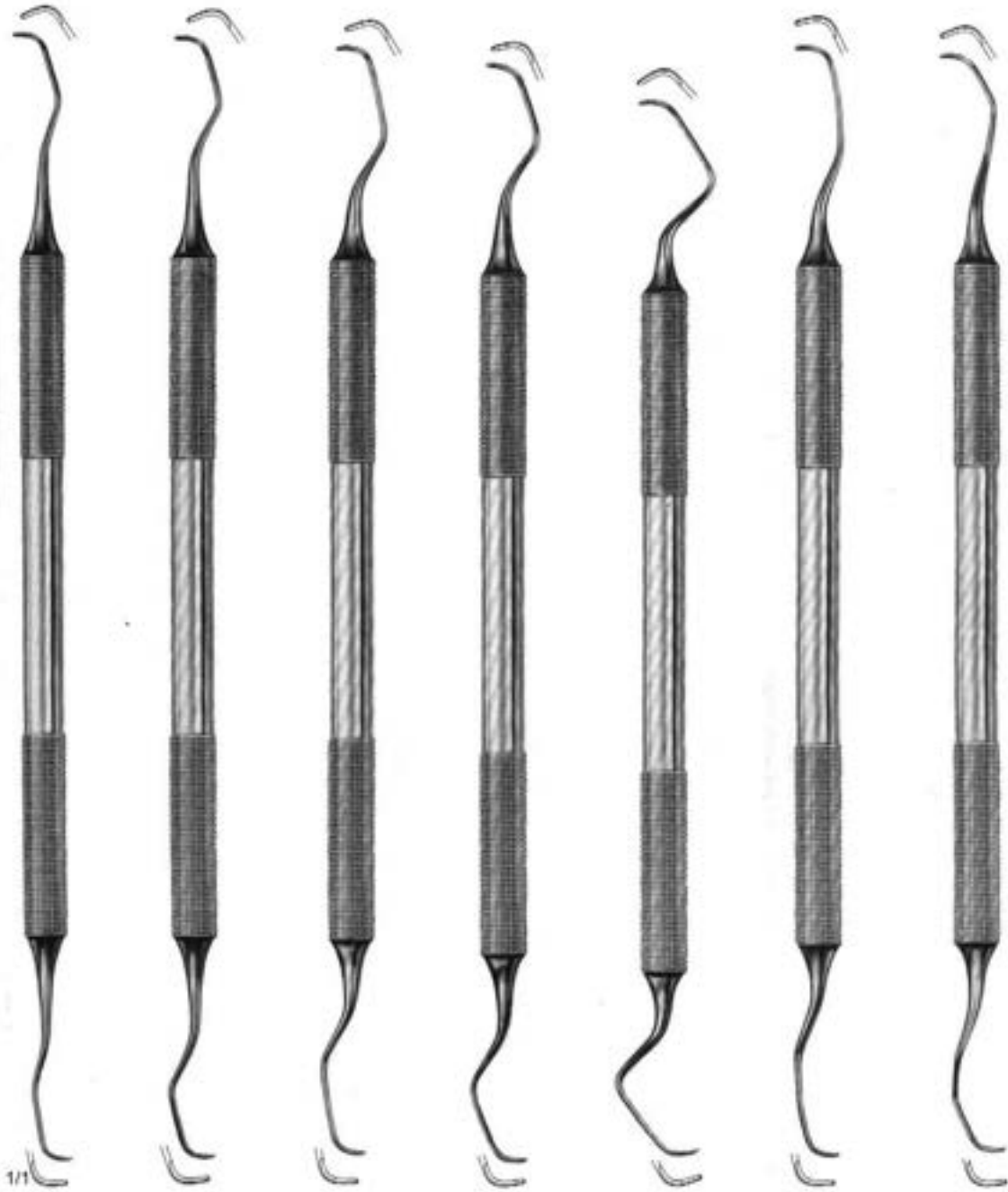
---- Jaquette ----

62-485-02
Fig. 31/32

62-485-03
Fig. 34/35







62-495-02
Fig. 1/2

62-495-04
Fig. 3/4

62-495-06
Fig. 5/6

---- Gracey ----
62-495-08
Fig. 7/8

62-495-10
Fig. 9/10

62-495-12
Fig. 11/12

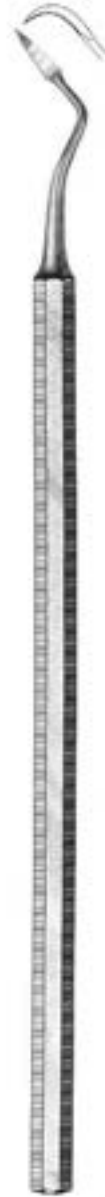
62-495-14
Fig. 13/14



62-503-04
Fig. SH5



Ward - Kirkland
62-531-01



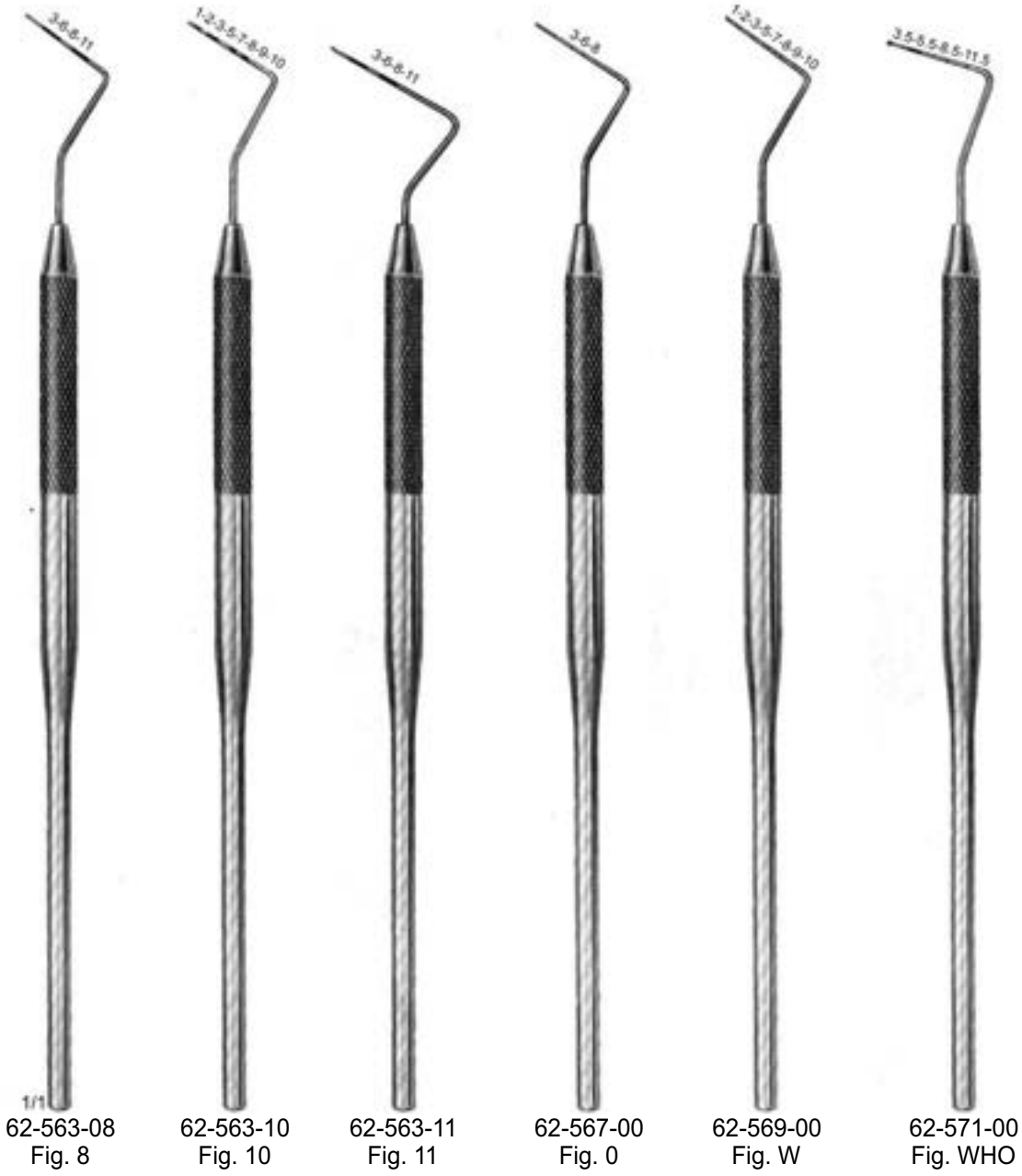
Crane - Kaplan
62-531-02

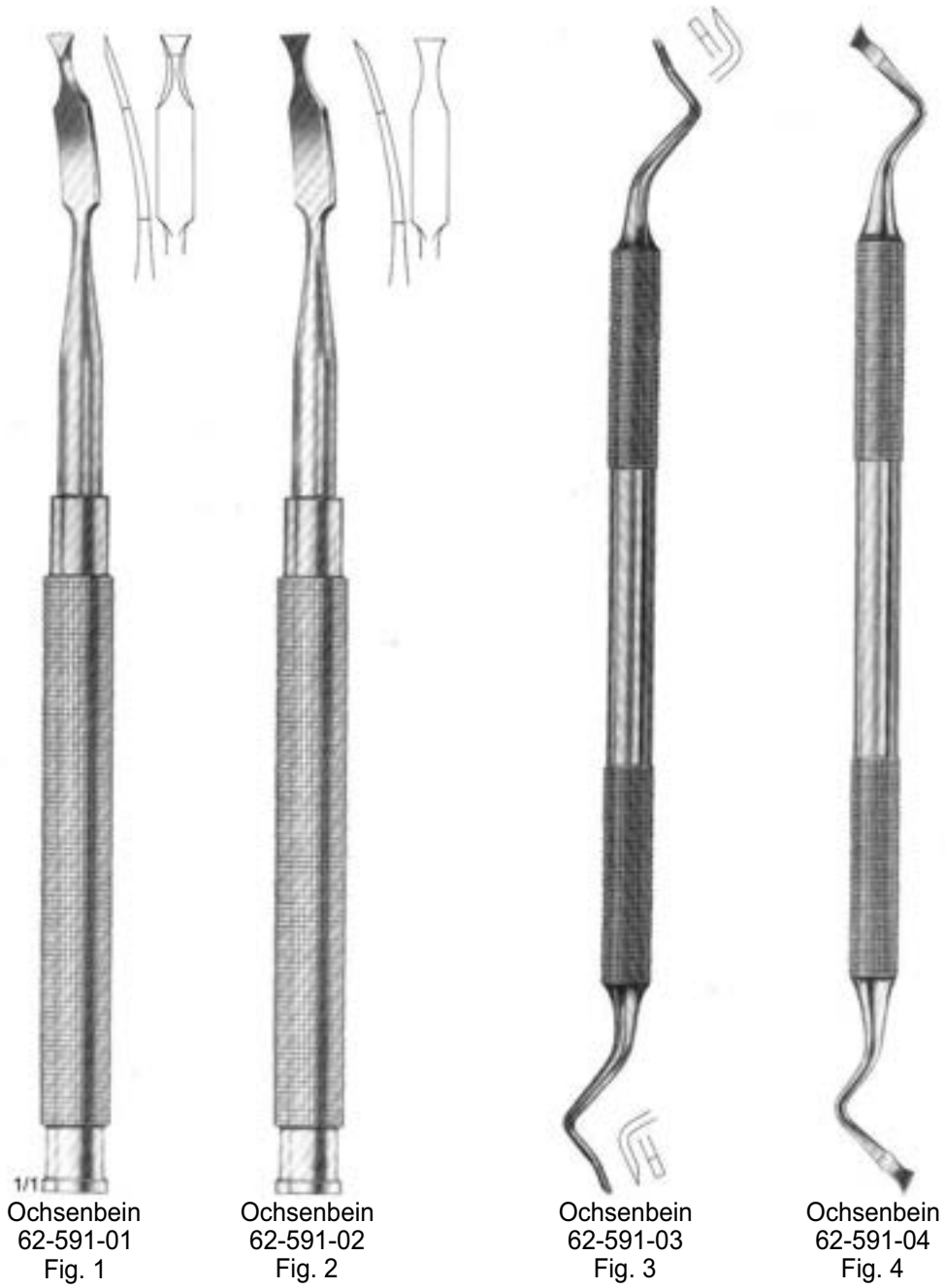


Crane - Kaplan
62-531-03











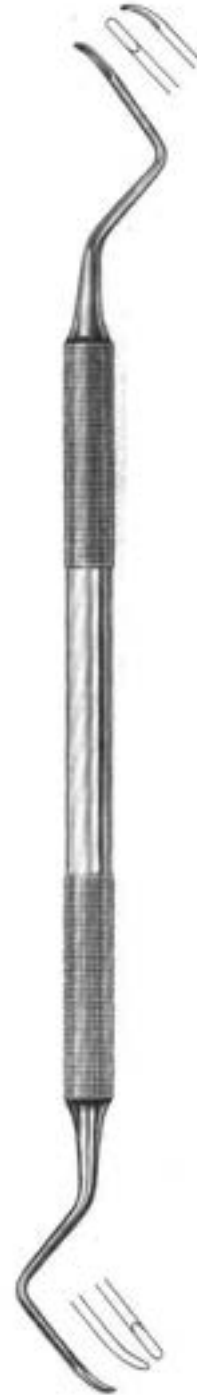
Fedi
62-595-01
Fig. 1



Fedi
62-595-02
Fig. 2



Fedi
62-595-03
Fig. 3



Prichard
62-597-00



I	62-701-03	62-701-06	62-701-17	62-701-23	62-701-33
II	62-703-03	62-703-06	62-703-17	62-703-23	62-703-33
	Fig. 3	Fig. 6	Fig. 17	Fig. 23	Fig. 33



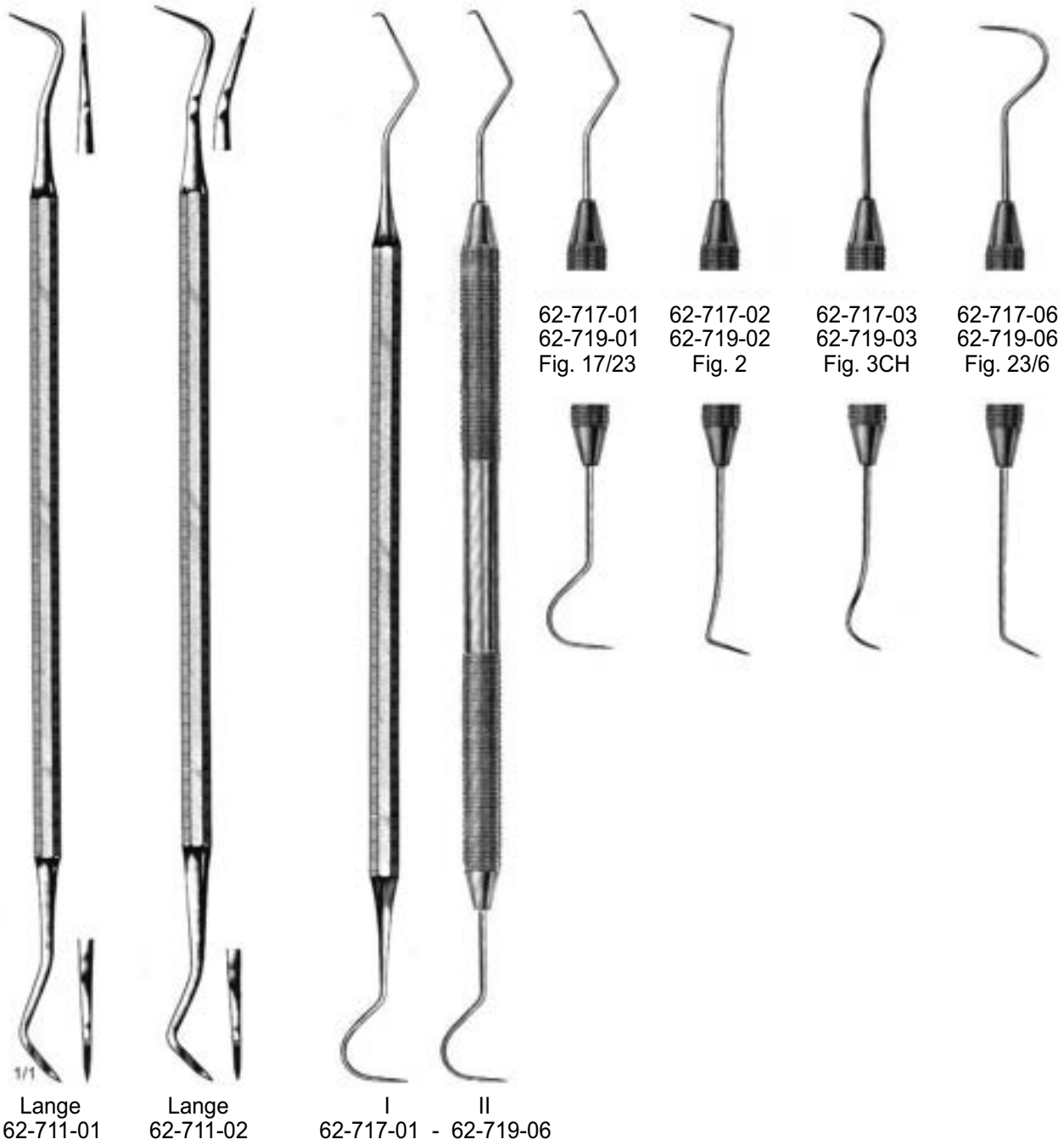
I
II
62-701-03 - 62-703-60

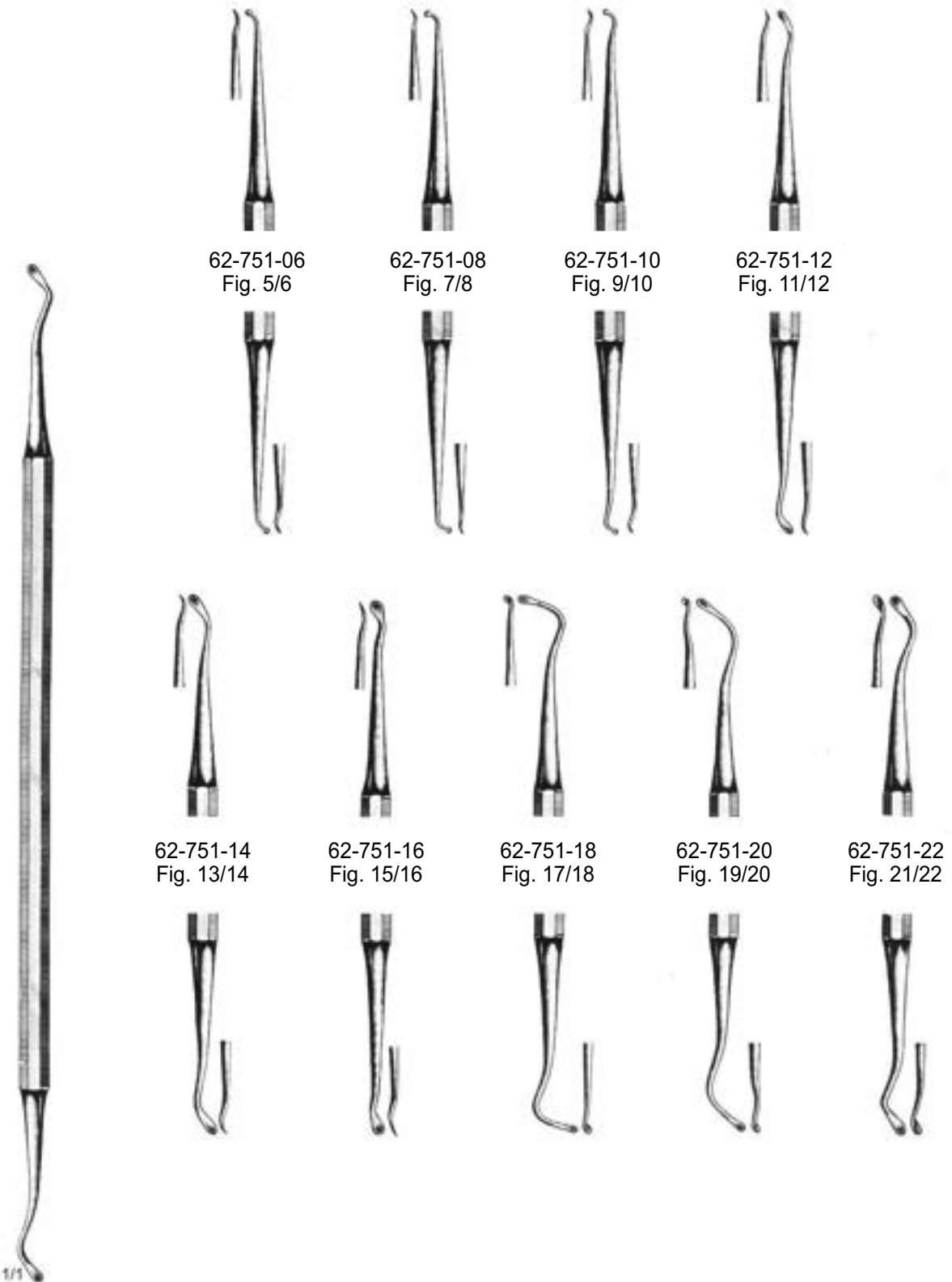


I	62-701-35	62-701-42	62-701-43	62-701-44	62-701-54
II	62-703-35	62-703-42	62-703-43	62-703-44	62-703-54
	Fig. 35	Fig. 42	Fig. 43	Fig. 44	Fig. 54



I	62-701-60	62-701-61	62-701-80	62-701-81	62-701-90
II	62-703-60	62-703-61	62-703-80	62-703-81	62-703-90
	Fig. 6	Fig. 6A	Fig. 8	Fig. 8A	Fig. 9





62-751-06
Fig. 5/6

62-751-08
Fig. 7/8

62-751-10
Fig. 9/10

62-751-12
Fig. 11/12

62-751-14
Fig. 13/14

62-751-16
Fig. 15/16

62-751-18
Fig. 17/18

62-751-20
Fig. 19/20

62-751-22
Fig. 21/22

Darby - Perry
62-751-06 - 62-751-22



62-761-13 - 62-761-80



62-761-13
Fig. 12/13



62-761-15
Fig. 14/15



62-761-72
Fig. 171/172



62-761-74
Fig. 173/174



62-761-76
Fig. 175/176

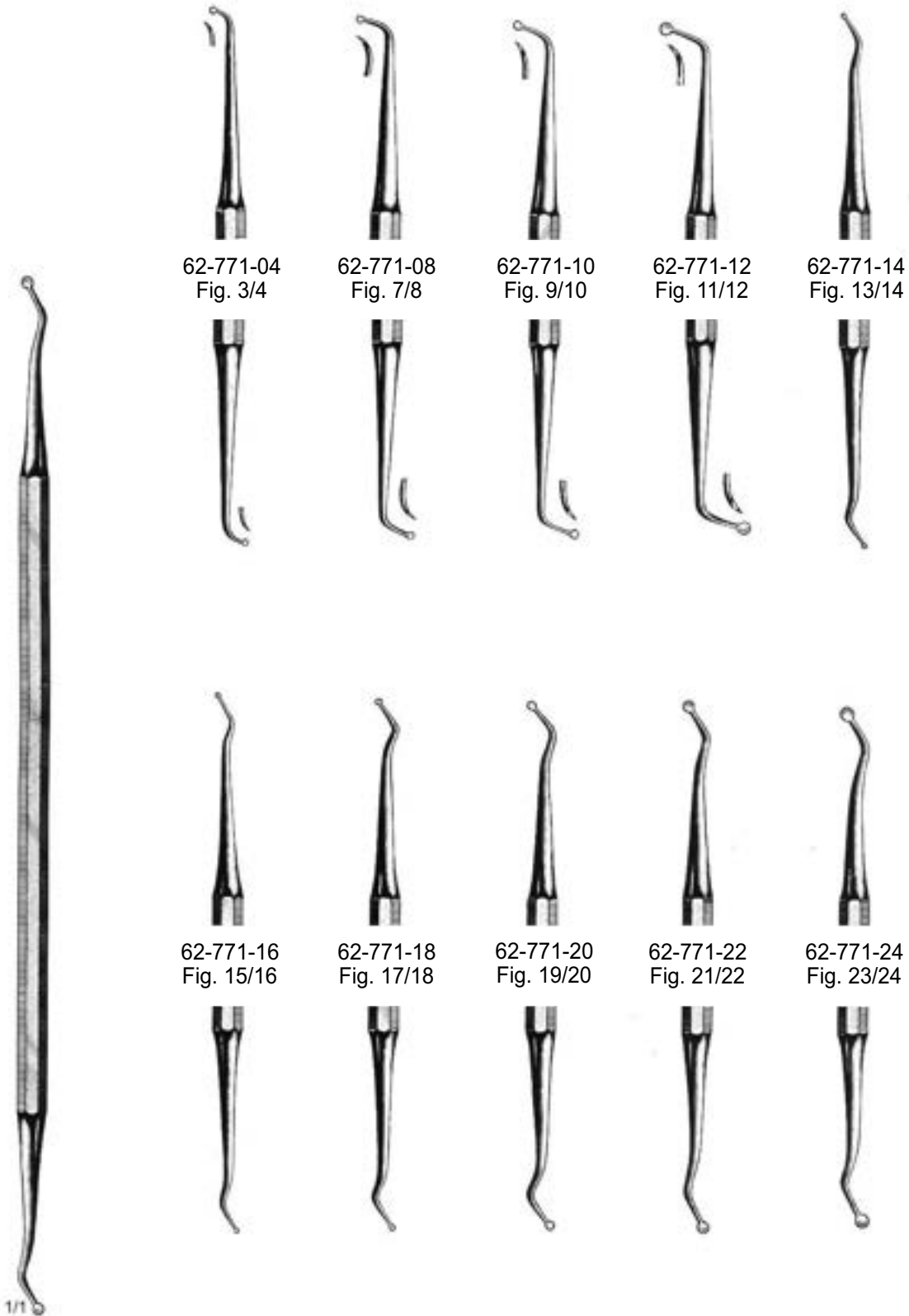


62-761-78
Fig. 177/178



62-761-80
Fig. 179/180





62-771-04
Fig. 3/4

62-771-08
Fig. 7/8

62-771-10
Fig. 9/10

62-771-12
Fig. 11/12

62-771-14
Fig. 13/14

62-771-16
Fig. 15/16

62-771-18
Fig. 17/18

62-771-20
Fig. 19/20

62-771-22
Fig. 21/22

62-771-24
Fig. 23/24

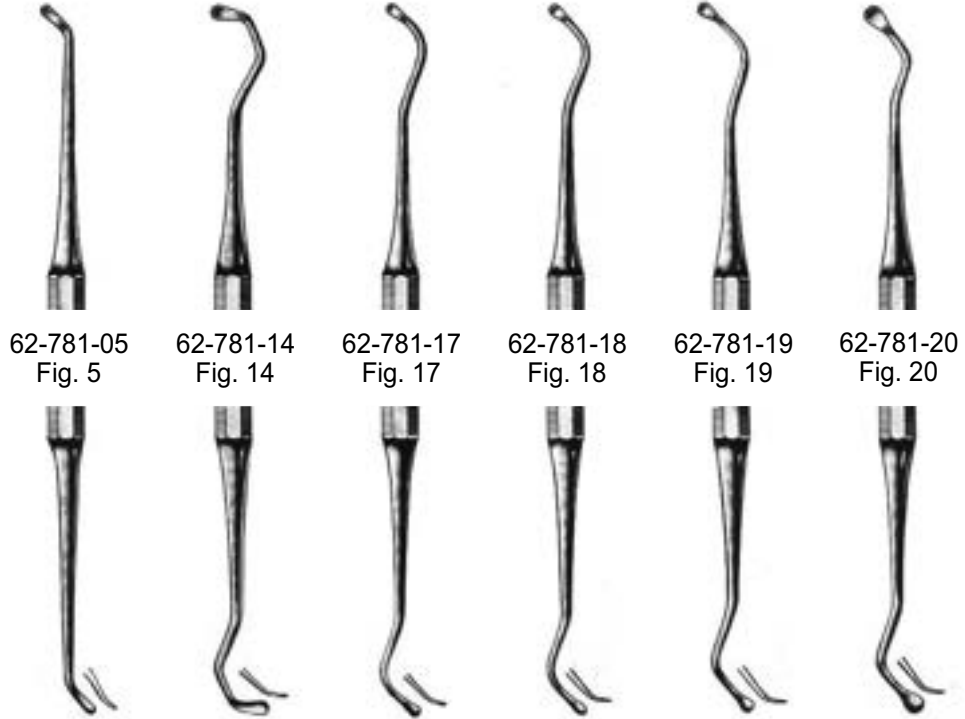
62-771-04 - 62-771-24



1/1

White

62-781-05 - 62-781-20



62-781-05
Fig. 5

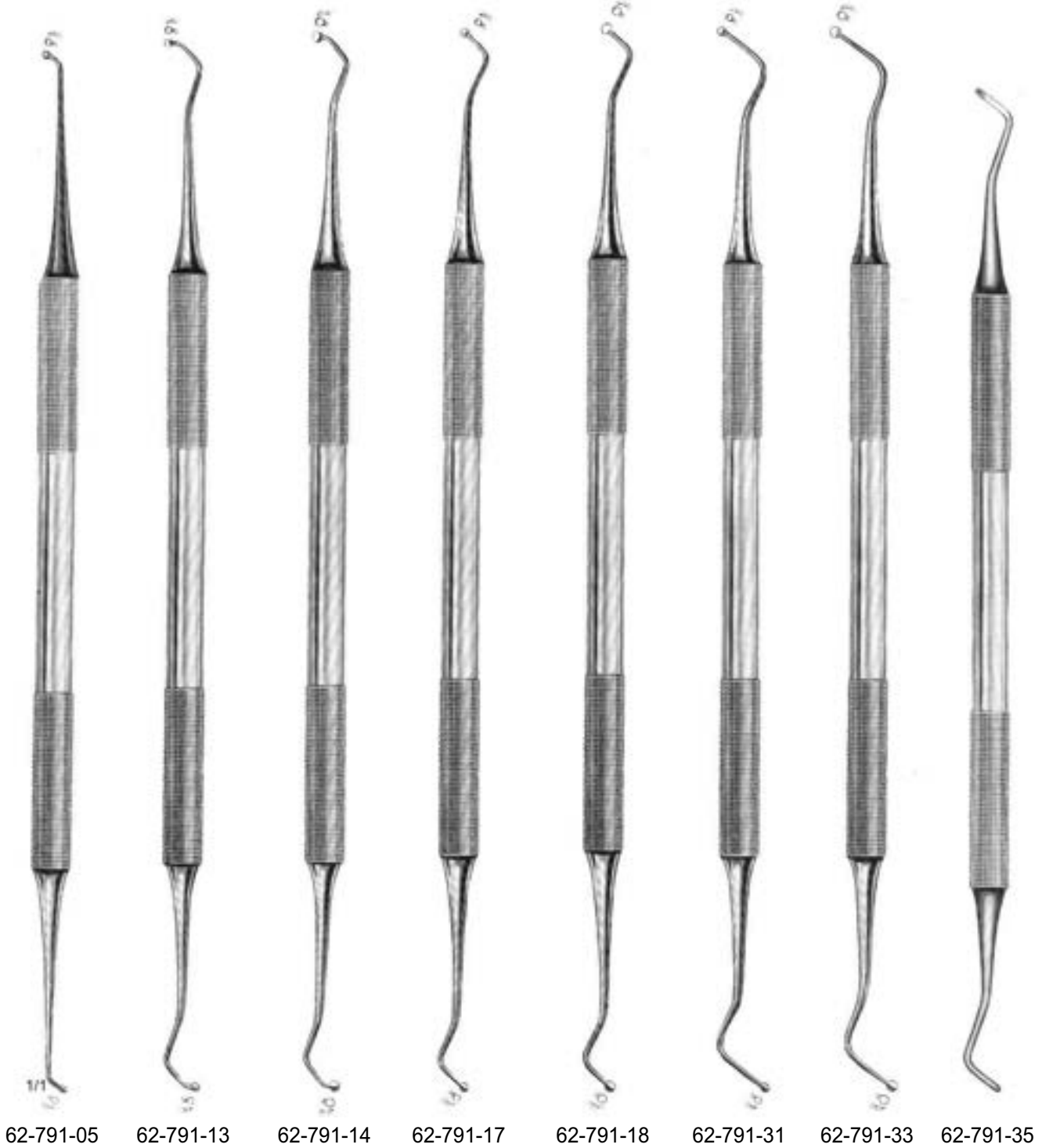
62-781-14
Fig. 14

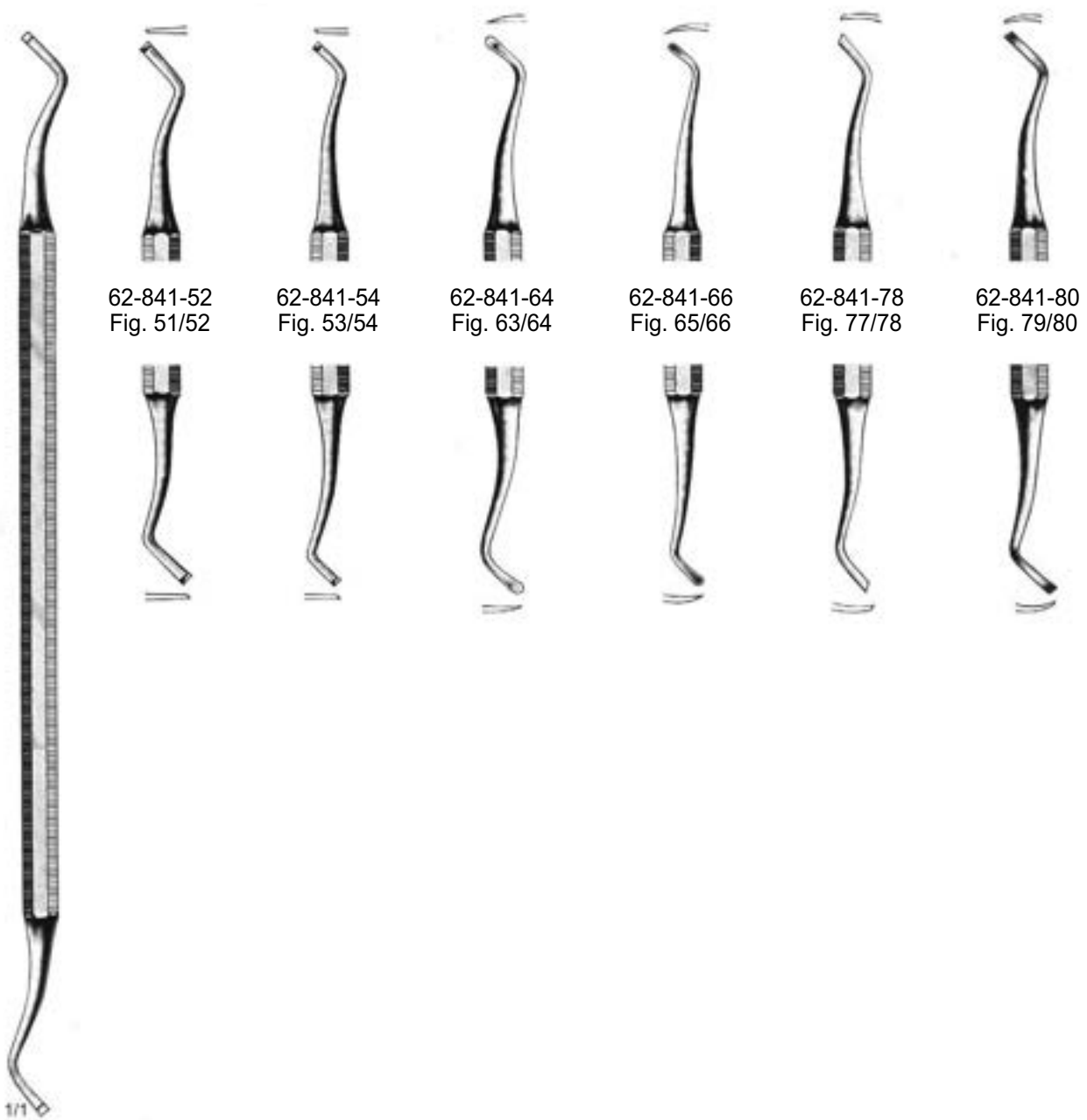
62-781-17
Fig. 17

62-781-18
Fig. 18

62-781-19
Fig. 19

62-781-20
Fig. 20





62-841-52
Fig. 51/52

62-841-54
Fig. 53/54

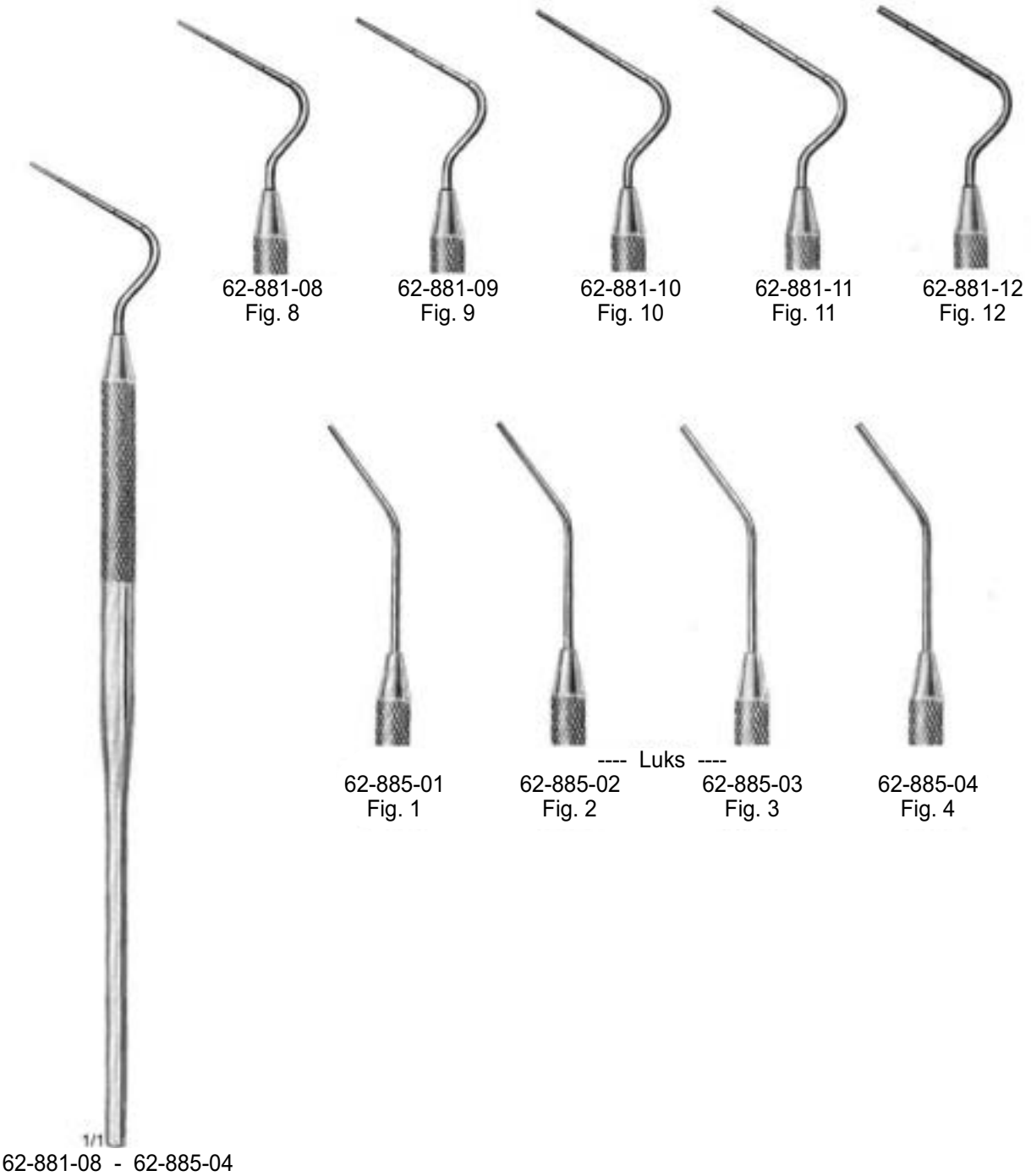
62-841-64
Fig. 63/64

62-841-66
Fig. 65/66

62-841-78
Fig. 77/78

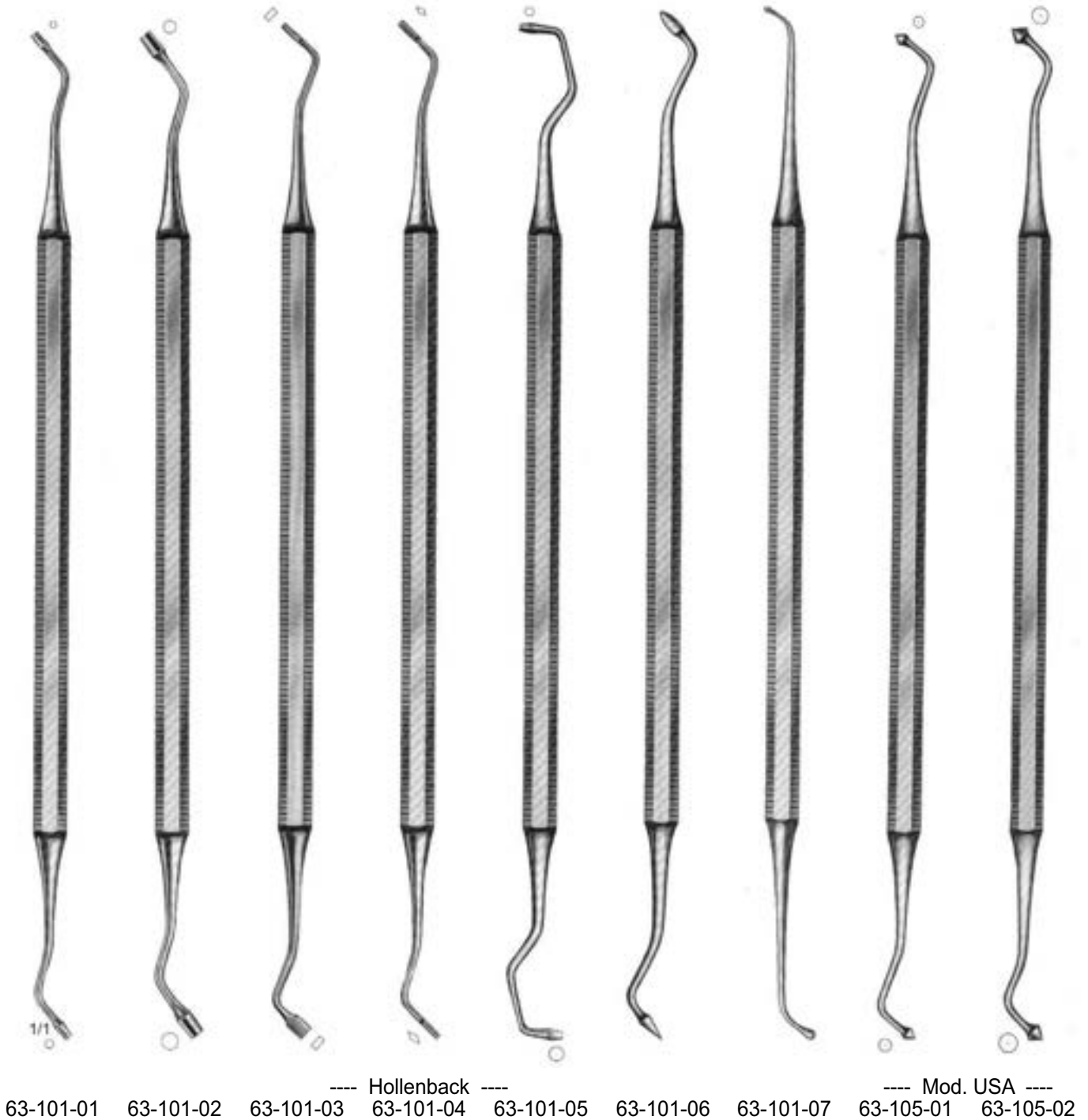
62-841-80
Fig. 79/80

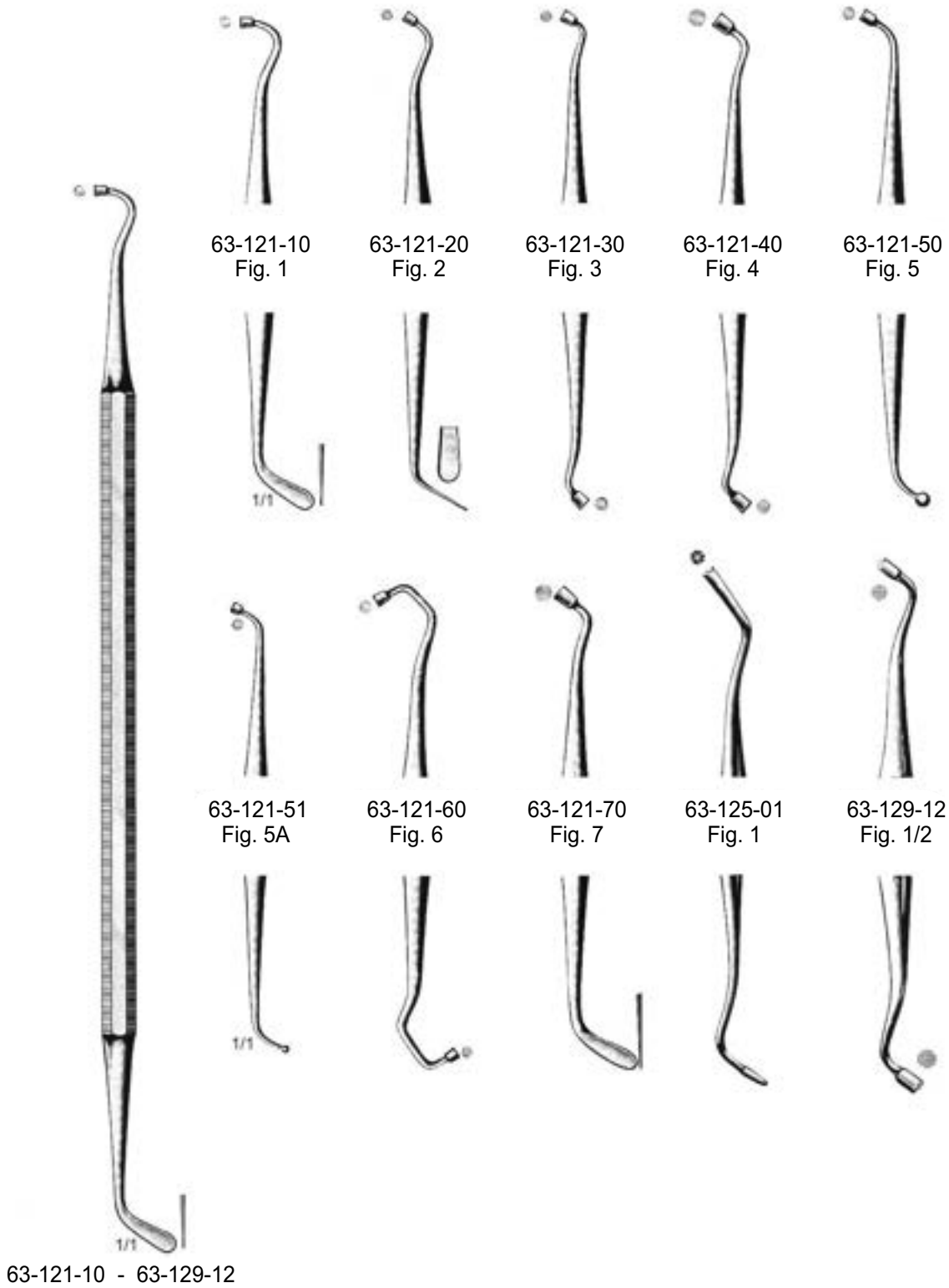
Black
62-841-52 - 62-841-80

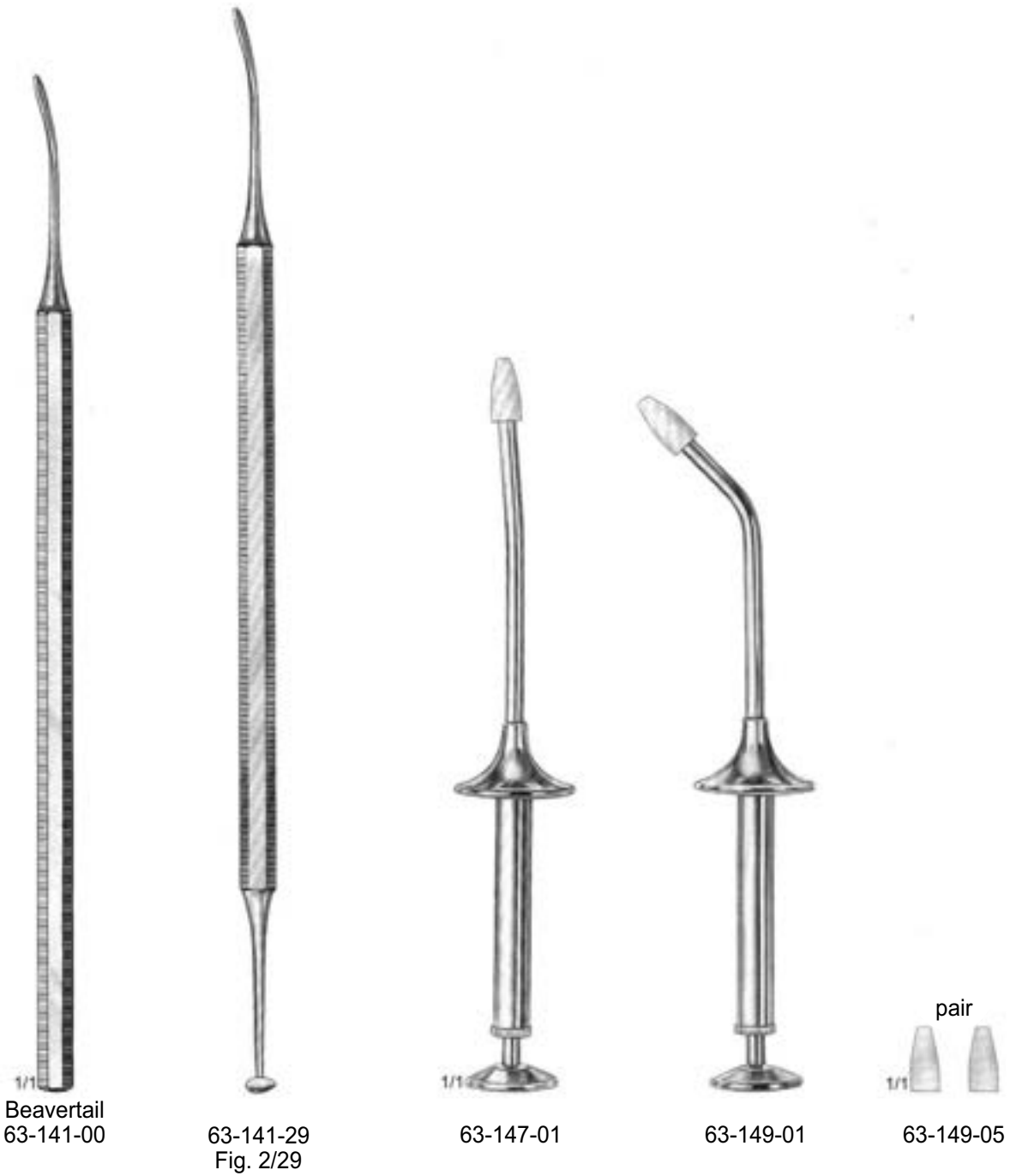




63









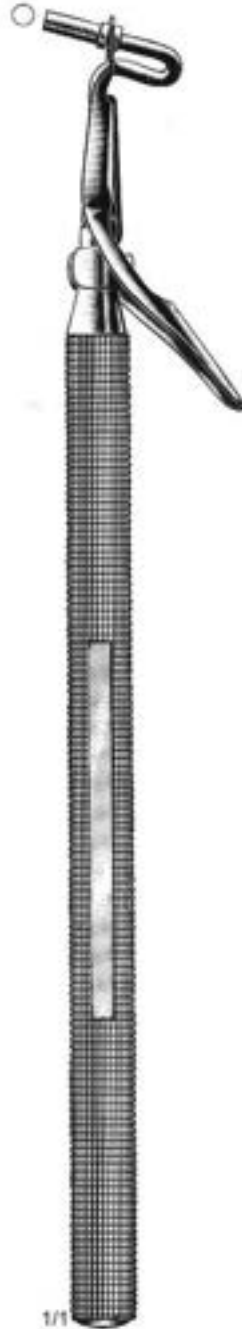
63-170-30
 Ø 30 mm



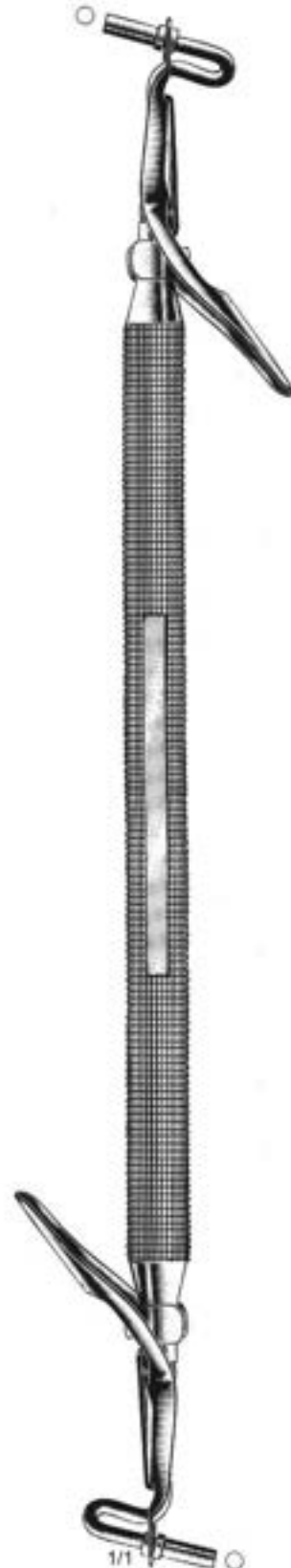
63-170-31
 Ø 30 mm



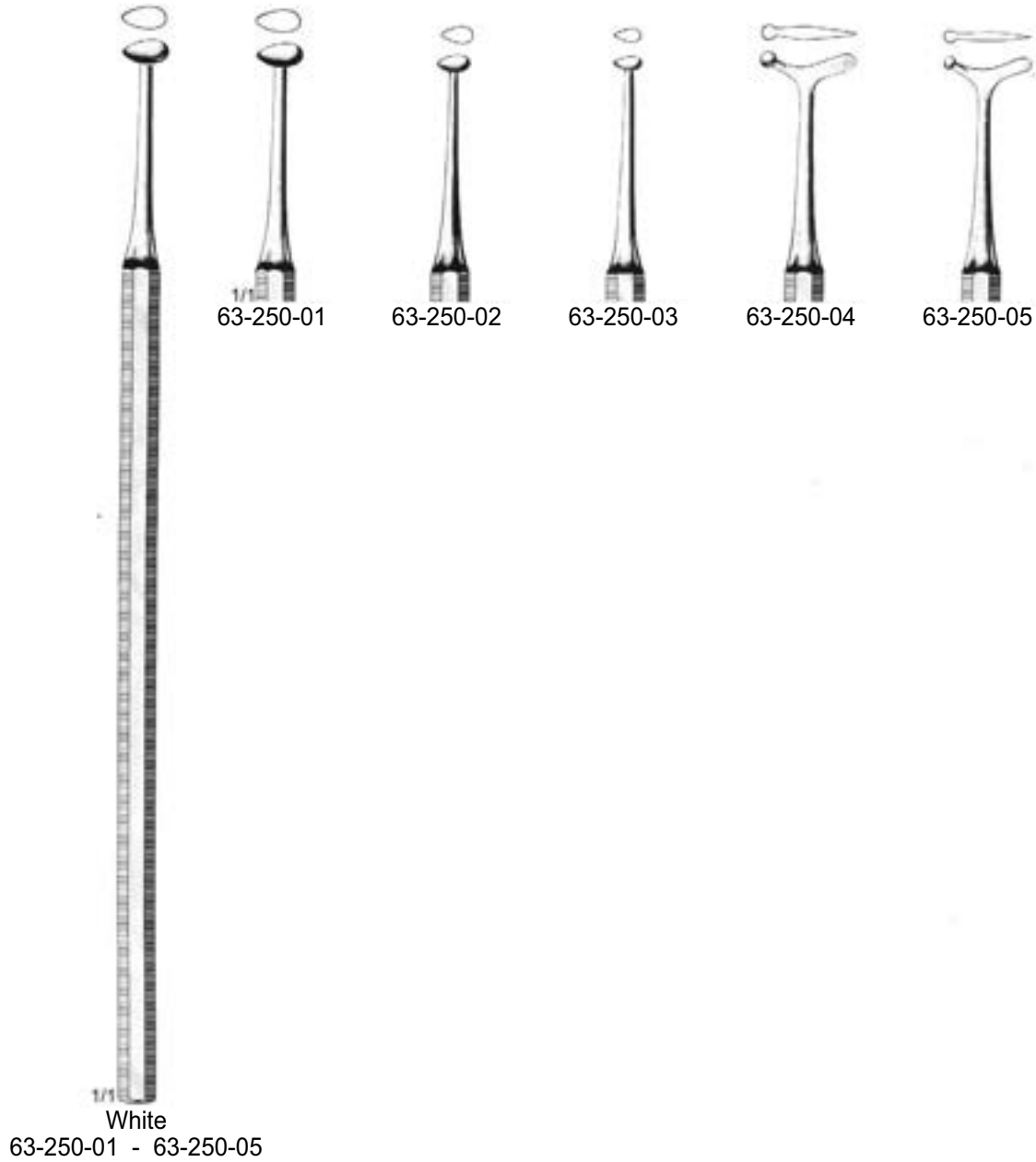
63-173-01

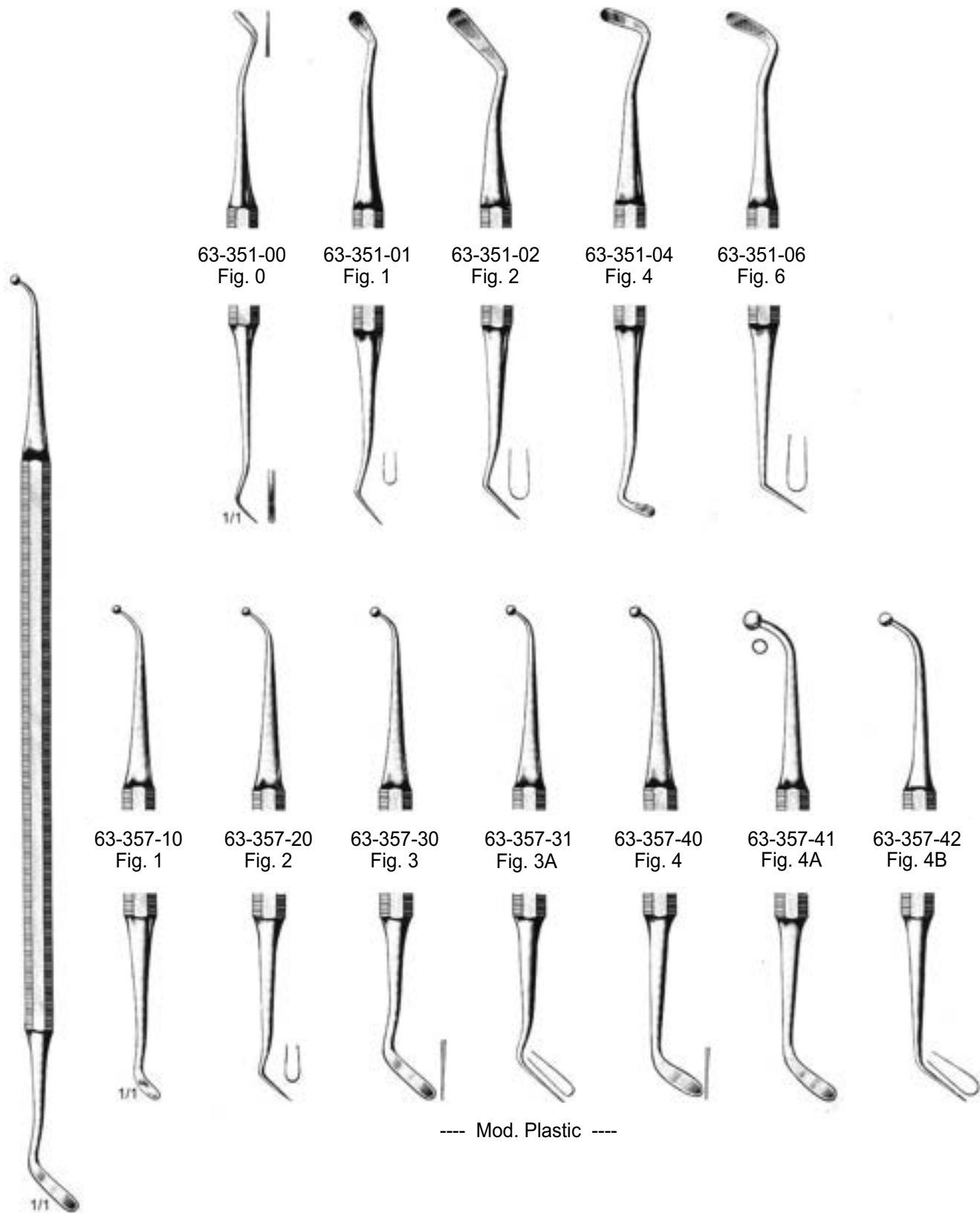


Ivory
 63-176-17

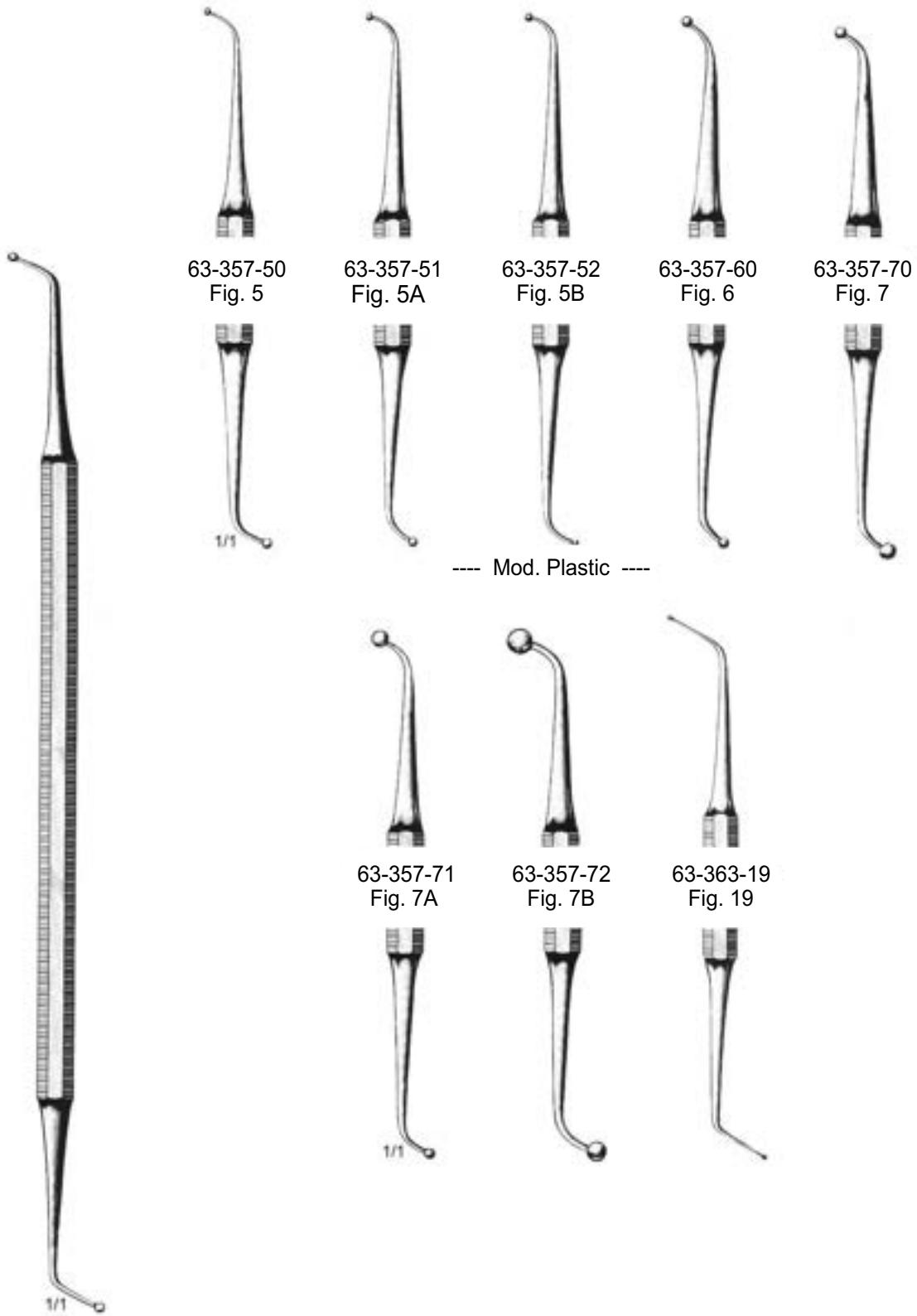


Ivory
 63-176-21

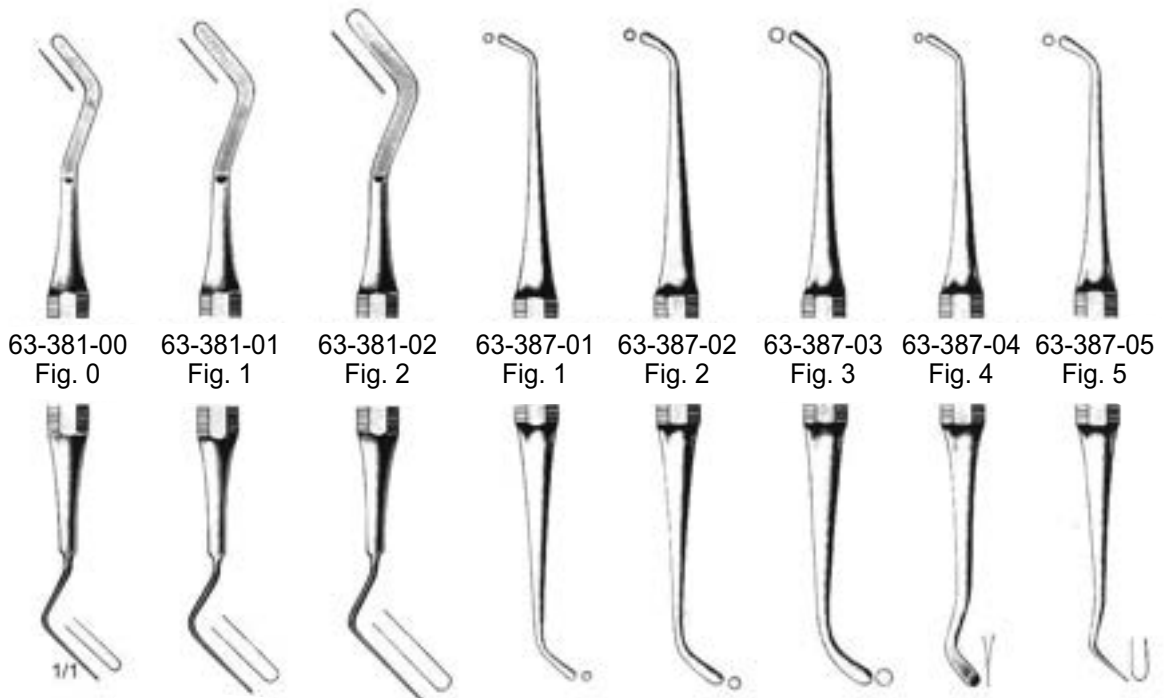




63-351-00 - 63-357-42

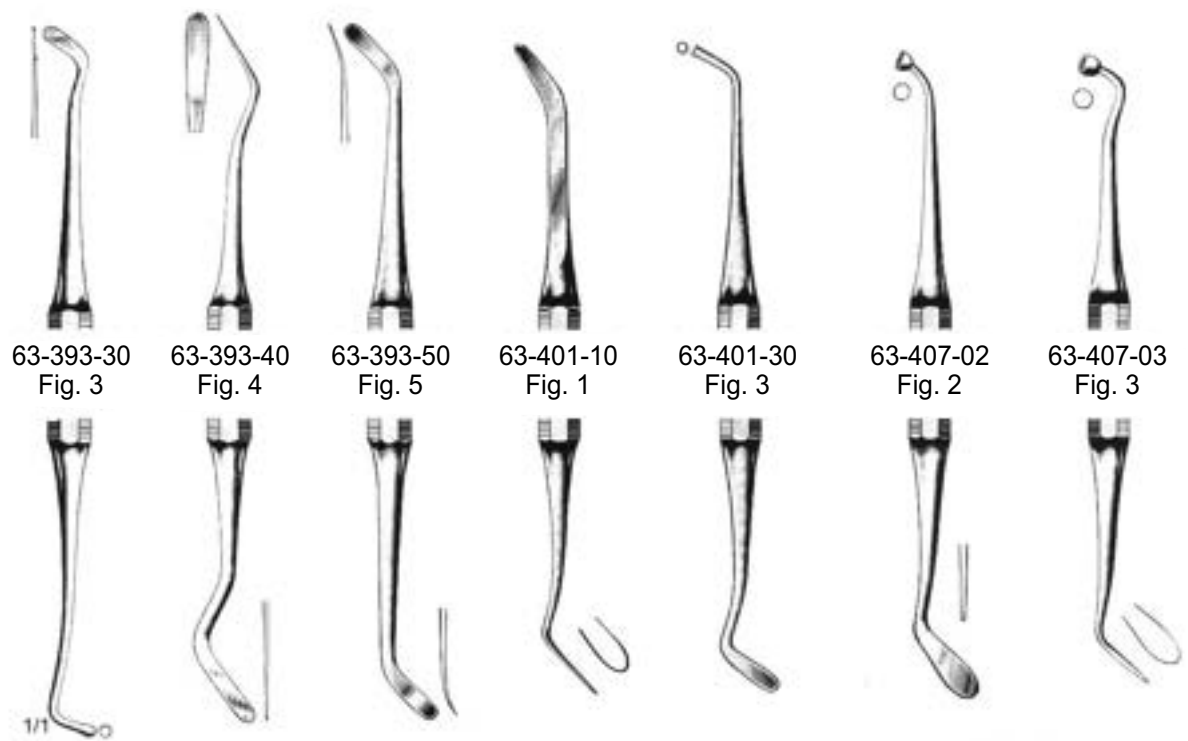


63-357-50 - 63-363-19



---- Heidemann ----

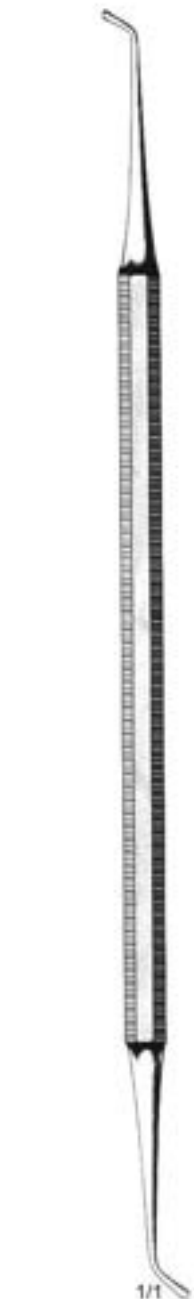
---- Ash ----



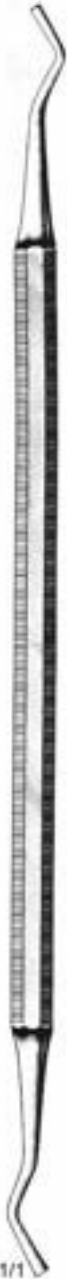
---- White ----

---- White ----

---- Woodson ----



63-381-00 - 63-407-03



63-421-00 - 63-425-07



63-421-00
Fig. 0



63-421-01
Fig. 1



63-421-02
Fig. 2

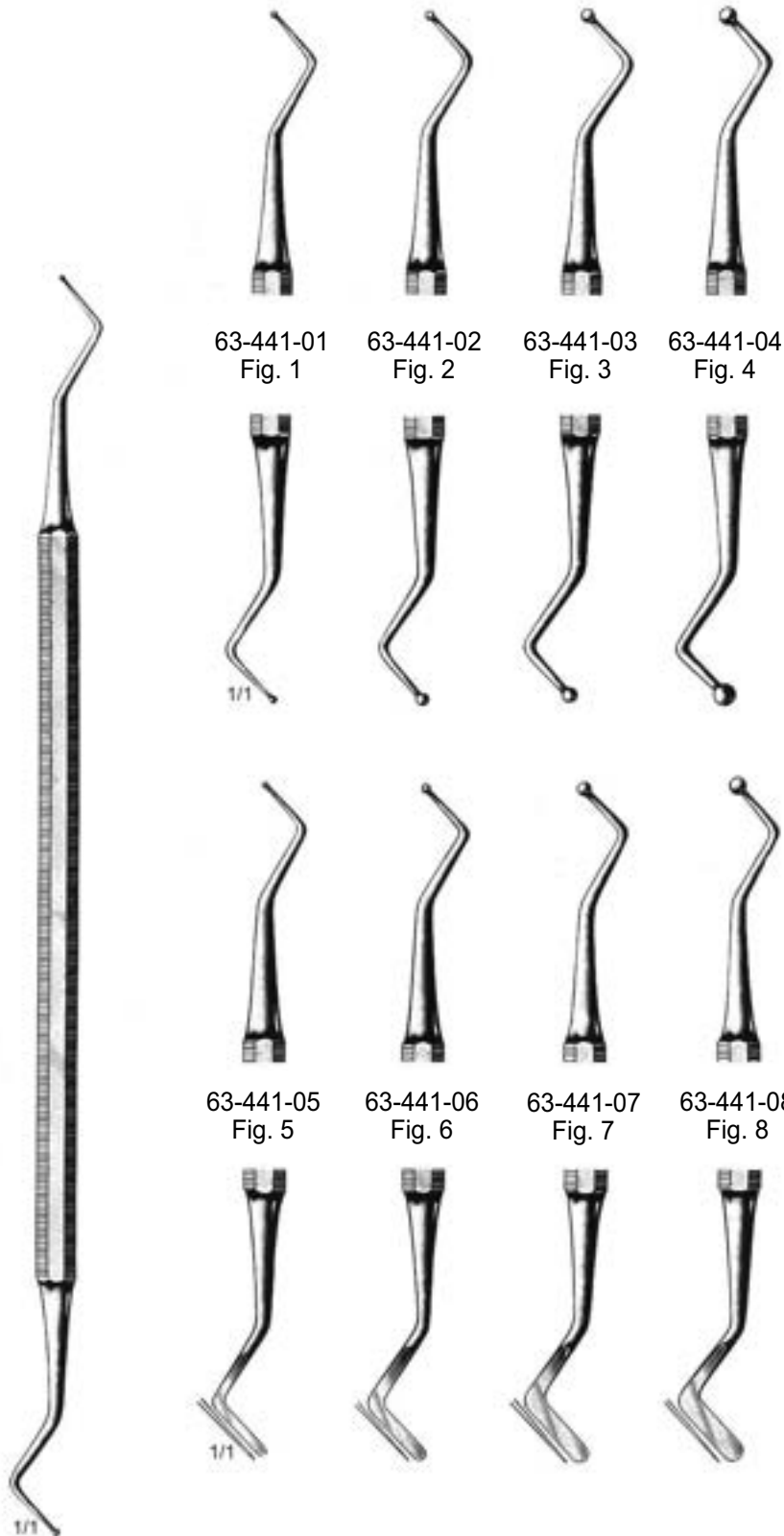


63-425-07
Fig. 7



---- Williams ----

Bennet



63-441-01
Fig. 1

63-441-02
Fig. 2

63-441-03
Fig. 3

63-441-04
Fig. 4

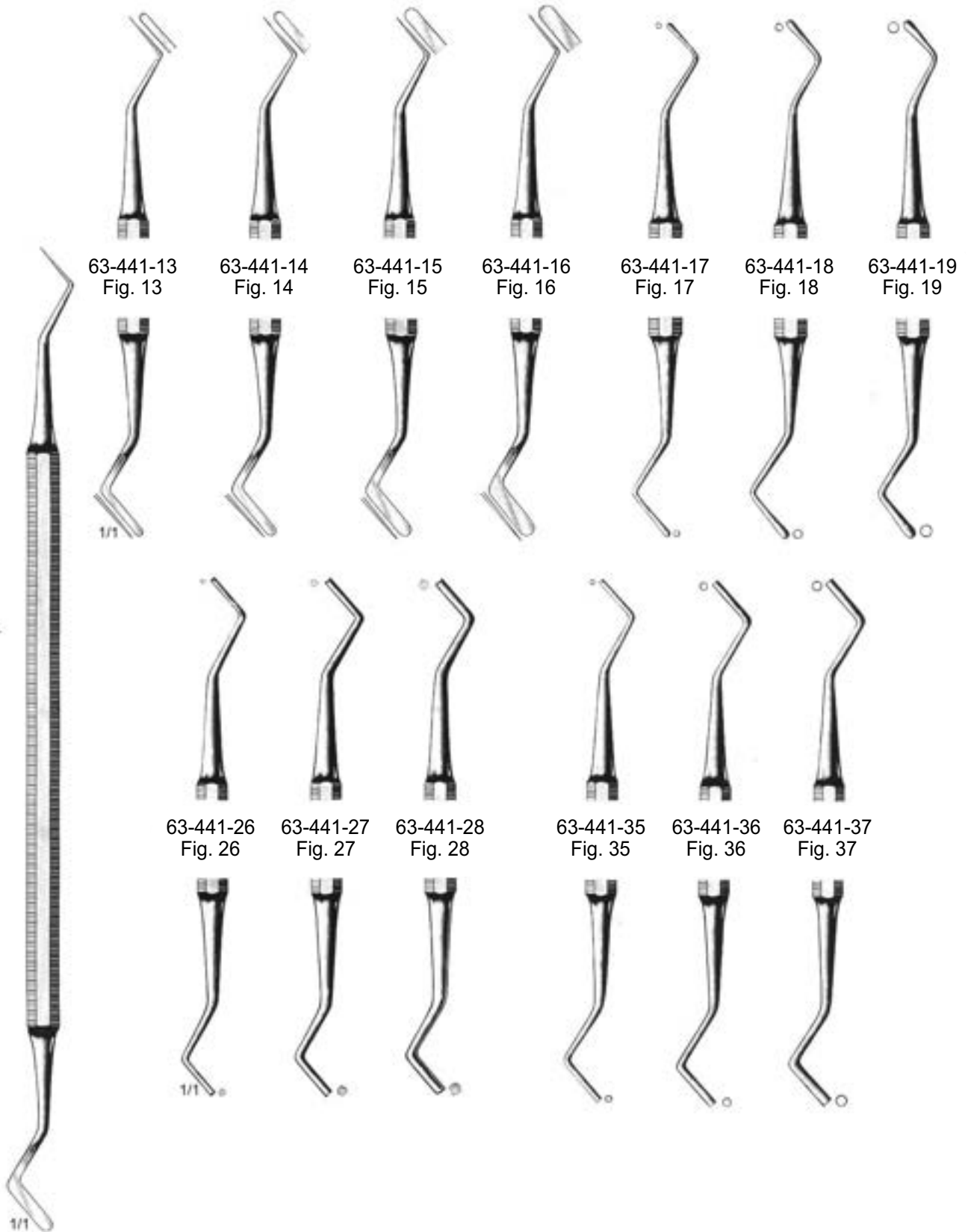
63-441-05
Fig. 5

63-441-06
Fig. 6

63-441-07
Fig. 7

63-441-08
Fig. 8

Martin - Axial
63-441-01 - 63-441-08



63-441-13 - 63-441-37





1/1
63-526-01 - 63-526-03



1/1
63-526-01
Fig. 1



63-526-02
Fig. 2



63-526-03
Fig. 3



1/1
63-540-01

without shields



Ivory
63-701-01
Fig. 1

with shields



Ivory
63-703-01
Fig. 12

with shields



Ivory
63-705-01
Fig. 12A

for molars



63-712-01
Fig. 1



63-712-02
Fig. 2



63-712-03
Fig. 3

for premolars



63-712-04
Fig. 4



63-712-05
Fig. 5



63-712-06
Fig. 6



1/1
 Ivory
 63-720-05 5 mm
 63-720-06 6 mm
 63-720-07 7 mm
 Fig. 8

for molars



63-724-07
 Fig. 7



63-724-08
 Fig. 8



63-724-09
 Fig. 9



63-724-10
 Fig. 10

for molars and premolars



63-724-11
 Fig. 11



63-724-12
 Fig. 12



63-724-13
 Fig. 13

mm x cm



1/2
 63-727-05 5 x 100
 63-727-06 6 x 100
 63-727-07 7 x 100



1/1
Tofflemire - Universal
63-750-05



Tofflemire
63-754-01
Fig. 1



Tofflemire
63-754-03
Fig. 3



1/1
Tofflemire
63-754-02
Fig. 2



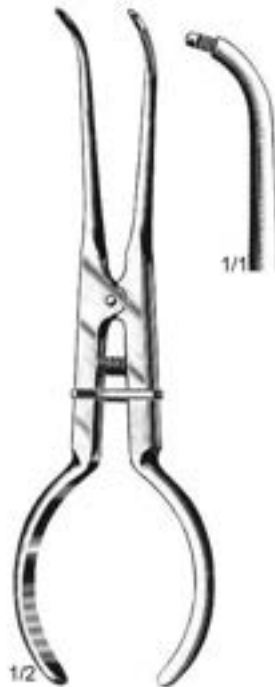
Tofflemire
63-754-04
Fig. 4



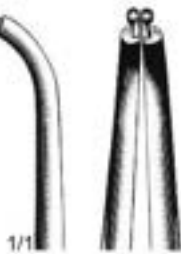
Ainsworth
63-800-16
16 cm



63-804-15
15 cm



Stockes
63-809-17
17 cm



63-813-16
16 cm



Brewer
63-817-17
17 cm

Rubber Dam Clamps
For molars # 26, 28, 30 right
31 left, 51 lower
For bicuspids # 27, 29, 60



63-862-26
Fig. 26



63-862-27
Fig. 27



63-862-28
Fig. 28



63-862-29
Fig. 29



63-862-30
Fig. 30



63-862-31
Fig. 31



63-862-51
Fig. 51



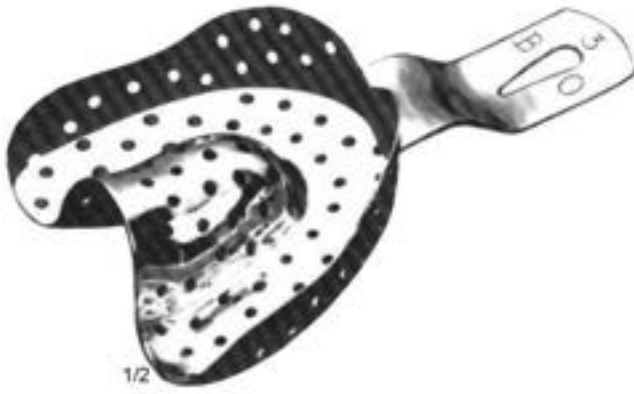
63-862-60
Fig. 60



Wizard
63-860-00

64

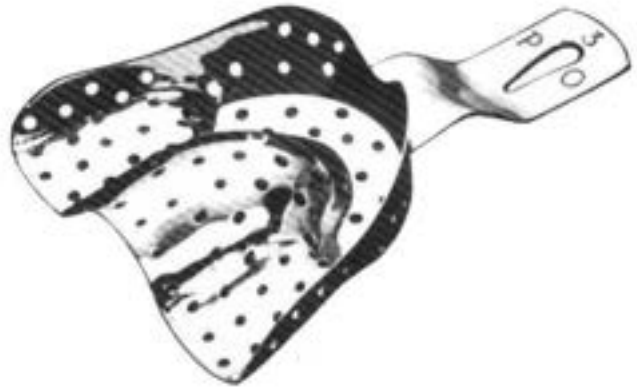
for toothed upper jaws, perforated



Form BO (SUP/B)

- 64-101-00 Fig. 0
- 64-101-01 Fig. 1
- 64-101-02 Fig. 2
- 64-101-03 Fig. 3
- 64-101-04 Fig. 4

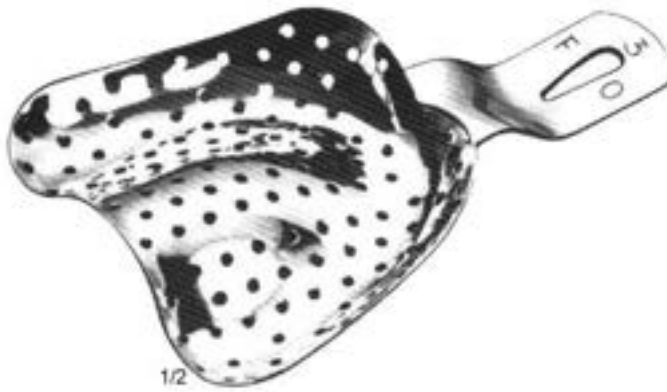
for partially toothed upper jaws, perforated



Form PO (SUP/P)

- 64-105-01 Fig. 1
- 64-105-02 Fig. 2
- 64-105-03 Fig. 3

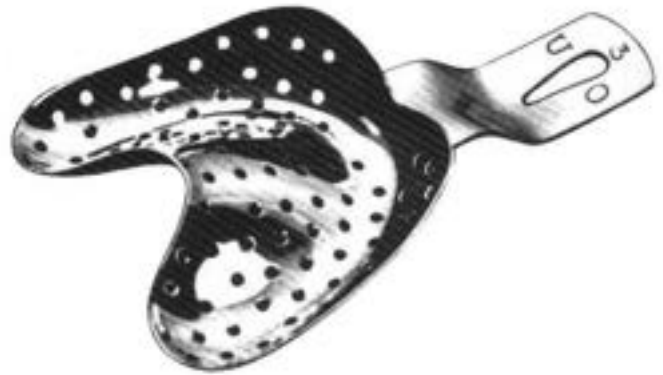
for functional impressions upper, perforated



Form FO (SUP/F)

- 64-111-01 Fig. 1
- 64-111-02 Fig. 2
- 64-111-03 Fig. 3

for edentulous upper jaws, perforated



Form UO (SUP/U)

- 64-115-01 Fig. 1
- 64-115-02 Fig. 2
- 64-115-03 Fig. 3

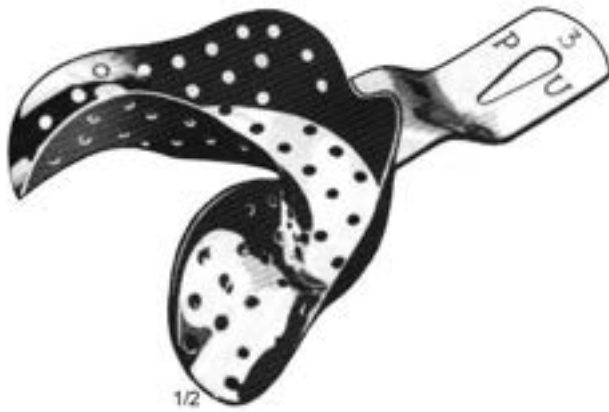
for toothed lower jaws, perforated



Form BU (INF/B)

- 64-121-00 Fig. 0
- 64-121-01 Fig. 1
- 64-121-02 Fig. 2
- 64-121-03 Fig. 3
- 64-121-04 Fig. 4

for partially toothed lower jaws, perforated



Form PU (INF/P)

- 64-125-01 Fig. 1
- 64-125-02 Fig. 2
- 64-125-03 Fig. 3

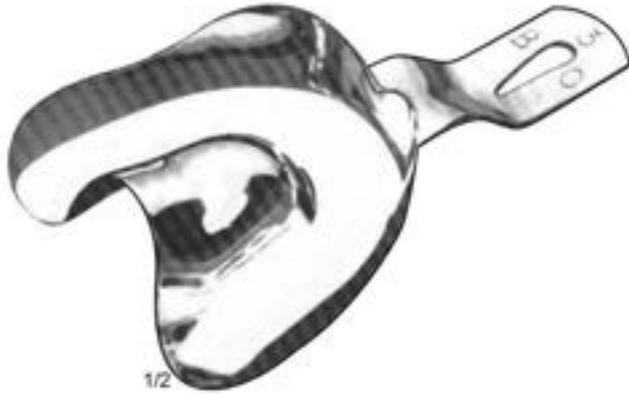
for edentulous lower jaws, perforated



Form UU (INF/U)

- 64-131-01 Fig. 1
- 64-131-02 Fig. 2
- 64-131-03 Fig. 3

for toothed upper jaws, unperforated



Form BO (SUP/B)

64-171-00 Fig. 0
64-171-01 Fig. 1
64-171-02 Fig. 2
64-171-03 Fig. 3
64-171-04 Fig. 4

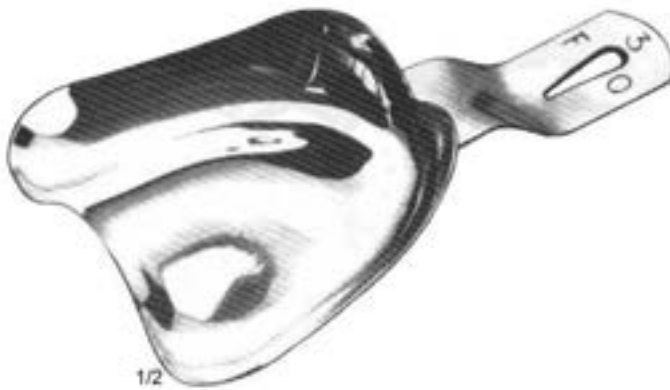
for partially toothed upper jaws, unperforated



Form PO (SUP/P)

64-175-01 Fig. 1
64-175-02 Fig. 2
64-175-03 Fig. 3

for functional impressions upper, unperforated



Form FO (SUP/F)

64-181-01 Fig. 1
64-181-02 Fig. 2
64-181-03 Fig. 3

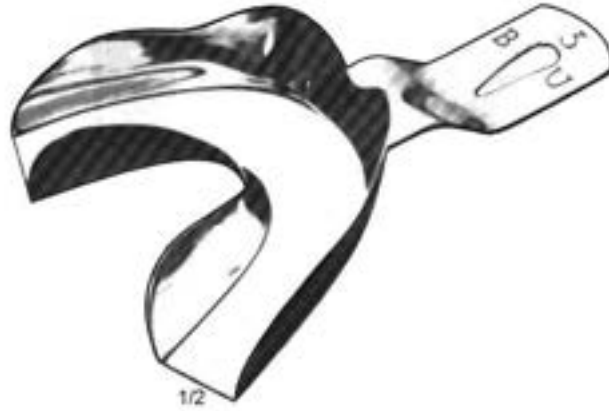
for edentulous upper jaws, unperforated



Form UO (SUP/U)

64-185-01 Fig. 1
64-185-02 Fig. 2
64-185-03 Fig. 3

for toothed lower jaws, unperforated



Form BU (INF/B)

- 64-191-00 Fig. 0
- 64-191-01 Fig. 1
- 64-191-02 Fig. 2
- 64-191-03 Fig. 3
- 64-191-04 Fig. 4

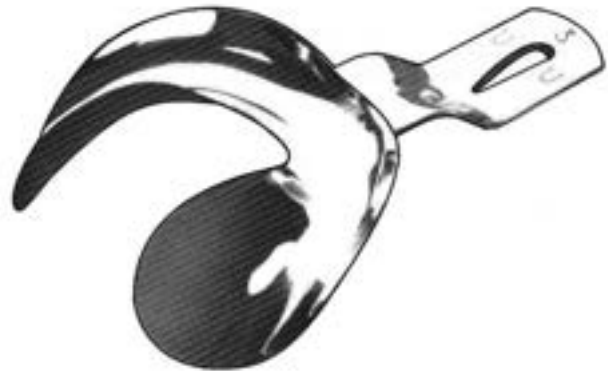
for partially toothed lower jaws, unperforated



Form FO (SUP/F)

- 64-111-01 Fig. 1
- 64-111-02 Fig. 2
- 64-111-03 Fig. 3

for edentulous lower jaws, unperforated



Form UU (INF/U)

- 64-201-01 Fig. 1
- 64-201-02 Fig. 2
- 64-201-03 Fig. 3

perforated

unperforated



1/2

Form C 1/2 R

- | | | | |
|-----------|--------|-----------|--------|
| 64-251-01 | Fig. 1 | 64-253-01 | Fig. 1 |
| 64-251-02 | Fig. 2 | 64-253-02 | Fig. 2 |
| 64-251-03 | Fig. 3 | 64-253-03 | Fig. 3 |

perforated

unperforated



Form C 1/2 L

- | | | | |
|-----------|--------|-----------|--------|
| 64-261-01 | Fig. 1 | 64-263-01 | Fig. 1 |
| 64-261-02 | Fig. 2 | 64-263-02 | Fig. 2 |
| 64-261-03 | Fig. 3 | 64-263-03 | Fig. 3 |

with swivel handle and fixing screw

with swivel handle



64-271-01



64-273-01



64-281-01



64-283-01

with swivel handle and slide



64-291-01



64-293-01



Schwarz
 64-400-17
 17 cm

acrylic glass



64-410-13
 Ø 130 mm

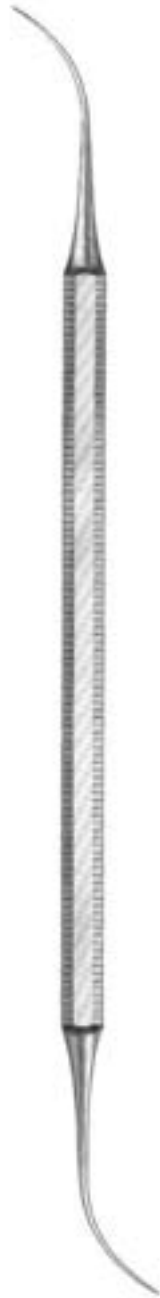
soft rubber

64-414-13
 Ø 130 mm

plastic



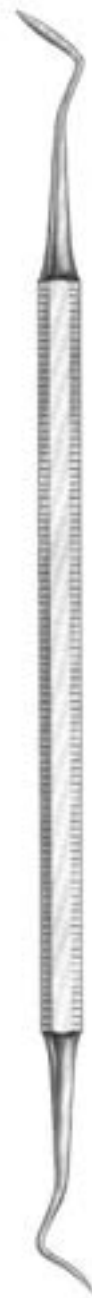
1/1
Thomas
64-501-01



Thomas
64-501-02



Thomas
64-501-03



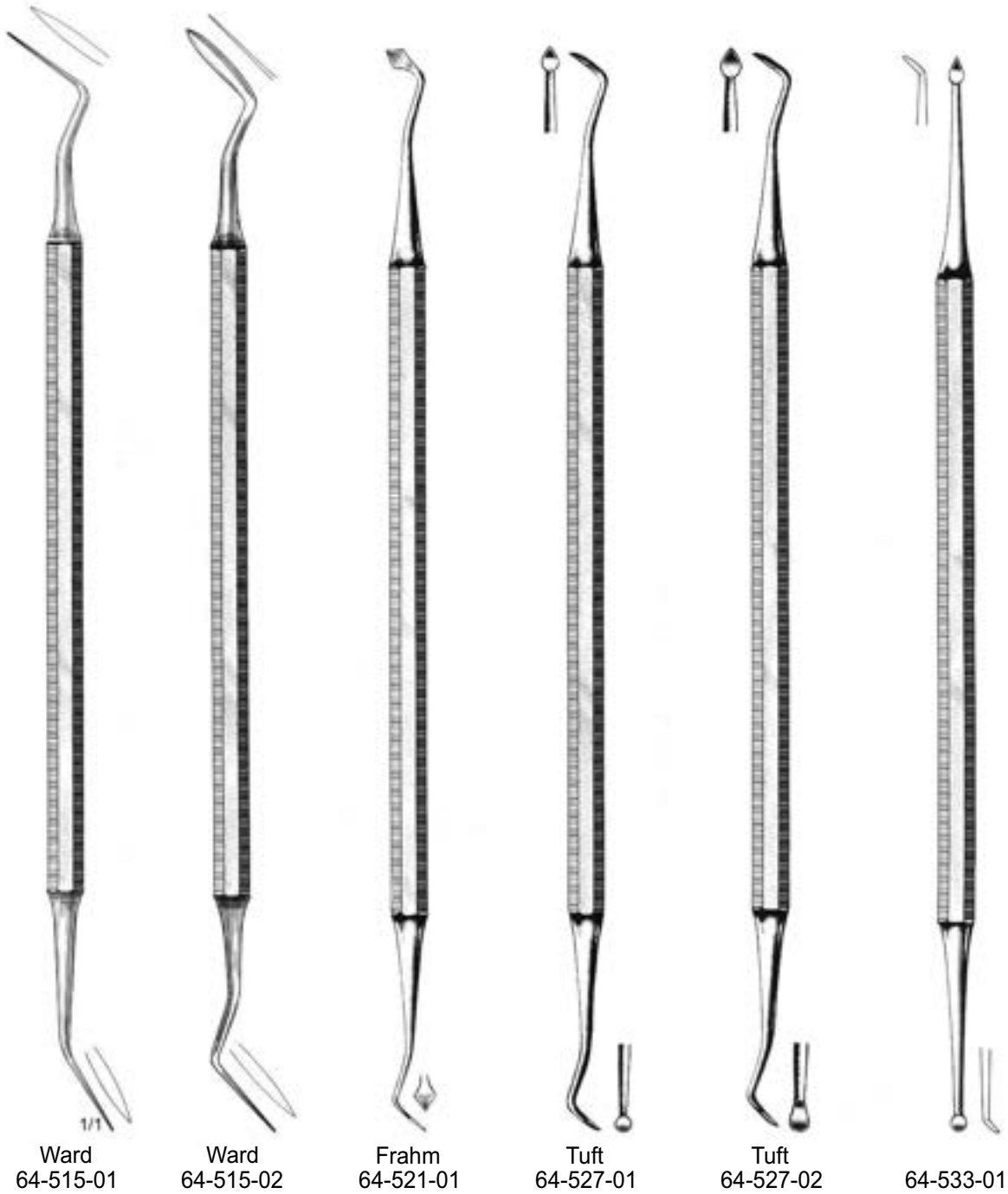
Thomas
64-501-04

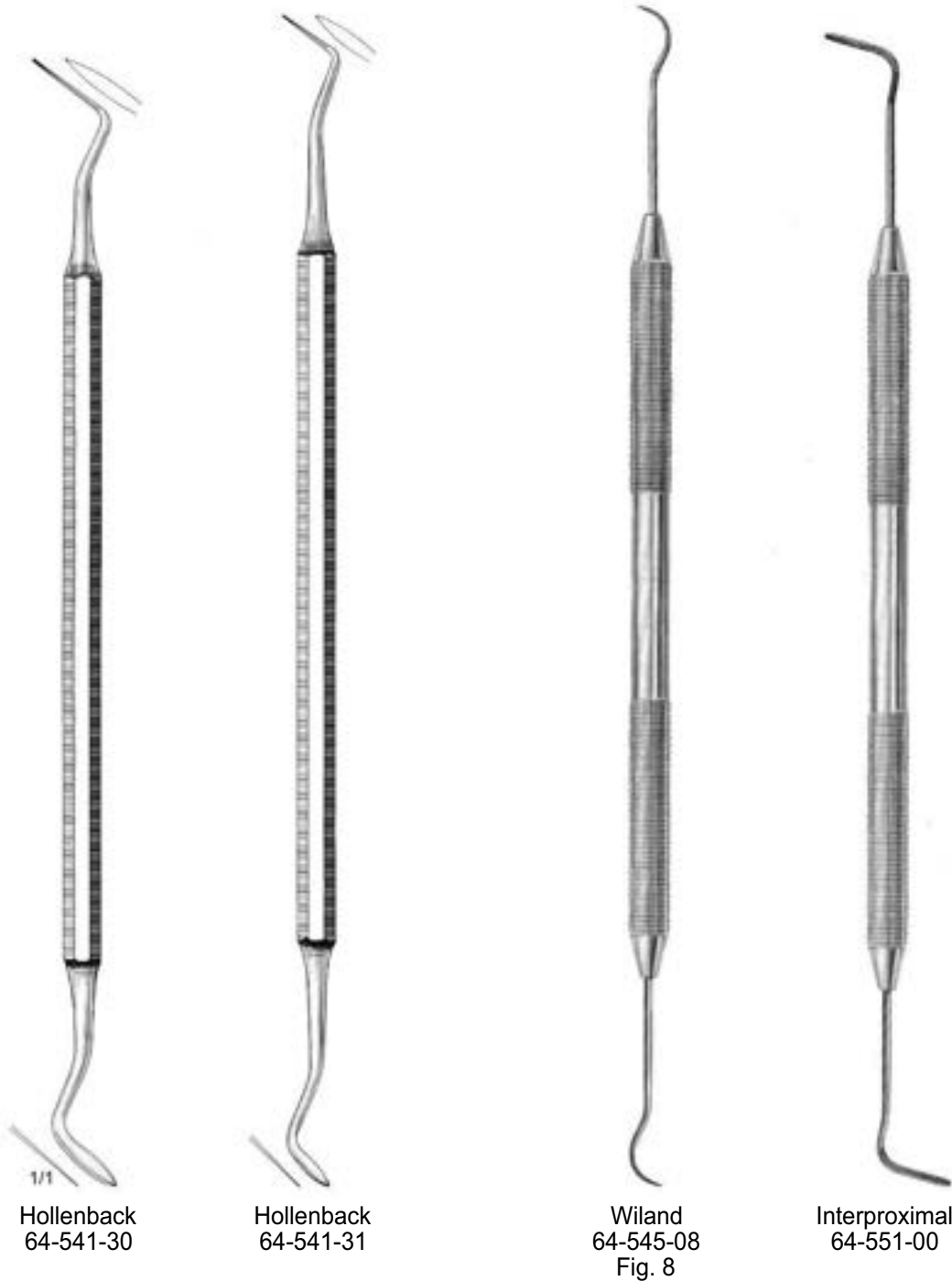


Thomas
64-501-05



Thomas
64-501-06







Hyllin
64-571-01



Zahle
64-575-01



Zahle
64-579-01



Le Cron
64-591-01



Le Cron
64-595-01





1/1
Miller
64-721-15
15 cm



1/1
Sachs
64-725-01
15 cm

acrylic glass



1/1
Mershon
64-729-01



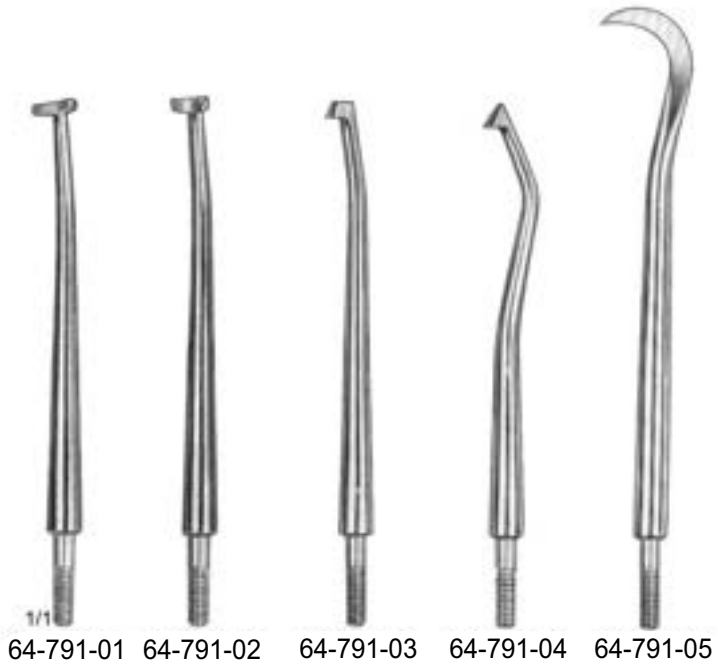
1/1
64-740-01



1/1
Mod. Paris
64-744-01



1/1
64-746-30
10 m / 32 ft
Ø 3 mm



suited for 64-785-01, 64-787-01



65

ca. 65 mm
wooden handle



1/3
65-100-21
21 cm

ca. 70 mm
wooden handle



1/3
65-110-24
24 cm

ca. 60 mm
wooden handle



1/3
65-121-21
21 cm

ca. 110 mm
wooden handle



1/3
65-130-28
28 cm

ca. 110 mm
wooden handle



1/3
65-140-27
27 cm

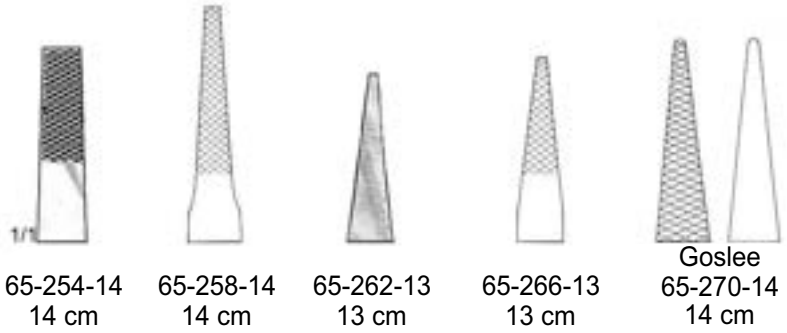
ca. 60 mm
aluminium head, wooden handle



1/3
65-150-23
23.5 cm



1/2
 65-250-15 - 65-274-13



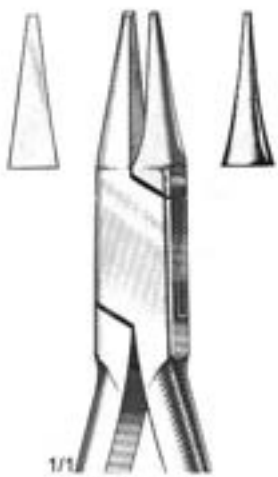
65-254-14
 14 cm

65-258-14
 14 cm

65-262-13
 13 cm

65-266-13
 13 cm

Goslee
 65-270-14
 14 cm



1/1
 65-250-15
 15 cm



65-274-13
 13 cm



1/2
 65-280-11 - 65-288-11



1/1
 65-280-11



65-284-11



65-288-11



65-310-12 - 65-338-14



65-310-12
12.5 cm



65-314-11
11 cm



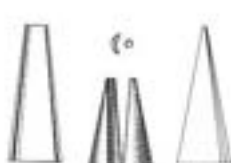
65-318-11
11 cm



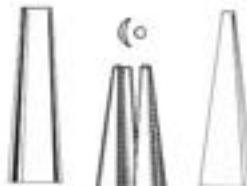
Martin - Diamant
65-322-16
16 cm



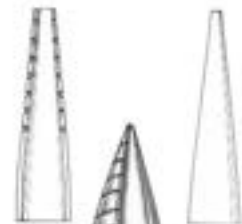
Schwarz
65-326-13
13 cm



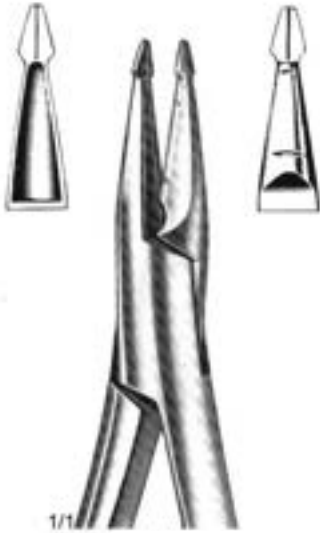
Schwarz
65-330-13
13 cm



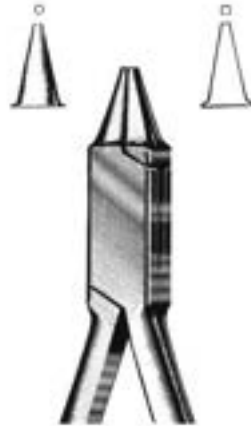
Schwarz
65-334-13
13 cm



Schwarz
65-338-14
14.5 cm



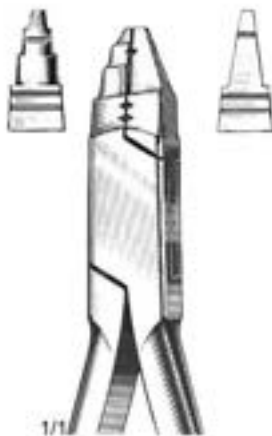
Stadler
65-370-15
15 cm



Angle
65-378-12
12 cm



Adams
65-384-13
13 cm



Young
65-400-13
13 cm



Aderer
65-408-11
11.5 cm



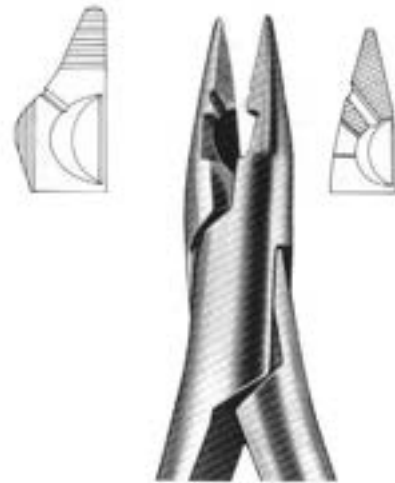
Aderer
65-414-13
13 cm



Waldsachs - Universal
65-500-15
15.5 cm



Universal
65-504-15
15.5 cm



65-508-15
15.5 cm



Furrer
65-600-15
15 cm



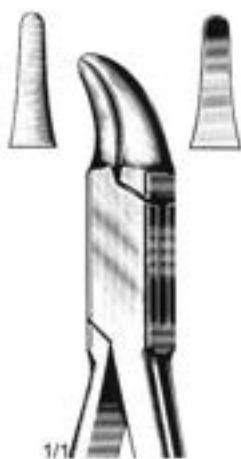
65-608-15
15 cm



How
65-700-14
14 cm



How
65-701-14
14 cm



Reynolds
65-738-13
13 cm



Johnson
65-738-13
13 cm



Abell
65-744-13
13 cm



THANK YOU



CONTACT US



www.pentaxsurgical.com



pentaxsurgical@gmail.com
info@pentaxsurgical.com



+92-328 01 66 200

Visit Alibaba Site:

